

EX-Series®

GratEX®
MoultrEX®
GridEX®

Grating Product Guide

World leaders in the design and supply of Fibreglass Reinforced Plastic (FRP) Access Systems for industry.

The team at Treadwell is excited and proud to be releasing the latest version of the FRP Grating Product Guide to the market.

Treadwell's product range has expanded progressively since our last release of our FRP grating guide and now includes extensive offerings such as GratEX® moulded FRP Grating, MoultrEX® Moultruded FRP Grating and GridEX® FRP Pultruded Grating, Flooring and Stair Treads. These products are offered with an encompassing range of ancillary components and fastenings, as well as floor elevation and embedment products.

Our EX-Series® FRP grating is designed for use in a multitude of environments where the grating may be subjected to continuous spills, electrical dangers, fumes, splashes or submersions. In such demanding environments, FRP grating will out perform the standard traditional grating options. Our FRP grating is available in standard panels or can be customised to specification.

Now with warehouses and distribution centres throughout Australia and New Zealand. Treadwell is your one stop shop for FRP - we stock, we modify and we deliver to ensure that Treadwell is the name you can rely on.

A BRIEF HISTORY

Treadwell Group is one of the most established names in the supply of Access Systems throughout Australia.

Our centrally located Adelaide fabrication facility, coupled with our second to none distribution network across Australia and our commitment to quality and testing, allows our technical staff to provide engineering and design assistance for any project.

With a broad history of installation in a wide range of challenging applications, including industrial process plants, mining applications, marine and coastal environments as well as public infrastructure, Treadwell has the experience to help you specify the right resin systems and products every time.

If you have any unique design problems, chances are we've encountered something similar before. Get in contact today - Freecall **1800 246 800**.

Treadwell Group Pty Ltd

Australia
P 1800 246 800
sales@treadwellgroup.com.au
treadwellgroup.com.au

New Zealand
P 0800 244 600
sales@treadwellgroup.co.nz
treadwellgroup.co.nz

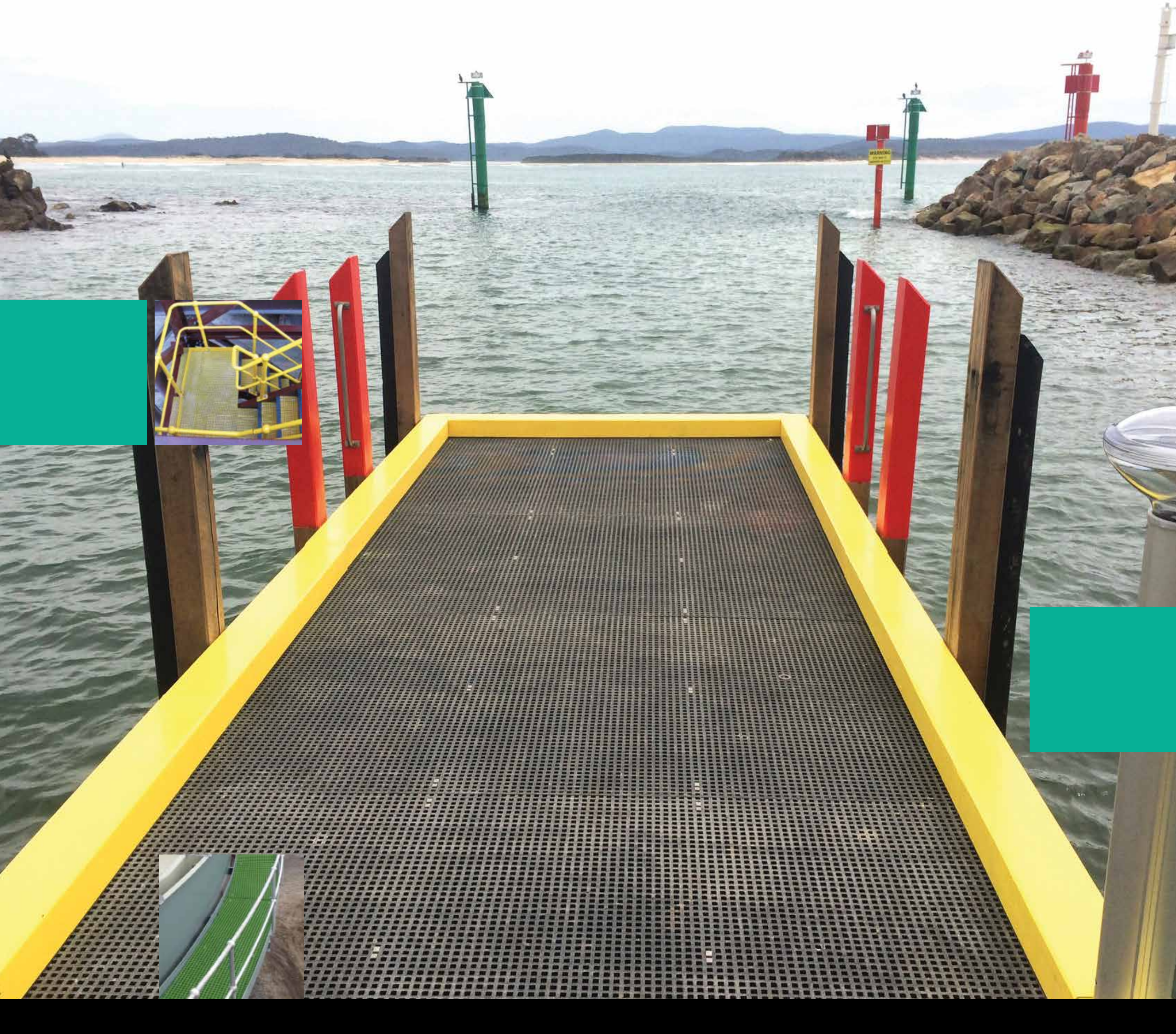

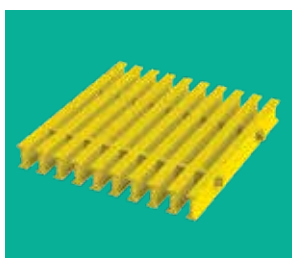

- 04 EX-Series® Grating Key Selection Considerations
- 05 EX-Series® Resin Selection Guide

GratEX®

- 06 GratEX® Moulded Fibreglass Grating
- 07 GratEX® Square Mesh
- 11 GratEX® Heavy Duty Square Mesh
- 13 GratEX® Mini Mesh
- 18 GratEX® Micro Mesh
- 21 GratEX® Rectangular Mesh
- 23 GratEX® Heavy Duty Rectangular Mesh
- 26 GratEX® Solid Surface Mesh
- 30 GratEX® Heavy Duty Solid Surface Mesh
- 32 GratEX® Stair Treads
- 33 GratEX® Landings
- 38 GratEX® Fastening Clips and Installation Methods
- 40 GratEX® Fixing Assembly Combinations
- 45 GratEX® Closed Load Bar Charts

MoultrEX®

- 50 MoultrEX® Moultruded Fibreglass Grating

GridEX®

- 54 GridEX® Pultruded Fibreglass Grating
- 55 GridEX® I Type Grating
- 60 GridEX® T Type Grating
- 63 GridEX® Bar Type Grating
- 65 GridEX® Stair Treads
- 66 GridEX® Installation Methods and Accessories







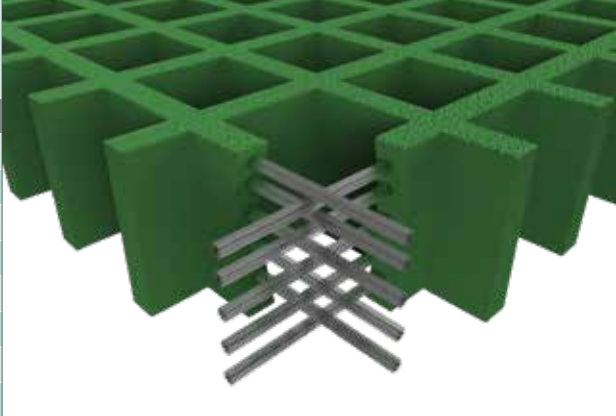
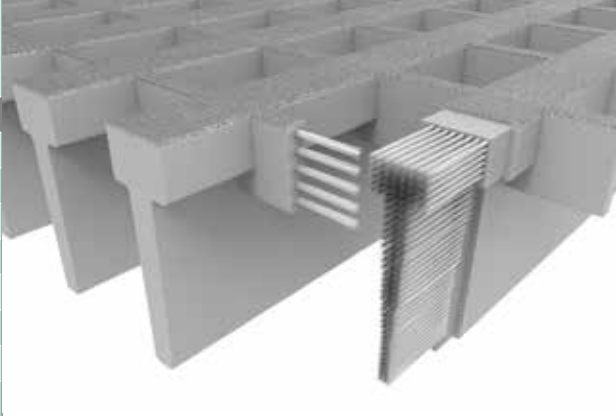

EX-Series®

- 67 P-Series® Phenolic Grating
- 69 Colour Palette
- 71 Anti-Slip Grit Grades
- 72 HygiGR8®
- 74 Conductive Grating
- 75 Terminology
- 76 Installation Suggestions & Tools
- 77 Drafting Information & Manufacturing Tolerances
- 78 Embedment Angle
- 79 StormChief®
- 82 Access Hatches, Handles and Hinge Systems
- 83 Elevated Support Systems
- 85 Appendix 1; Load Data Tables
- 85 Appendix 2: Chemical Resistance Guide
- 90 Appendix 3: GratEX® Ordering Codes
- 92 Appendix 4: MoultrEX® Ordering Codes
- 93 Appendix 5: GridEX® Ordering Codes
- 94 Appendix 6a: GratEX® Fasteners Ordering Information
- 96 Appendix 6b: MoultrEX® Fasteners Ordering Information
- 97 Appendix 6c: GridEX® Fasteners Ordering Information

Disclaimer: The information contained in this Treadwell design guide herein supplied is as a service to our customers and is intended to be used only as a general guide. It is not a substitute for proven engineering practices and designs.

EX-Series® Grating Key Selection Considerations

Treadwell EX-Series® Fibreglass Reinforced Plastic (FRP) grating products are recommended for areas where physical properties are paramount to design and longevity. Treadwell offers a very extensive range of FRP grating products which incorporates three main product systems. Of these three distinct product ranges, there are key differences which you as a user or specifier need to be aware of. The below information outlines for you the key differences and the ideal scenarios in which each of the different types of grating are to be utilised.

GratEX® Moulded FRP Grating					
The perfect solution for areas where excessive amounts of penetrations (i.e. for piping) call for traditional uni-directional spanning products which make it horrendously expensive and inconvenient.					
Characteristic/Application	Rating				
Bi-directional spanning ability	● ● ● ● ●				
Uni-directional spanning ability	● ● ● ● ●				
Chemical Resistance	● ● ● ● ●				
Impact Resistance	● ● ● ● ●				
Weight savings vs. metallic grating	● ● ● ● ●				
Open Area (allowing for air flow & light penetration)	● ● ● ● ●				
Pipe penetrations	● ● ● ● ●				
MoultrEX® Moultruded FRP Grating					
An excellent product choice for those applications where a medium between great product performance over time and great aesthetics are called for, i.e. jetties, marinas, boardwalks and more!					
Characteristic/Application	Rating				
Bi-directional spanning ability	● ● ● ● ●				
Uni-directional spanning ability	● ● ● ● ●				
Chemical Resistance	● ● ● ● ●				
Impact Resistance	● ● ● ● ●				
Weight savings vs. metallic grating	● ● ● ● ●				
Open Area (allowing for air flow & light penetration)	● ● ● ● ●				
Pipe penetrations	● ● ● ● ●				
GridEX® Pultruded FRP Grating					
The ultimate choice for areas where extremely high loadings, or larger spans present a challenge. Such applications include wide walkways, or where equipment needs to be installed on top of grating.					
Characteristic/Application	Rating				
Bi-directional spanning ability	● ● ● ● ●				
Uni-directional spanning ability	● ● ● ● ●				
Chemical Resistance	● ● ● ● ●				
Impact Resistance	● ● ● ● ●				
Weight savings vs. metallic grating	● ● ● ● ●				
Open Area (allowing for air flow & light penetration)	● ● ● ● ●				
Pipe penetrations	● ● ● ● ●				
Legend	Description	Legend	Description	Legend	Description
	Product is compliant to the Australian Disability Access Code AS 1428.		Product conforms to Australian Standard AS 1657 – 2018.		Product weight per square metre.
	Product is pet friendly. Product is heel safe.		Product conforms to Australian Standard AS 1657 – 2018, Clause 4.5.		Product conforms to Australian Standard AS 4586 2013. P5 Slip Resistance

EX-Series® Resin Selection Guide

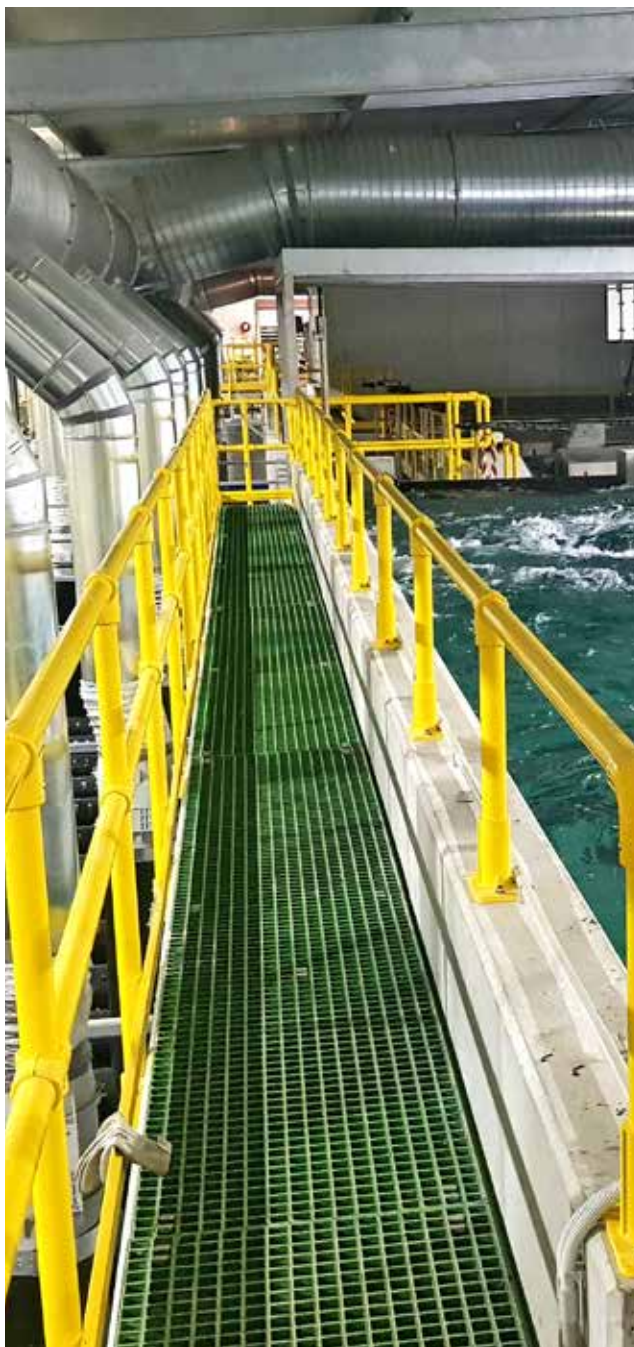

When choosing a resin type for your application, we highly recommend you consult us to ensure that the correct resin is specified. Considerations such as corrosion, environment, temperature, fire resistance, smoke and smoke toxicity requirements must be taken into account, and will dictate which resin system should be utilised for optimum performance over time.

Below is an overview of the resin systems offered in the Access Systems Range.

Options Overview

O-Series® is an architectural grade polyester resin system with an intermediate level of chemical resistance, and is a good choice for commercial or light industrial applications, especially where moisture is prevalent. O-Series® is often utilised for public infrastructure applications where it has been proven to outperform traditional timber decking products. This system is manufactured with fire retardant additives.

I-Series® is a premium isophthalic resin system. This system provides an intermediate level of chemical resistance and is the correct choice for areas subjected to splash and spill contact with harsh chemicals. This system is an excellent general-purpose resin and is a more favourably priced alternative to the vinyl ester system. This system has a flame spread of 25 (Approximately 15) or less.

V-Series® is a vinyl ester resin system that provides the highest chemical resistance offered in the industry and has been developed for use in environments where FRP products are subject to frequent and direct contact with the harshest of chemicals including a broad range of acids and caustics. This system has a flame spread of 25 (Approximately 15) or less.

P-Series® is a phenolic resin system that is designed specifically for use where fire resistance, low smoke and low toxic fumes are critical. P-Series® is typically used in offshore applications and confined spaces where such criteria are an absolute necessity. This system is tested in accordance to ASTM E-84. Various products also conforming to US Coast Guard Approvals, Level 2 and 3, are also offered by Treadwell. This particular resin system has a flame spread rating of 5 and a smoke density rating of 5.

EX-Series® Resin Systems Comparison Chart

	Chemical Resistance	Fire Retardance	Low Smoke	Halogen Free	Temperature Performance
O-Series® Polyester	● ● ●	● ● ● ●	—	—	● ● ●
I-Series® Isophthalic	● ● ● ● ●	● ● ● ● ●	—	—	● ● ● ●
V-Series® Vinylester	● ● ● ● ●	● ● ● ● ●	—	—	● ● ● ● ●
P-Series® Phenolic	● ● ● ●	● ● ● ● ●	● ● ● ●	● ● ● ● ●	● ● ● ● ●

GratEX® Moulded Fibreglass Grating

What is GratEX® Moulded Fibreglass Grating

Treadwell's GratEX® moulded FRP grating is a high strength, single piece construction mesh panel product. Treadwell offers both standard panel sizes as well as the option of custom panels made to order from your drawings, or alternatively, drawings provided by Treadwell's drafting department.

Cost effective GratEX® panels allow for effective on-site fabrication/trimming whilst ensuring that wastage is minimised. Load bearing bars in both directions allow for use without continuous side support and so contribute to cost effectiveness. GratEX® offers all the benefits available with grating made from other materials plus a host of superior benefits unequalled by steel or other metal alternatives.



GratEX® Features and Benefits vs. Traditional Alternatives

	GratEX®	Stainless Steel	Galvanised Steel	Aluminium	Polyurethane
Chemical Resistance	•••••	••••	•	•••	••••
Strength	•••••	•••••	•••••	•••••	•••
Lightweight	•••••	•	•	•••••	•••
Electrical Resistance	•••••	•	•	•	•••••

GratEX® Surface Options

Anti-Slip Surface (Standard). This surface is most commonly used in industrial applications. It is very hard wearing and boasts an extremely effective coefficient of friction (NATA laboratory test report available). Unlike serrated steel, the anti-slip surface does not impact load carrying capacity.

Concave Surface. This is preferred for environments where by-products are commonly caught by serrations, and is hence very often utilised by the food industry. This surface option can also be used for guarding options to allow safe handling/ contact.

Plain Surface. This is a stock option that is widely utilised for guarding and architectural features in a variety of applications. Whilst the aesthetics of the product are improved, the anti-slip properties are not as profound as the other options available.



GTX-133838SS

N

Isometric View

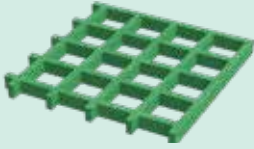

Plan View

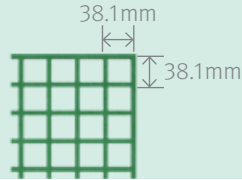

Elevation View

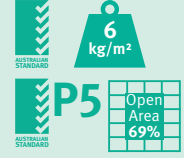
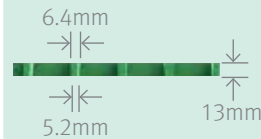

GTX-135050SS

N

Isometric View

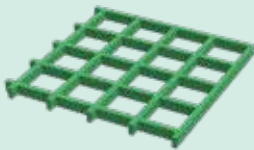

Plan View

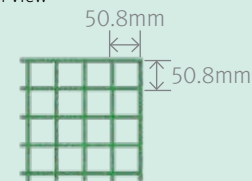

Elevation View

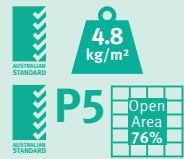
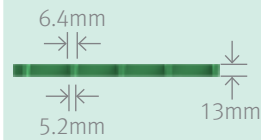

GTX-153838SS

C

Isometric View

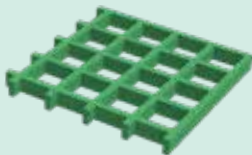

Plan View

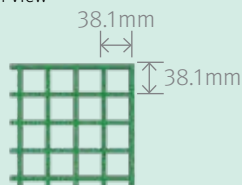

Elevation View

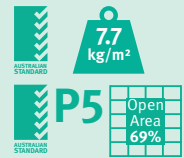

GTX-203838SS

N

Isometric View

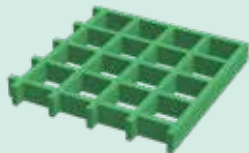

Plan View

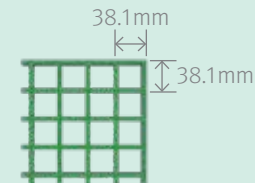

Elevation View

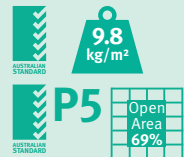

GTX-237979SS

N

Isometric View

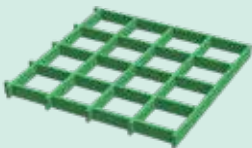

Plan View

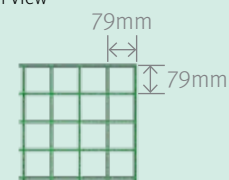

Elevation View

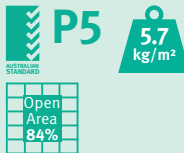
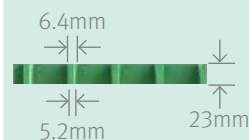

GTX-253838SS

C

Isometric View



Plan View

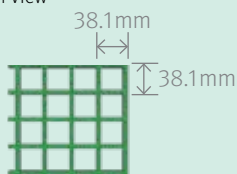

Elevation View

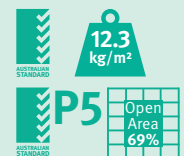
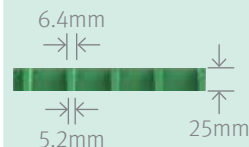

GratEX® Square Mesh

GTX-255050SS

N

Isometric View

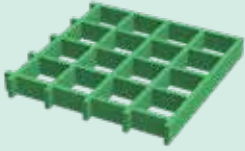

Plan View

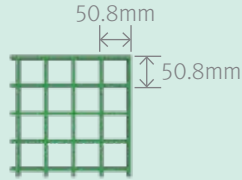

Elevation View

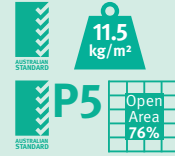
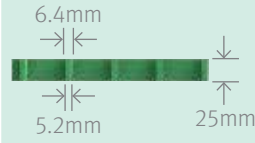

GTX-258383SS

N

Isometric View

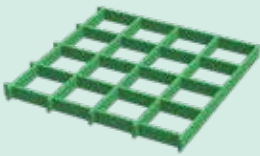

Plan View

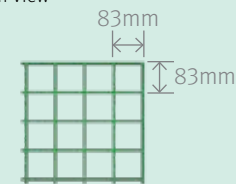

Elevation View

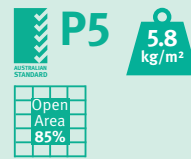
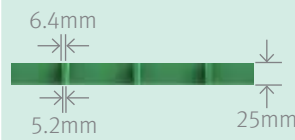

GTX-303838SS

C

Isometric View

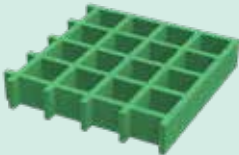

Plan View

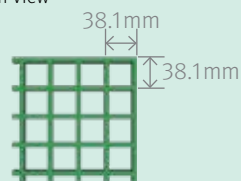

Elevation View

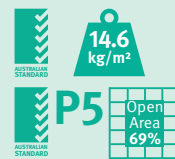
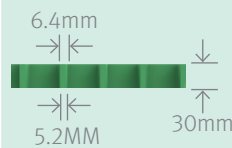

GTX-304040SS

N

Isometric View

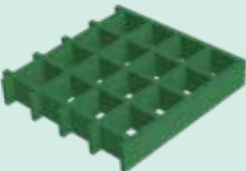

Plan View

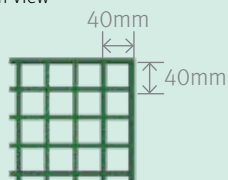

Elevation View

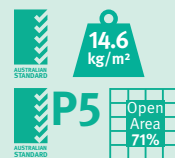
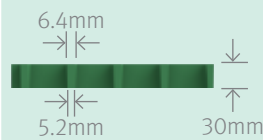

GTX-383838SS

C

Isometric View



Plan View

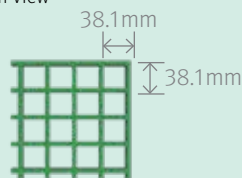

Elevation View

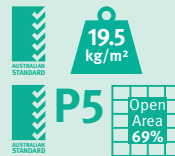
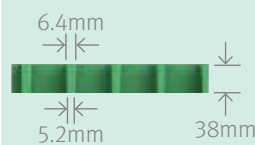

GTX-505050SS

C

Isometric View



Plan View

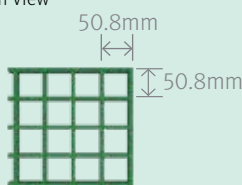

Elevation View

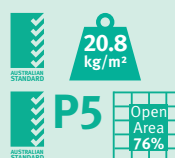
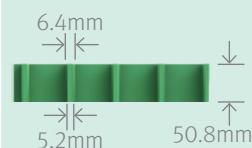

Safe Load & Deflection Charts (mm) - Uniform and Concentrated Line Loads

Mesh Grid	Load Bar Details	Span (mm)	Load Type	Uniform load – ΔU (kN/m ²) – Deflection (mm) Concentrated line load – ΔC (kN/m) – Deflection (mm)															
				3	5	8	10	15	20	25	30	40	50	60	80	90	100		
GTX-203838SS																			
38X38	20X6	400	ΔU	0.69	1.14	1.83	2.29	3.43	4.58	5.72	6.87	9.16	11.45						
			ΔC	3.28	5.47	8.76	10.95												
		600	ΔU	3.65	6.08	9.73	12.16												
			ΔC	10.35															
GTX-253838SS																			
38X38	25X6	400	ΔU	0.36	0.60	0.96	1.20	1.80	2.40	3.01	3.61	4.81	6.01	7.21	9.62	10.82	12.02		
			ΔC	1.52	2.54	4.06	5.08	7.62	10.16	12.70	15.24								
		600	ΔU	1.81	3.02	4.82	6.03	9.05	12.06	15.08	18.09								
			ΔC	4.86	8.10	12.96													
		800	ΔU	5.70	9.50														
			ΔC	11.28															
GTX-303838SS																			
38X38	30X6	400	ΔU	0.22	0.36	0.58	0.73	1.09	1.46	1.82	2.19	2.92	3.65	4.37	5.83	6.56	7.29		
			ΔC	0.96	1.59	2.55	3.19	4.78	6.38	7.97	9.57	12.76	15.95						
		600	ΔU	1.03	1.71	2.74	3.42	5.13	6.84	8.56	10.27	13.69							
			ΔC	2.79	4.64	7.43	9.29	13.93											
		800	ΔU	3.16	5.26	8.42	10.52												
			ΔC	6.24	10.40														
GTX-383838SS																			
38X38	38X6	400	ΔU	0.11	0.19	0.30	0.37	0.56	0.75	0.94	1.12	1.50	1.87	2.25	3.00	3.37	3.74		
			ΔC	0.48	0.80	1.28	1.60	2.39	3.19	3.99	4.79	6.38	7.98	9.57	12.77	14.36	15.96		
		600	ΔU	0.55	0.92	1.48	1.85	2.77	3.70	4.62	5.54	7.39	9.24	11.09	14.79	16.63	18.48		
			ΔC	1.51	2.52	4.03	5.03	7.55	10.06	12.58	15.09								
		800	ΔU	1.74	2.89	4.63	5.79	8.68	11.58	14.47	17.37								
			ΔC	3.49	5.82	9.31	11.63	17.45											
		1000	ΔU	4.22	7.04	11.26	14.07												
			ΔC	6.74	11.23	17.96													
		1200	ΔU	8.74	14.56														
			ΔC	11.56															
		GTX-505050SS																	
		50X50	50X6	400	ΔU	0.08	0.14	0.22	0.28	0.41	0.55	0.69	0.83	1.10	1.38	1.66	2.21	2.49	2.76
ΔC	0.32				0.53	0.85	1.06	1.60	2.13	2.66	3.19	4.26	5.32	6.38	8.51	9.57	10.64		
600	ΔU			0.34	0.57	0.91	1.13	1.70	2.26	2.83	3.40	4.53	5.66	6.79	9.05	10.19	11.32		
	ΔC			0.89	1.49	2.38	2.97	4.46	5.94	7.43	8.91	11.89	14.86	17.83	23.77	26.74			
800	ΔU			0.98	1.64	2.63	3.28	4.92	6.56	8.21	9.85	13.13	16.41	19.69	26.26				
	ΔC			1.96	3.26	5.22	6.53	9.79	13.06	16.32	19.59	26.12							
1000	ΔU			2.30	3.84	6.14	7.68	11.52	15.36	19.20	23.04								
	ΔC			3.69	6.14	9.83	12.29	18.43	24.58										
1200	ΔU			4.67	7.78	12.44	15.55	23.33											
	ΔC			6.24	10.40	16.64	20.80												
1400	ΔU			8.52	14.20	22.71													
	ΔC			9.78	16.31	26.09													

GratEX® Square Mesh Specification

General

1.0 Scope

- 1.1 The grating shall conform to the material and fabrication requirements as per this specification.

2.0 Standards/Related documents

- 2.1 The grating system shall conform to the applicable sections of:
- 2.1.1 ASTM E84 Surface Burning Characteristics of Building Materials
 - 2.1.2 ASTM D635 Rate of Burning and/or Extent and Time of Burning of Self-Supporting Plastics in a Horizontal Position.

3.0 Design Criteria

- 3.1 The design criteria of the fibreglass products (FRP) shall be in accordance with governing building codes and generally accepted standards in the FRP industry.
- 3.2 Design live loads shall be of ... kPa uniformly distributed load (or as per building code if more stringent) with a maximum deflection of ... mm at the centre of a single span according to product specifications.

4.0 Submittals

- 4.1 Shop drawings of all fabricated grating panels shall be submitted by Treadwell (unless provided by the client) displaying clearly material sizes, types, styles, product codes and including types and sizes of fasteners as well as a layout if required.
- 4.2 Technical data and sample pieces can also be submitted if required.

5.0 Quality Assurance

Quality surrounds every aspect of Treadwell's commitment to our superior products and efficiency. Treadwell's quality assurance strictly adheres to the high quality control standards placed to conform to relevant specifications, codes, Australian Standards and contractual requirements in a timely manner.

6.0 Product Delivery and Storage

- 6.1 All grating and components or ancillary items shall be fabricated as per the design and piece marked to design drawings.
- 6.2 All manufactured materials shall be delivered in unbroken packages.

Product System

7.0 Manufacturing Process

- 7.1 All fibreglass (FRP) items listed under this section shall be constructed from fibreglass reinforcement and resin of the quality necessary to meet the design requirements and dimensions as specified.
- 7.2 Fibreglass reinforcement shall be continuous roving and shall be in sufficient quantities as required for the application.
- 7.3 Resins shall be ... (refer to page 5) with chemical formulations as necessary to provide the corrosion resistance, strength and any other physical properties as required.
- 7.4 All finished surfaces to be smooth, resin-rich, free of voids and without dry spots, cracks or unreinforced areas and all fibreglass reinforcement shall be well covered with resin to protect against exposure due to weather or wear.
- 7.5 All fibreglass (FRP) items shall be EITHER non-fire retardant OR have a tested flame spread rating of 25 or less when tested in accordance with the ASTM E84 Tunnel Test.
- 7.6 Contact Treadwell regarding specification data relative to products conforming to ASTM D635.

- 7.7 All metal accessories shall be manufactured from (304 or 316) Stainless Steel, 2205 Duplex Stainless Steel, 2507 Super Duplex Stainless Steel, hot dipped galvanised steel or aluminium.
- 7.8 Load bars shall be joined with notched cross bars via interlocking methods and the use of chemical bonding.
- 7.9 The fibreglass reinforcement content shall be maintained at 65% (by weight) so as to achieve maximum loading capacity.
- 7.10 All fibreglass material shall have an ultraviolet light inhibiting chemical additive to resist UV degradation.
- 7.11 Grating shall be manufactured with a concave profile on top of each bar OR an anti-slip Aluminium Oxide surface to provide optimum slip resistance.

8.0 Acceptable Manufacturer

The fibreglass underfoot moulded grating system shall be manufactured by Treadwell Group Pty Ltd of Australia.

Ordering Information

Code

1. Nominate the type of grating required **GTX = GratEX® Moulded Grating**

Note: This section of the coding is typically separated from the next section of the coding by a dash (-)

2. Nominate the depth (mm) required **13, 15, 20, 23, 25, 30, 38 and 50**

3. Nominate the load bar centres required **3838 = 38mm x 38mm**
4040 = 40mm x 40mm
5050 = 50mm x 50mm
7979 = 79mm x 79mm
8383 = 83mm x 83mm

4. Nominate the mesh type required **SS = Standard Square Mesh**

Note: This section of the coding is typically separated from the next section of the coding by a dash (-)

5. Specify the resin, material or type (see page 6) **O = O-Series®**
I = I-Series®
V = V-Series®
P = P-Series®

6. Specify the colour required **TY = Treadwell Yellow**
DG = Dark Grey
LG = Light Grey
TG = Treadwell Green
CH = Charcoal
CC = Custom Colour

*In which instance a code and name of the selected colour must be mentioned within the description.

7. Specify the surface style required **G1 = Barefoot Grade (Grit) Anti-Slip**
G2 = Commercial Grade (Grit) Anti-Slip
G3 = Industrial Grade (Grit) Anti-Slip
G4 = Marine Grade (Grit) Anti-Slip
CO = Concave
PL = Plain (Smooth)

Note: The next section of coding is separated by a dash (-), it isn't required for custom jobs as GratEX® is available in a variety of size panels to suit applications.

8. Nominate the panel size required **01 = 1225mm x 3665mm**
02 = 920mm x 3055mm
03 = 610mm x 3665mm
04 = 1225mm x 4040mm

Please refer to Appendix 3: GratEX® Ordering Codes - page 82

N Non-Stocked Item **C** Commonly Stocked Item

GratEX® Heavy Duty Square Mesh

GTX-353838HS

N

<p>Isometric View</p>	<p>Plan View</p>	<p>Elevation View</p>	
-----------------------	------------------	-----------------------	--

GTX-503838HS

N

<p>Isometric View</p>	<p>Plan View</p>	<p>Elevation View</p>	
-----------------------	------------------	-----------------------	--

GTX-603838HS

N

<p>Isometric View</p>	<p>Plan View</p>	<p>Elevation View</p>	
-----------------------	------------------	-----------------------	--

Mesh Grid	Load Bar Details	Span (mm)	Load Type	Uniform load – ΔU (kN/m²) – Deflection (mm) Concentrated line load – ΔC (kN/m) – Deflection (mm)															
				3	5	8	10	15	20	25	30	40	50	60	80	90	100		

GTX-503838HS

38x38	50x10	200	ΔU	0.01	0.01	0.02	0.02	0.03	0.04	0.05	0.06	0.08	0.10	0.12	0.16	0.18	0.20
			ΔC	0.02	0.03	0.05	0.06	0.09	0.11	0.14	0.17	0.23	0.29	0.34	0.46	0.51	0.57
		400	ΔU	0.04	0.07	0.11	0.14	0.22	0.29	0.36	0.43	0.57	0.72	0.86	1.15	1.29	1.43
			ΔC	0.12	0.20	0.31	0.39	0.59	0.78	0.98	1.17	1.56	1.95	2.34	3.12	3.52	3.91
		600	ΔU	0.17	0.28	0.45	0.56	0.85	1.13	1.41	1.69	2.26	2.82	3.39	4.52	5.08	5.65
			ΔC	0.38	0.64	1.02	1.28	1.91	2.55	3.19	3.83	5.11	6.38	7.66	10.21	11.49	12.76
		800	ΔU	0.48	0.80	1.29	1.61	2.41	3.21	4.02	4.82	6.43	8.03	9.64	12.85	14.46	16.07
			ΔC	0.90	1.50	2.39	2.99	4.49	5.98	7.48	8.97	11.96	14.95	17.94	23.93	26.92	
		1000	ΔU	1.12	1.86	2.98	3.72	5.58	7.44	9.30	11.16	14.88	18.61	22.33			
			ΔC	1.74	2.90	4.65	5.81	8.71	11.62	14.52	17.43	23.24					
		1200	ΔU	2.25	3.74	5.99	7.49	11.23	14.98	18.72	22.47						
			ΔC	3.00	5.00	8.01	10.01	15.01	20.02	25.02							
		1400	ΔU	4.09	6.81	10.90	13.62	20.43									
			ΔC	4.76	7.93	12.69	15.87	23.80									

GTX-603838HS

38x38	60x10	200	ΔU	0.00	0.00	0.00	0.01	0.01	0.01	0.01	0.02	0.02	0.03	0.03	0.04	0.05	0.05
			ΔC	0.01	0.02	0.03	0.04	0.06	0.08	0.10	0.13	0.17	0.21	0.25	0.33	0.38	0.42
		400	ΔU	0.02	0.03	0.05	0.06	0.09	0.12	0.15	0.18	0.24	0.30	0.36	0.48	0.54	0.60
			ΔC	0.07	0.12	0.19	0.24	0.36	0.48	0.59	0.71	0.95	1.19	1.43	1.90	2.14	2.38
		600	ΔU	0.08	0.14	0.22	0.28	0.42	0.56	0.70	0.84	1.12	1.40	1.67	2.23	2.51	2.79
			ΔC	0.22	0.37	0.59	0.74	1.11	1.49	1.86	2.23	2.97	3.71	4.46	5.94	6.68	7.43
		800	ΔU	0.26	0.43	0.69	0.86	1.29	1.71	2.14	2.57	3.43	4.29	5.14	6.86	7.71	8.57
			ΔC	0.51	0.86	1.37	1.71	2.57	3.42	4.28	5.13	6.84	8.55	10.26	13.68	15.40	17.11
		1000	ΔU	0.62	1.03	1.65	2.06	3.10	4.13	5.16	6.19	8.26	10.32	12.39	16.51	18.58	20.64
			ΔC	0.99	1.65	2.64	3.30	4.94	6.59	8.24	9.89	13.18	16.48	19.78	26.37	29.66	
		1200	ΔU	1.27	2.12	3.40	4.25	6.37	8.50	10.62	12.75	16.99	21.24	25.49			
			ΔC	1.70	2.83	4.52	5.65	8.48	11.31	14.13	16.96	22.61	28.27				
		1400	ΔU	2.35	3.92	6.27	7.84	11.75	15.67	19.59	23.51						
			ΔC	2.68	4.47	7.15	8.94	13.40	17.87	22.34	26.81						
		1600	ΔU	4.00	6.66	10.66	13.33	19.99	26.66								
			ΔC	3.99	6.65	10.64	13.30	19.95	26.60								

GratEX® Heavy Duty Square Mesh Specification

General

1.0 Scope

- 1.1 The grating shall conform to the material and fabrication requirements as per this specification.

2.0 Standards/Related documents

- 2.1 The grating system shall conform to the applicable sections of:
- 2.1.1 ASTM E84 Surface Burning Characteristics of Building Materials
 - 2.1.2 ASTM D635 Rate of Burning and/or Extent and Time of Burning of Self-Supporting Plastics in a Horizontal Position.

3.0 Design Criteria

- 3.1 The design criteria of the fibreglass products (FRP) shall be in accordance with governing building codes and generally accepted standards in the FRP industry.
- 3.2 Design live loads shall be of ... kPa uniformly distributed load (or as per building code if more stringent) with a maximum deflection of ... mm at the centre of a single span according to product specifications.

4.0 Submittals

- 4.1 Shop drawings of all fabricated grating panels shall be submitted by Treadwell (unless provided by the client) displaying clearly material sizes, types, styles, product codes and including types and sizes of fasteners as well as a layout if required.
- 4.2 Technical data and sample pieces can also be submitted if required.

5.0 Quality Assurance

Quality surrounds every aspect of Treadwell's commitment to our superior products and efficiency. Treadwell's quality assurance strictly adheres to the high quality control standards placed to conform to relevant specifications, codes, Australian Standards and contractual requirements in a timely manner.

6.0 Product Delivery and Storage

- 6.1 All grating and components or ancillary items shall be fabricated as per the design and piece marked to design drawings.
- 6.2 All manufactured materials shall be delivered in unbroken packages.

Product System

7.0 Manufacturing Process

- 7.1 All fibreglass (FRP) items listed under this section shall be constructed from fibreglass reinforcement and resin of the quality necessary to meet the design requirements and dimensions as specified.
- 7.2 Fibreglass reinforcement shall be continuous roving and shall be in sufficient quantities as required for the application.
- 7.3 Resins shall be ... (refer to page 5) with chemical formulations as necessary to provide the corrosion resistance, strength and any other physical properties as required.
- 7.4 All finished surfaces to be smooth, resin-rich, free of voids and without dry spots, cracks or unreinforced areas and all fibreglass reinforcement shall be well covered with resin to protect against exposure due to weather or wear.
- 7.5 All fibreglass (FRP) items shall be EITHER non-fire retardant OR have a tested flame spread rating of 25 or less when tested in accordance with the ASTM E84 Tunnel Test.
- 7.6 Contact Treadwell regarding specification data relative to products conforming to ASTM D635.

- 7.7 All metal accessories shall be manufactured from (304 or 316) Stainless Steel, 2205 Duplex Stainless Steel, 2507 Super Duplex Stainless Steel, hot dipped galvanised steel or aluminium.
- 7.8 Load bars shall be joined with notched cross bars via interlocking methods and the use of chemical bonding.
- 7.9 The fibreglass reinforcement content shall be maintained at 65% (by weight) so as to achieve maximum loading capacity.
- 7.10 All fibreglass material shall have an ultraviolet light inhibiting chemical additive to resist UV degradation.
- 7.11 Grating shall be manufactured with a concave profile on top of each bar OR an anti-slip Aluminium Oxide surface to provide optimum slip resistance.

8.0 Acceptable Manufacturer

The fibreglass underfoot moulded grating system shall be manufactured by Treadwell Group Pty Ltd of Australia.

Ordering Information

Code

1. Nominate the type of grating required **GTX = GratEX® Moulded Grating**

Note: This section of the coding is typically separated from the next section of the coding by a dash (-)

2. Nominate the depth (mm) required **35 50 and 60**
3. Nominate the load bar centres required **3838 = 38mm x 38mm**
4. Nominate the mesh type required **HS = Heavy Duty Square Mesh**

Note: This section of the coding is typically separated from the next section of the coding by a dash (-)

5. Specify the resin, material or type (see page 6) **O = O-Series®
I = I-Series®
V = V-Series®
P = P-Series®**
6. Specify the colour required **TY = Treadwell Yellow
DG = Dark Grey
LG = Light Grey
TG = Treadwell Green
CH = Charcoal
CC = Custom Colour**
- *In which instance a code and name of the selected colour must be mentioned within the description.
7. Specify the surface style required **G1 = Barefoot Grade (Grit) Anti-Slip
G2 = Commercial Grade (Grit) Anti-Slip
G3 = Industrial Grade (Grit) Anti-Slip
G4 = Marine Grade (Grit) Anti-Slip
CO = Concave
PL = Plain (Smooth)**

Note: The next section of coding is separated by a dash (-), it isn't required for custom jobs as GratEX® is available in a variety of size panels to suit applications.

8. Nominate the panel size required **01 = 1225 mm x 3665 mm
02 = 920 mm x 3055 mm**

Please refer to Appendix 3: GratEX® Ordering Codes - page 82

N Non-Stocked Item **C** Commonly Stocked Item

GTX-221919M1 N			
<p>Isometric View</p>	<p>Plan View</p>	<p>Elevation View</p>	<p>14.8 kg/m²</p> <p>Open Area 44%</p>
GTX-251919M1 N			
<p>Isometric View</p>	<p>Plan View</p>	<p>Elevation View</p>	<p>16.8 kg/m²</p> <p>Open Area 44%</p>
GTX-301919M1 C			
<p>Isometric View</p>	<p>Plan View</p>	<p>Elevation View</p>	<p>18 kg/m²</p> <p>Open Area 44%</p>
GTX-381919M1 C			
<p>Isometric View</p>	<p>Plan View</p>	<p>Elevation View</p>	<p>23.5 kg/m²</p> <p>Open Area 44%</p>

Benefits of FRP



No Hot Work or Welding Required

FRP is very simply modified or fabricated on site with easy to use hand tools. These can be done without the hassle of first needing to obtain hot work permits.



Light Weight, High Strength & Easy Installation

Treadwell 's FRP products and systems are lightweight and very manageable. FRP has specific gravity one quarter that of steel and two thirds of aluminium.



Environmentally Sound

Related to the lightweight, low need for maintenance and long design life of FRP, the reduced lifecycle cost and environmental footprint are highly sought after characteristics in the modern world. Continual resin formulation fine tuning and development can further raise this environmental profile of composites.

GratEX® Mini Mesh

GTX-502525M1 C

<p>Isometric View</p>	<p>Plan View</p>	<p>Elevation View</p>	<p>28.5 kg/m² Open Area 47%</p>
-----------------------	------------------	-----------------------	--

GTX-142020M1 N

<p>Isometric View</p>	<p>Plan View</p>	<p>Elevation View</p>	<p>10.5 kg/m² Open Area 42%</p>
-----------------------	------------------	-----------------------	--

GTX-222020M1 C

<p>Isometric View</p>	<p>Plan View</p>	<p>Elevation View</p>	<p>14.8 kg/m² Open Area 42%</p>
-----------------------	------------------	-----------------------	--



EX-Series® Integral Edge Banding

Treadwell sets the highest standards for FRP edge banding without compromise. Treadwell offers specifiers a flexibility in design and finishes, allowing projects that consistent finish that impresses. Each project is accurately cut with computer aids before the required surface option is applied. This allows for an ultimate seamless finish that boasts quality and will endure. So much so that Treadwell guarantees this edge banding lasts up to 15 years. Rest assured of your design's longevity with Treadwell's capability in professional edge banding.

GTX-252020M1

N

Isometric View

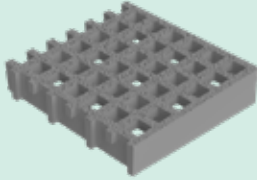

Plan View

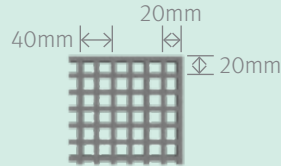

Elevation View

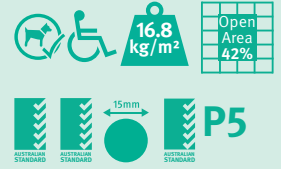
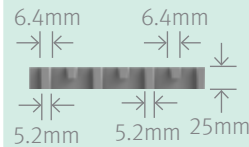

GTX-302020M1

C

Isometric View

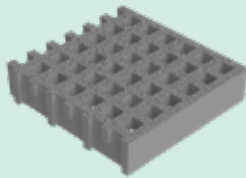

Plan View

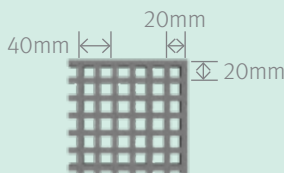

Elevation View

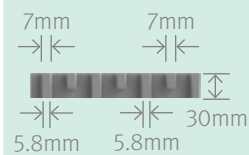

GTX-382020M1

C

Isometric View

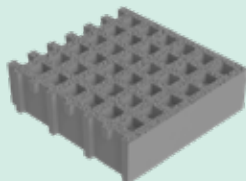

Plan View

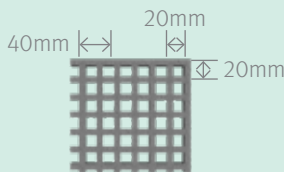

Elevation View

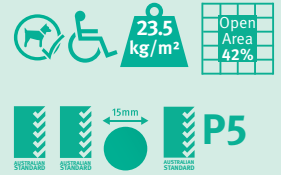
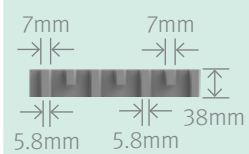

EnviroTREAD™ Recreational Public Infrastructure

Treadwell has given public recreational infrastructure a new direction with EnviroTREAD™.

With the benefits of FRP in the form of grating, handrails and structural profiles, Treadwell brings life through EnviroTREAD™ to boardwalks, viewing platforms, public access, bridges, shelters and more.

Durable, high strength, corrosion resistant and aesthetically pleasing, EnviroTREAD™ prolongs the design life of any construction wherever it is, always reaching new heights.



GratEX® Mini Mesh

Safe Load & Deflection Charts (mm) - Uniform and Concentrated Line Loads

Mesh Grid	Load Bar Details	Span (mm)	Load Type	Uniform load – ΔU (kN/m ²) – Deflection (mm) Concentrated line load – ΔC (kN/m) – Deflection (mm)															
				3	5	8	10	15	20	25	30	40	50	60	80	90	100		
GTX-222020M1																			
40X40 / 20X20	22/9X7	200	ΔU	0.07	0.12	0.19	0.24	0.37	0.49	0.61	0.73	0.97	1.22	1.46	1.95	2.19	2.44		
			ΔC	0.78	1.30	2.09	2.61	3.91	5.21	6.52	7.82	10.43							
		400	ΔU	0.62	1.04	1.66	2.07	3.11	4.14	5.18	6.21	8.28	10.35						
			ΔC	2.58	4.31	6.89	8.62	12.92											
		600	ΔU	2.61	4.35	6.96	8.70	13.04											
			ΔC	7.13	11.88														
		800	ΔU	7.95															
			ΔC																
		GTX-251919M1																	
		38X38 / 19X19	25/9X6	200	ΔU	0.05	0.08	0.13	0.16	0.24	0.32	0.40	0.48	0.63	0.79	0.95	1.27	1.43	1.58
ΔC	0.51				0.85	1.36	1.69	2.54	3.39	4.24	5.08	6.78	8.47	10.17	13.56				
400	ΔU			0.40	0.67	1.08	1.35	2.02	2.69	3.37	4.04	5.38	6.73	8.08	10.77	12.11	13.46		
	ΔC			1.68	2.80	4.48	5.60	8.40	11.20	14.00									
600	ΔU			1.70	2.83	4.52	5.65	8.48	11.31	14.13									
	ΔC			4.64	7.73	12.36													
800	ΔU			5.17	8.62	13.79													
	ΔC			10.50	17.49														
1000	ΔU			12.69															
	ΔC			20.38															
GTX-301919M1																			
38X38 / 19X19	30 / 12X7			200	ΔU	0.01	0.02	0.04	0.04	0.07	0.09	0.11	0.13	0.18	0.22	0.27	0.36	0.40	0.45
		ΔC	0.17		0.28	0.44	0.56	0.83	1.11	1.39	1.67	2.22	2.78	3.34	4.45	5.01	5.56		
		400	ΔU	0.17	0.28	0.46	0.57	0.85	1.14	1.42	1.71	2.28	2.85	3.42	4.56	5.13	5.70		
			ΔC	0.77	1.28	2.04	2.55	3.83	5.11	6.38	7.66	10.22	12.77						
		600	ΔU	0.82	1.37	2.20	2.75	4.12	5.49	6.86	8.24	10.98	13.73						
			ΔC	2.23	3.72	5.95	7.43	11.15											
		800	ΔU	2.56	4.26	6.82	8.52	12.79											
			ΔC	4.99	8.32	13.31													
		1000	ΔU	6.19	10.32														
			ΔC	9.48															
		1200	ΔU	12.78															
			ΔC	16.14															
		GTX-381919M1																	
		38X38 / 19X19	38/9X7	200	ΔU	0.01	0.02	0.03	0.03	0.05	0.07	0.09	0.10	0.14	0.17	0.21	0.28	0.31	0.34
ΔC	0.07				0.11	0.18	0.22	0.34	0.45	0.56	0.67	0.90	1.12	1.34	1.79	2.01	2.24		
400	ΔU			0.10	0.17	0.28	0.35	0.52	0.70	0.87	1.04	1.39	1.74	2.09	2.78	3.13	3.48		
	ΔC			0.39	0.65	1.03	1.29	1.94	2.58	3.23	3.87	5.16	6.45	7.74	10.32	11.61	12.90		
600	ΔU			0.47	0.78	1.26	1.57	2.35	3.14	3.92	4.71	6.28	7.85	9.42	12.56	14.13	15.70		
	ΔC			1.21	2.02	3.23	4.04	6.06	8.09	10.11	12.13	16.17							
800	ΔU			1.43	2.38	3.80	4.75	7.13	9.50	11.88	14.25	19.01							
	ΔC			2.80	4.66	7.46	9.32	13.99	18.65										
1000	ΔU			3.41	5.68	9.09	11.36	17.04											
	ΔC			5.39	8.99	14.38	17.98												
1200	ΔU			6.99	11.65	18.63													
	ΔC			9.25	15.42														
GTX-502525M1																			
40X40 / 20X20	50X9 12X7			200	ΔU	0.01	0.01	0.02	0.02	0.03	0.04	0.05	0.06	0.08	0.10	0.12	0.16	0.18	0.20
		ΔC	0.06		0.11	0.17	0.21	0.32	0.43	0.53	0.64	0.85	1.07	1.28	1.71	1.92	2.13		
		400	ΔU	0.05	0.08	0.14	0.17	0.25	0.34	0.42	0.51	0.68	0.85	1.02	1.36	1.53	1.70		
			ΔC	0.21	0.35	0.56	0.71	1.06	1.41	1.76	2.12	2.82	3.53	4.23	5.64	6.35	7.05		
		600	ΔU	0.21	0.36	0.57	0.71	1.07	1.42	1.78	2.14	2.85	3.56	4.27	5.70	6.41	7.12		
			ΔC	0.58	0.97	1.56	1.95	2.92	3.89	4.86	5.84	7.78	9.73	11.68	15.57	17.51	19.46		
		800	ΔU	0.65	1.09	1.74	2.17	3.26	4.34	5.43	6.51	8.68	10.85	13.02	17.36	19.53			
			ΔC	1.32	2.20	3.52	4.41	6.61	8.81	11.01	13.22	17.62							
		1000	ΔU	1.60	2.66	4.26	5.33	7.99	10.65	13.32	15.98	21.31							
			ΔC	2.57	4.28	6.84	8.55	12.83	17.11	21.39									
		1200	ΔU	3.37	5.61	8.98	11.22	16.84	22.45										
			ΔC	4.46	7.43	11.89	14.86	22.30											

GratEX® Mini Mesh Specification

General

1.0 Scope

1.1 The grating shall conform to the material and fabrication requirements as per this specification.

2.0 Standards/Related documents

- 2.1 The grating system shall conform to the applicable sections of:
- 2.1.1 ASTM E84 Surface Burning Characteristics of Building Materials
 - 2.1.2 ASTM D635 Rate of Burning and/or Extent and Time of Burning of Self-Supporting Plastics in a Horizontal Position.

3.0 Design Criteria

- 3.1 The design criteria of the fibreglass products (FRP) shall be in accordance with governing building codes and generally accepted standards in the FRP industry.
- 3.2 Design live loads shall be of ... kPa uniformly distributed load (or as per building code if more stringent) with a maximum deflection of ... mm at the centre of a single span according to product specifications.

4.0 Submittals

- 4.1 Shop drawings of all fabricated grating panels shall be submitted by Treadwell (unless provided by the client) displaying clearly material sizes, types, styles, product codes and including types and sizes of fasteners as well as a layout if required.
- 4.2 Technical data and sample pieces can also be submitted if required.

5.0 Quality Assurance

Quality surrounds every aspect of Treadwell's commitment to our superior products and efficiency. Treadwell's quality assurance strictly adheres to the high quality control standards placed to conform to relevant specifications, codes, Australian Standards and contractual requirements in a timely manner.

6.0 Product Delivery and Storage

- 6.1 All grating and components or ancillary items shall be fabricated as per the design and piece marked to design drawings.
- 6.2 All manufactured materials shall be delivered in unbroken packages.

Product System

7.0 Manufacturing Process

- 7.1 All fibreglass (FRP) items listed under this section shall be constructed from fibreglass reinforcement and resin of the quality necessary to meet the design requirements and dimensions as specified.
- 7.2 Fibreglass reinforcement shall be continuous roving and shall be in sufficient quantities as required for the application.
- 7.3 Resins shall be ... (refer to page 5) with chemical formulations as necessary to provide the corrosion resistance, strength and any other physical properties as required.
- 7.4 All finished surfaces to be smooth, resin-rich, free of voids and without dry spots, cracks or unreinforced areas and all fibreglass reinforcement shall be well covered with resin to protect against exposure due to weather or wear.
- 7.5 All fibreglass (FRP) items shall be EITHER non-fire retardant OR have a tested flame spread rating of 25 or less when tested in accordance with the ASTM E84 Tunnel Test.
- 7.6 Contact Treadwell regarding specification data relative to products conforming to ASTM D635.

- 7.7 All metal accessories shall be manufactured from (304 or 316) Stainless Steel, 2205 Duplex Stainless Steel, 2507 Super Duplex Stainless Steel, hot dipped galvanised steel or aluminium.
- 7.8 Load bars shall be joined with notched cross bars via interlocking methods and the use of chemical bonding.
- 7.9 The fibreglass reinforcement content shall be maintained at 65% (by weight) so as to achieve maximum loading capacity.
- 7.10 All fibreglass material shall have an ultraviolet light inhibiting chemical additive to resist UV degradation.
- 7.11 Grating shall be manufactured with a concave profile on top of each bar OR an anti-slip Aluminium Oxide surface to provide optimum slip resistance.

8.0 Acceptable Manufacturer

The fibreglass underfoot moulded grating system shall be manufactured by Treadwell Group Pty Ltd of Australia.

Ordering Information

Code

- | | |
|--|-------------------------------|
| 1. Nominate the type of grating required | GTX = GratEX® Moulded Grating |
|--|-------------------------------|

Note: This section of the coding is typically separated from the next section of the coding by a dash (-)

- | | |
|---|--|
| 2. Nominate the depth (mm) required | 14, 22, 25, 30, 38 and 50 |
| 3. Nominate the load bar centres required | 1919 = 19mm x 19mm
2020 = 20mm x 20mm
2525 = 25mm x 25mm |
| 4. Nominate the mesh type required | M1 = Mini Mesh |

Note: This section of the coding is typically separated from the next section of the coding by a dash (-)

- | | |
|--|---|
| 5. Specify the resin, material or type (see page 6) | O = O-Series®
I = I-Series®
V = V-Series®
P = P-Series® |
| 6. Specify the colour required
<small>*In which instance a code and name of the selected colour must be mentioned within the description.</small> | TY = Treadwell Yellow
DG = Dark Grey
LG = Light Grey
TG = Treadwell Green
CH = Charcoal
CC = Custom Colour |
| 7. Specify the surface style required | G1 = Barefoot Grade (Grit) Anti-Slip
G2 = Commercial Grade (Grit) Anti-Slip
G3 = Industrial Grade (Grit) Anti-Slip
G4 = Marine Grade (Grit) Anti-Slip
CO = Concave
PL = Plain (Smooth) |







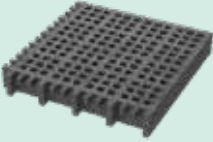
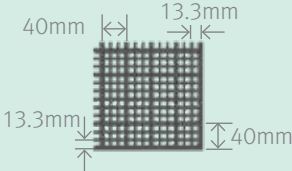
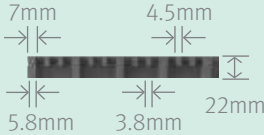

Note: The next section of coding is separated by a dash (-), it isn't required for custom jobs as GratEX® is available in a variety of size panels to suit applications.

- | | |
|-------------------------------------|--|
| 8. Nominate the panel size required | 01 = 1225mm x 3665mm
05 = 1247mm x 4047mm
06 = 1247mm x 3647mm
07 = 1247mm x 2407mm
08 = 1247mm x 2627mm
09 = 1247mm x 3687mm
11 = 1527mm x 3007mm
12 = 1247mm x 3007mm
13 = 1247mm x 1807mm
14 = 1247mm x 2007mm |
|-------------------------------------|--|

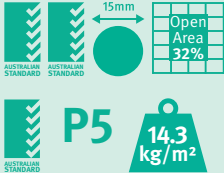
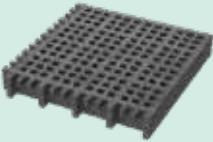
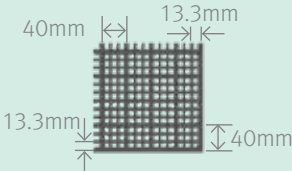
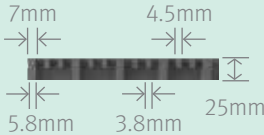
Please refer to Appendix 3: GratEX® Ordering Codes - page 82

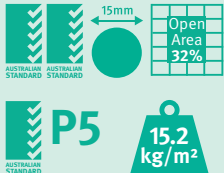
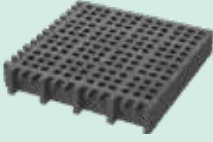
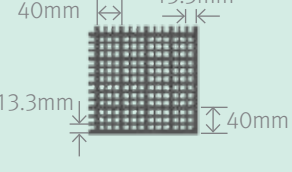
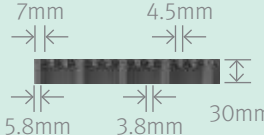
N Non-Stocked Item **C** Commonly Stocked Item

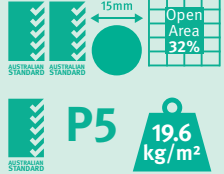
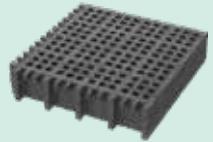
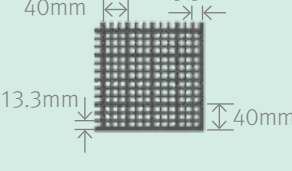
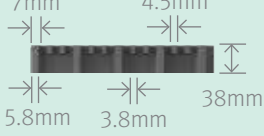
GratEX® Micro Mesh

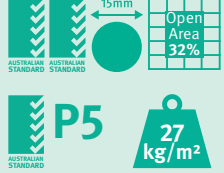
GTX-221313M2 N			
<p>Isometric View</p> 	<p>Plan View</p> 	<p>Elevation View</p> 	 
GTX-251313M2 N			
<p>Isometric View</p> 	<p>Plan View</p> 	<p>Elevation View</p> 	 
GTX-301313M2 C			
<p>Isometric View</p> 	<p>Plan View</p> 	<p>Elevation View</p> 	 
GTX-381313M2 C			
<p>Isometric View</p> 	<p>Plan View</p> 	<p>Elevation View</p> 	 

Benefits of FRP



Long Term Cost Benefits

Long service life, minimal maintenance costs and low installation costs all combine to provide a very competitive solution over time.



Non-Conductive & RF Transmission Transparent

FRP is transparent to radio frequency transmission and is non-conductive in nature. This makes the material ideal for applications that need to avoid electrical currents and radio frequency.

Safe Load & Deflection Charts (mm) - Uniform and Concentrated Line Loads

Mesh Grid	Load Bar Details	Span (mm)	Load Type	Uniform load – ΔU (kN/m ²) – Deflection (mm) Concentrated line load – ΔC (kN/m) – Deflection (mm)													
				3	5	8	10	15	20	25	30	40	50	60	80	90	100

GTX-221313M2																		
40x40/ 13x13	22x7/ 8x4	200	ΔU	0.05	0.09	0.14	0.17	0.26	0.35	0.43	0.52	0.69	0.87	1.04	1.39	1.56	1.73	
			ΔC	0.34	0.56	0.90	1.13	1.69	2.25	2.82	3.38	4.51	5.63	6.76	9.01	10.14	11.27	
		400	ΔU	0.48	0.89	1.37	1.81	2.70	3.62	4.51	5.44	7.21	9.06	10.83				
			ΔC	2.50	4.23	6.73	8.54											
		600	ΔU	2.21	3.79	6.00	7.57	11.36										
			ΔC	6.20	10.43													
		800	ΔU	6.81	10.43													
			ΔC	13.21														

GTX-251313M2																		
40x40/ 13x13	25x7/ 8x4	200	ΔU	0.04	0.06	0.09	0.12	0.18	0.24	0.30	0.35	0.47	0.59	0.71	0.95	1.06	1.18	
			ΔC	0.23	0.38	0.62	0.77	1.15	1.54	1.92	2.31	3.08	3.85	4.62	6.16	6.92	7.69	
		400	ΔU	0.33	0.61	0.94	1.24	1.84	2.48	3.08	3.71	4.92	6.19	7.40	9.90	11.11	12.32	
			ΔC	1.71	2.89	4.59	5.83	8.72	11.63									
		600	ΔU	1.51	2.59	4.10	5.17	7.76	10.37									
			ΔC	4.24	7.12	11.36												
		800	ΔU	4.65	7.12	12.46												
			ΔC	9.02														

GTX-301313M2																		
40x40/ 13x13	30x7/ 8x4	400	ΔU	0.19	0.35	0.55	0.72	1.07	1.44	1.80	2.16	2.87	3.61	4.31	5.77	6.48	7.18	
			ΔC	0.99	1.68	2.68	3.40	5.08	6.78	8.48	10.18	13.57						
		600	ΔU	0.88	1.51	2.39	3.01	4.52	6.05	7.54	9.06	12.24	15.10					
			ΔC	2.47	4.15	6.62	8.31	13.66										
		800	ΔU	2.71	4.15	7.26	9.11	13.66										
			ΔC	5.26	8.80	14.06												
		1000	ΔU	6.67	11.14													
			ΔC	10.87														

GTX-381313M2																		
40x40/ 13x13	38x7/ 8x4	400	ΔU	0.10	0.18	0.27	0.36	0.54	0.72	0.90	1.08	1.44	1.81	2.16	2.89	3.24	3.60	
			ΔC	0.50	0.84	1.34	1.70	2.55	3.40	4.25	5.10	6.79	8.50	10.19	13.60	15.29	16.94	
		600	ΔU	0.44	0.75	1.20	1.51	2.26	3.03	3.77	4.54	6.13	7.57	9.07	12.10	13.61	15.11	
			ΔC	1.24	2.08	3.32	4.16	6.84	8.33	10.40	12.49	16.82	21.03					
		800	ΔU	1.36	2.08	3.64	4.56	6.84	9.13	11.41	13.69	18.03						
			ΔC	2.63	4.41	7.04	8.82	13.21	17.61									
		1000	ΔU	3.34	5.58	8.92	11.18	16.74										
			ΔC	5.45	9.09	14.54												
		1200	ΔU	7.04	11.74	18.78												
			ΔC	9.30	15.52													

GratEX® Micro Mesh Specification

General

1.0 Scope

1.1 The grating shall conform to the material and fabrication requirements as per this specification.

2.0 Standards/Related documents

- 2.1 The grating system shall conform to the applicable sections of:
- 2.1.1 ASTM E84 Surface Burning Characteristics of Building Materials
 - 2.1.2 ASTM D635 Rate of Burning and/or Extent and Time of Burning of Self-Supporting Plastics in a Horizontal Position.

3.0 Design Criteria

- 3.1 The design criteria of the fibreglass products (FRP) shall be in accordance with governing building codes and generally accepted standards in the FRP industry.
- 3.2 Design live loads shall be of ... kPa uniformly distributed load (or as per building code if more stringent) with a maximum deflection of ... mm at the centre of a single span according to product specifications.

4.0 Submittals

- 4.1 Shop drawings of all fabricated grating panels shall be submitted by Treadwell (unless provided by the client) displaying clearly material sizes, types, styles, product codes and including types and sizes of fasteners as well as a layout if required.
- 4.2 Technical data and sample pieces can also be submitted if required.

5.0 Quality Assurance

Quality surrounds every aspect of Treadwell's commitment to our superior products and efficiency. Treadwell's quality assurance strictly adheres to the high quality control standards placed to conform to relevant specifications, codes, Australian Standards and contractual requirements in a timely manner.

6.0 Product Delivery and Storage

- 6.1 All grating and components or ancillary items shall be fabricated as per the design and piece marked to design drawings.
- 6.2 All manufactured materials shall be delivered in unbroken packages.

Product System

7.0 Manufacturing Process

- 7.1 All fibreglass (FRP) items listed under this section shall be constructed from fibreglass reinforcement and resin of the quality necessary to meet the design requirements and dimensions as specified.
- 7.2 Fibreglass reinforcement shall be continuous roving and shall be in sufficient quantities as required for the application.
- 7.3 Resins shall be ... (refer to page 5) with chemical formulations as necessary to provide the corrosion resistance, strength and any other physical properties as required.
- 7.4 All finished surfaces to be smooth, resin-rich, free of voids and without dry spots, cracks or unreinforced areas and all fibreglass reinforcement shall be well covered with resin to protect against exposure due to weather or wear.
- 7.5 All fibreglass (FRP) items shall be EITHER non-fire retardant OR have a tested flame spread rating of 25 or less when tested in accordance with the ASTM E84 Tunnel Test.
- 7.6 Contact Treadwell regarding specification data relative to products conforming to ASTM D635.

- 7.7 All metal accessories shall be manufactured from (304 or 316) Stainless Steel, 2205 Duplex Stainless Steel, 2507 Super Duplex Stainless Steel, hot dipped galvanised steel or aluminium.
- 7.8 Load bars shall be joined with notched cross bars via interlocking methods and the use of chemical bonding.
- 7.9 The fibreglass reinforcement content shall be maintained at 65% (by weight) so as to achieve maximum loading capacity.
- 7.10 All fibreglass material shall have an ultraviolet light inhibiting chemical additive to resist UV degradation.
- 7.11 Grating shall be manufactured with a concave profile on top of each bar OR an anti-slip Aluminium Oxide surface to provide optimum slip resistance.

8.0 Acceptable Manufacturer

The fibreglass underfoot moulded grating system shall be manufactured by Treadwell Group Pty Ltd of Australia.

Ordering Information

Code

- | | |
|--|-------------------------------|
| 1. Nominate the type of grating required | GTx = GratEX® Moulded Grating |
|--|-------------------------------|

Note: This section of the coding is typically separated from the next section of the coding by a dash (-)

- | | |
|---|--------------------|
| 2. Nominate the depth (mm) required | 22, 25, 30 and 38 |
| 3. Nominate the load bar centres required | 1313 = 13mm x 13mm |
| 4. Nominate the mesh type required | M2 = Micro Mesh |

Note: This section of the coding is typically separated from the next section of the coding by a dash (-)

- | | |
|---|---|
| 5. Specify the resin, material or type (see page 6) | O = O-Series®
I = I-Series®
V = V-Series®
P = P-Series® |
| 6. Specify the colour required | TY = Treadwell Yellow
DG = Dark Grey
LG = Light Grey
TG = Treadwell Green
CH = Charcoal
CC = Custom Colour |

*In which instance a code and name of the selected colour must be mentioned within the description.

- | | |
|---------------------------------------|---|
| 7. Specify the surface style required | G1 = Barefoot Grade (Grit) Anti-Slip
G2 = Commercial Grade (Grit) Anti-Slip
G3 = Industrial Grade (Grit) Anti-Slip
G4 = Marine Grade (Grit) Anti-Slip
CO = Concave
PL = Plain (Smooth) |
|---------------------------------------|---|

Note: The next section of coding is separated by a dash (-), it isn't required for custom jobs as GratEX® is available in a variety of size panels to suit applications.



- | | |
|-------------------------------------|--|
| 8. Nominate the panel size required | 05 = 1247mm x 4047mm
09 = 1247mm x 3687mm |
|-------------------------------------|--|

Please refer to Appendix 3: GratEX® Ordering Codes - page 82

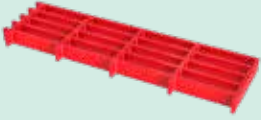
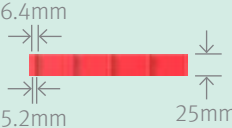

N Non-Stocked Item **C** Commonly Stocked Item

GratEX® Rectangular Mesh

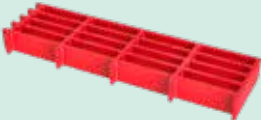
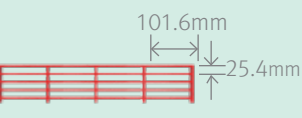

GTX-251025SR N

<p>Isometric View</p> 	<p>Plan View</p> 	<p>Elevation View</p> 	
---	--	--	---

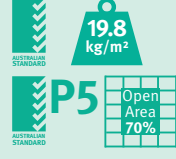

GTX-381025SR N

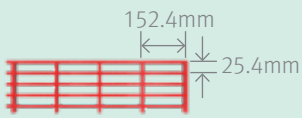
<p>Isometric View</p> 	<p>Plan View</p> 	<p>Elevation View</p> 	
---	--	--	---

GTX-381525SR N

<p>Isometric View</p> 	<p>Plan View</p> 	<p>Elevation View</p> 	
--	---	---	--

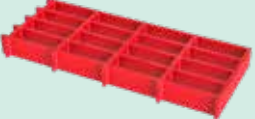
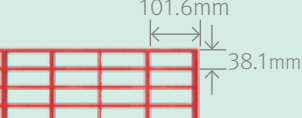
GTX-381038SR N

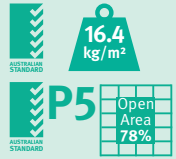
<p>Isometric View</p> 	<p>Plan View</p> 	<p>Elevation View</p> 	
---	--	--	---

Safe Load & Deflection Charts (mm) - Uniform and Concentrated Line Loads

Mesh Grid	Load Bar Details	Span (mm)	Load Type	Uniform load – ΔU (kN/m²) – Deflection (mm) Concentrated line load – ΔC (kN/m) – Deflection (mm)															
				3	5	8	10	15	20	25	30	40	50	60	80	90	100		

GTX-251025SR																		
101X25	25/6X5	200	ΔU	0.02	0.04	0.06	0.08	0.12	0.16	0.20	0.23	0.31	0.39	0.47	0.63	0.70	0.78	
			ΔC	0.51	0.86	1.37	1.71	2.57	3.42	4.28	5.14	6.85	8.56	10.27	13.69	15.41		
		400	ΔU	0.30	0.50	0.79	0.99	1.49	1.99	2.48	2.98	3.97	4.97	5.96	7.95	8.94	9.93	
			ΔC	1.72	2.86	4.58	5.72	8.59	11.45	14.31								
		600	ΔU	1.44	2.39	3.83	4.79	7.18	9.57	11.96								
			ΔC	4.30	7.17	11.47	14.34											
		800	ΔU	4.46	7.43	11.89	14.86											
			ΔC	8.96	14.93													
		1000	ΔU	10.79														
			ΔC	16.38														

GTX-381025SR																		
101X25	38/6X5	200	ΔU	0.01	0.01	0.02	0.02	0.03	0.05	0.06	0.07	0.09	0.11	0.14	0.18	0.20	0.23	
			ΔC	0.15	0.25	0.40	0.50	0.75	0.99	1.24	1.49	1.99	2.49	2.98	3.98	4.48	4.97	
		400	ΔU	0.09	0.14	0.23	0.29	0.43	0.58	0.72	0.87	1.15	1.44	1.73	2.31	2.60	2.89	
			ΔC	0.50	0.83	1.33	1.66	2.50	3.33	4.16	4.99	6.65	8.32	9.98	13.31	14.97	16.63	
		600	ΔU	0.42	0.70	1.11	1.39	2.09	2.78	3.48	4.17	5.56	6.95	8.34	11.12	12.52	13.91	
			ΔC	1.25	2.08	3.33	4.17	6.25	8.33	10.42	12.50	16.67						
		800	ΔU	1.30	2.16	3.45	4.32	6.48	8.63	10.79	12.95							
			ΔC	2.60	4.34	6.94	8.68	13.01										
		1000	ΔU	3.14	5.23	8.36	10.45	15.68										
			ΔC	4.76	7.93	12.69	15.86											
		1200	ΔU	6.47	10.79													
			ΔC	7.92	13.19													

GratEX® Rectangular Mesh Specification

General

1.0 Scope

1.1 The grating shall conform to the material and fabrication requirements as per this specification.

2.0 Standards/Related documents

- 2.1 The grating system shall conform to the applicable sections of:
- 2.1.1 ASTM E84 Surface Burning Characteristics of Building Materials
 - 2.1.2 ASTM D635 Rate of Burning and/or Extent and Time of Burning of Self-Supporting Plastics in a Horizontal Position.

3.0 Design Criteria

- 3.1 The design criteria of the fibreglass products (FRP) shall be in accordance with governing building codes and generally accepted standards in the FRP industry.
- 3.2 Design live loads shall be of ... kPa uniformly distributed load (or as per building code if more stringent) with a maximum deflection of ... mm at the centre of a single span according to product specifications.

4.0 Submittals

- 4.1 Shop drawings of all fabricated grating panels shall be submitted by Treadwell (unless provided by the client) displaying clearly material sizes, types, styles, product codes and including types and sizes of fasteners as well as a layout if required.
- 4.2 Technical data and sample pieces can also be submitted if required.

5.0 Quality Assurance

Quality surrounds every aspect of Treadwell's commitment to our superior products and efficiency. Treadwell's quality assurance strictly adheres to the high quality control standards placed to conform to relevant specifications, codes, Australian Standards and contractual requirements in a timely manner.

6.0 Product Delivery and Storage

- 6.1 All grating and components or ancillary items shall be fabricated as per the design and piece marked to design drawings.
- 6.2 All manufactured materials shall be delivered in unbroken packages.

Product System

7.0 Manufacturing Process

- 7.1 All fibreglass (FRP) items listed under this section shall be constructed from fibreglass reinforcement and resin of the quality necessary to meet the design requirements and dimensions as specified.
- 7.2 Fibreglass reinforcement shall be continuous roving and shall be in sufficient quantities as required for the application.
- 7.3 Resins shall be ... (refer to page 5) with chemical formulations as necessary to provide the corrosion resistance, strength and any other physical properties as required.
- 7.4 All finished surfaces to be smooth, resin-rich, free of voids and without dry spots, cracks or unreinforced areas and all fibreglass reinforcement shall be well covered with resin to protect against exposure due to weather or wear.
- 7.5 All fibreglass (FRP) items shall be EITHER non-fire retardant OR have a tested flame spread rating of 25 or less when tested in accordance with the ASTM E84 Tunnel Test.
- 7.6 Contact Treadwell regarding specification data relative to products conforming to ASTM D635.

- 7.7 All metal accessories shall be manufactured from (304 or 316) Stainless Steel, 2205 Duplex Stainless Steel, 2507 Super Duplex Stainless Steel, hot dipped galvanised steel or aluminium.
- 7.8 Load bars shall be joined with notched cross bars via interlocking methods and the use of chemical bonding.
- 7.9 The fibreglass reinforcement content shall be maintained at 65% (by weight) so as to achieve maximum loading capacity.
- 7.10 All fibreglass material shall have an ultraviolet light inhibiting chemical additive to resist UV degradation.
- 7.11 Grating shall be manufactured with a concave profile on top of each bar OR an anti-slip Aluminium Oxide surface to provide optimum slip resistance.

8.0 Acceptable Manufacturer

The fibreglass underfoot moulded grating system shall be manufactured by Treadwell Group Pty Ltd of Australia.

Ordering Information

Code

- | | |
|--|--------------------------------------|
| 1. Nominate the type of grating required | GTx = GratEX® Moulded Grating |
|--|--------------------------------------|

Note: This section of the coding is typically separated from the next section of the coding by a dash (-)

- | | |
|---|--|
| 2. Nominate the depth (mm) required | 25 and 38 |
| 3. Nominate the load bar centres required | 1025 = 100mm x 25mm
1038 = 100mm x 38mm
1525 = 152mm x 25mm |
| 4. Nominate the mesh type required | SR = Standard Rectangular Mesh |

Note: This section of the coding is typically separated from the next section of the coding by a dash (-)

- | | |
|--|---|
| 5. Specify the resin, material or type (see page 6) | O = O-Series®
I = I-Series®
V = V-Series®
P = P-Series® |
| 6. Specify the colour required
<small>*In which instance a code and name of the selected colour must be mentioned within the description.</small> | TY = Treadwell Yellow
DG = Dark Grey
LG = Light Grey
TG = Treadwell Green
CH = Charcoal
CC = Custom Colour |
| 7. Specify the surface style required | G1 = Barefoot Grade (Grit) Anti-Slip
G2 = Commercial Grade (Grit) Anti-Slip
G3 = Industrial Grade (Grit) Anti-Slip
G4 = Marine Grade (Grit) Anti-Slip
CO = Concave
PL = Plain (Smooth) |

Note: The next section of coding is separated by a dash (-), it isn't required for custom jobs as GratEX® is available in a variety of size panels to suit applications.

- | | |
|-------------------------------------|-----------------------------|
| 8. Nominate the panel size required | 01 = 1225mm X 3665mm |
|-------------------------------------|-----------------------------|



Please refer to Appendix 3: GratEX® Ordering Codes - page 89

N Non-Stocked Item **C** Commonly Stocked Item

GratEX® Heavy Duty Rectangular Mesh

GTX-251025HR

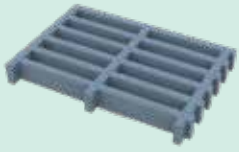
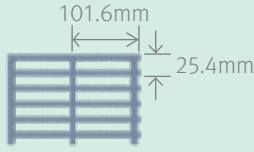
N

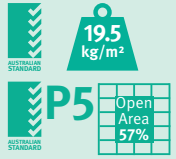
<p>Isometric View</p> 	<p>Plan View</p> 	<p>Elevation View</p> 	
---	--	--	---

GTX-385025HR

N

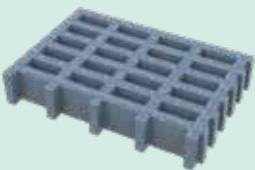
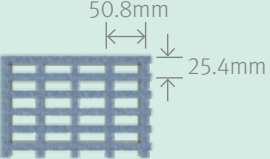
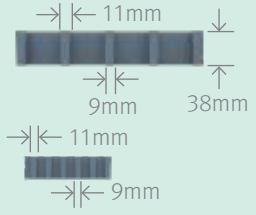
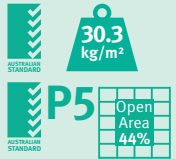
<p>Isometric View</p> 	<p>Plan View</p> 	<p>Elevation View</p> 	
---	--	--	---

GTX-505025HR

N

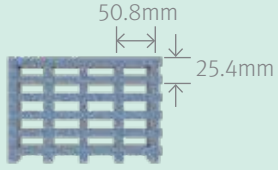
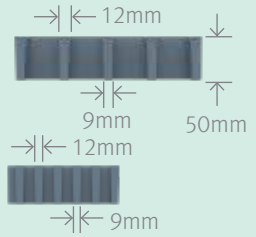
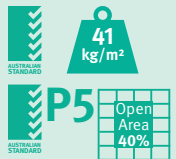
<p>Isometric View</p> 	<p>Plan View</p> 	<p>Elevation View</p> 	
---	--	--	---

Mesh Grid	Load Bar Details	Span (mm)	Load Type	Uniform load – ΔU (kN/m²) – Deflection (mm) Concentrated line load – ΔC (kN/m) – Deflection (mm)													
				3	5	8	10	15	20	25	30	40	50	60	80	90	100
GTX-505025HR																	
50X25	38/11X9	200	ΔU	0.01	0.01	0.02	0.03	0.04	0.06	0.07	0.09	0.11	0.14	0.17	0.23	0.26	0.29
			ΔC	0.06	0.09	0.15	0.19	0.28	0.38	0.47	0.57	0.76	0.95	1.14	1.52	1.71	1.90
		400	ΔU	0.04	0.07	0.12	0.15	0.22	0.29	0.36	0.44	0.58	0.73	0.87	1.16	1.31	1.45
			ΔC	0.17	0.29	0.46	0.58	0.87	1.15	1.44	1.73	2.31	2.88	3.46	4.62	5.19	5.77
		600	ΔU	0.13	0.22	0.35	0.44	0.66	0.89	1.11	1.33	1.77	2.21	2.66	3.54	3.98	4.43
			ΔC	0.41	0.68	1.09	1.36	2.04	2.72	3.40	4.07	5.43	6.79	8.15	10.87	12.22	13.58
		800	ΔU	0.32	0.54	0.86	1.08	1.61	2.15	2.69	3.23	4.30	5.38	6.45	8.60	9.68	10.76
			ΔC	0.82	1.37	2.18	2.73	4.10	5.46	6.83	8.19	10.92	13.65	16.38	21.85	24.58	
		1000	ΔU	0.68	1.13	1.81	2.26	3.39	4.52	5.65	6.78	9.04	11.30	13.56	18.08	20.34	22.60
			ΔC	1.47	2.45	3.91	4.89	7.34	9.78	12.23	14.68	19.57	24.46				
		1200	ΔU	1.28	2.14	3.42	4.28	6.41	8.55	10.69	12.83	17.10	21.38	25.65			
			ΔC	2.41	4.02	6.43	8.04	12.06	16.08	20.10	24.12						
		1400	ΔU	2.24	3.73	5.97	7.46	11.19	14.92	18.65	22.38						
			ΔC	3.71	6.18	9.89	12.37	18.55	24.74								
		1600	ΔU	3.67	6.11	9.77	12.22	18.33	24.44								
			ΔC	5.42	9.04	14.46	18.08										

GratEX® Heavy Duty Rectangular Mesh

Load Case	Description	Load Distributed Area	Concentrated Load in SLS (kN)
A	AS1170.1 - Light Vehicle traffic not exceeding 2,500kg	100mm x 100mm	13
B	AS5100.2 - Light vehicle load not exceeding 4500kg / AS4997 - Class 5 Pedestrian crowd load light motor vehicles up to 3000kg	200mm x 200mm	20
C	AS1170.1 - Medium Vehicle traffic between 2,500kg and 10,000kg	100mm x 100mm	31
D	AS4997 - Class 10 Small emergency vehicle	300mm x 150mm	45
E	AS3996 - Class B Residential car parks	240mm x 240mm	53
F	AS5100.2 - W8o Wheel load	400mm x 250mm	80

Span	Grating Type	Load Case					
		A	B	C	D	E	F
300	GTX-503838HS	0.50	0.77	1.19	1.73	2.04	
	GTX-603838HS	0.31	0.47	0.73	1.07	1.25	1.89
	GTX-385025HR	0.64	0.99	1.54	2.23	2.63	
	GTX-505025HR	0.34	0.53	0.82	1.19	1.40	2.11
450	GTX-503838HS	1.26	1.93	3.00	4.35		
	GTX-603838HS	0.73	1.12	1.74	2.52	2.97	4.48
	GTX-385025HR	1.94	2.98				
	GTX-505025HR	0.93	1.43	2.22	3.22	3.79	
600	GTX-503838HS	2.56	3.94				
	GTX-603838HS	1.40	2.15	3.34	4.84	5.71	
	GTX-385025HR	4.27					
	GTX-505025HR	1.82	2.8	4.34			

Important Notes:

1. Maximum loads shown are for deflections of the lesser of Span/Deflection = 100 and a Factor of Safety of 3 in ULS
2. Deflection values are based on the use of a 1220mm wide grating and the given span, where the concentrated load is applied at the centre of the grating.
3. Deflection values are based on the grating supported in two edges. If the concentrated load is applied at different location or three/four edges supported, please contact Treadwell engineering team for further assistance.

GratEX® Heavy Duty Rectangular Mesh Specification

General

1.0 Scope

1.1 The grating shall conform to the material and fabrication requirements as per this specification.

2.0 Standards/Related documents

2.1 The grating system shall conform to the applicable sections of:

2.1.1 ASTM E84 Surface Burning Characteristics of Building Materials

2.1.2 ASTM D635 Rate of Burning and/or Extent and Time of Burning of Self-Supporting Plastics in a Horizontal Position.

3.0 Design Criteria

3.1 The design criteria of the fibreglass products (FRP) shall be in accordance with governing building codes and generally accepted standards in the FRP industry.

3.2 Design live loads shall be of ... kPa uniformly distributed load (or as per building code if more stringent) with a maximum deflection of ... mm at the centre of a single span according to product specifications.

4.0 Submittals

4.1 Shop drawings of all fabricated grating panels shall be submitted by Treadwell (unless provided by the client) displaying clearly material sizes, types, styles, product codes and including types and sizes of fasteners as well as a layout if required.

4.2 Technical data and sample pieces can also be submitted if required.

5.0 Quality Assurance

Quality surrounds every aspect of Treadwell's commitment to our superior products and efficiency. Treadwell's quality assurance strictly adheres to the high quality control standards placed to conform to relevant specifications, codes, Australian Standards and contractual requirements in a timely manner.

6.0 Product Delivery and Storage

6.1 All grating and components or ancillary items shall be fabricated as per the design and piece marked to design drawings.

6.2 All manufactured materials shall be delivered in unbroken packages.

Product System

7.0 Manufacturing Process

7.1 All fibreglass (FRP) items listed under this section shall be constructed from fibreglass reinforcement and resin of the quality necessary to meet the design requirements and dimensions as specified.

7.2 Fibreglass reinforcement shall be continuous roving and shall be in sufficient quantities as required for the application.

7.3 Resins shall be ... (refer to page 5) with chemical formulations as necessary to provide the corrosion resistance, strength and any other physical properties as required.

7.4 All finished surfaces to be smooth, resin-rich, free of voids and without dry spots, cracks or unreinforced areas and all fibreglass reinforcement shall be well covered with resin to protect against exposure due to weather or wear.

7.5 All fibreglass (FRP) items shall be EITHER non-fire retardant OR have a tested flame spread rating of 25 or less when tested in accordance with the ASTM E84 Tunnel Test.

7.6 Contact Treadwell regarding specification data relative to products conforming to ASTM D635.

7.7 All metal accessories shall be manufactured from (304 or 316) Stainless Steel, 2205 Duplex Stainless Steel, 2507 Super Duplex Stainless Steel, hot dipped galvanised steel or aluminium.

7.8 Load bars shall be joined with notched cross bars via interlocking methods and the use of chemical bonding.

7.9 The fibreglass reinforcement content shall be maintained at 65% (by weight) so as to achieve maximum loading capacity.

7.10 All fibreglass material shall have an ultraviolet light inhibiting chemical additive to resist UV degradation.

7.11 Grating shall be manufactured with a concave profile on top of each bar OR an anti-slip Aluminium Oxide surface to provide optimum slip resistance.

8.0 Acceptable Manufacturer

The fibreglass underfoot moulded grating system shall be manufactured by Treadwell Group Pty Ltd of Australia.

Ordering Information

Code

1. Nominate the type of grating required **GTX = GratEX® Moulded Grating**

Note: This section of the coding is typically separated from the next section of the coding by a dash (-)

2. Nominate the depth (mm) required **25, 38, and 50**

3. Nominate the load bar centres required **1025 = 100mm x 25mm**
5025 = 50mm x 25mm

4. Nominate the mesh type required **HR = Heavy Duty Rectangular Mesh**

Note: This section of the coding is typically separated from the next section of the coding by a dash (-)

5. Specify the resin, material or type (see page 6) **O = O-Series®**
I = I-Series®
V = V-Series®
P = P-Series®

6. Specify the colour required **TY = Treadwell Yellow**
DG = Dark Grey
LG = Light Grey
TG = Treadwell Green
CH = Charcoal
CC = Custom Colour

7. Specify the surface style required **G1 = Barefoot Grade (Grit)**
Anti-Slip
G2 = Commercial Grade (Grit)
Anti-Slip
G3 = Industrial Grade (Grit)
Anti-Slip
G4 = Marine Grade (Grit)
Anti-Slip
CO = Concave
PL = Plain (Smooth)

Note: The next section of coding is separated by a dash (-), it isn't required for custom jobs as GratEX® is available in a variety of size panels to suit applications.

8. Nominate the panel size required **O1 = 1225mm x 3665mm**

Please refer to Appendix 3: GratEX® Ordering Codes - page 82

N Non-Stocked Item **C** Commonly Stocked Item

GratEX® Solid Surface Mesh

GratEX® Solid Surface Options

Anti-Slip Surface (Standard). This surface is most commonly used in industrial applications. It is very hard-wearing and has an extremely effective coefficient of friction (NATA laboratory test report available). Unlike serrated steel grating, the anti-slip surface does not impact on load carrying capacity.

Chequer Plate Surface. Offers a less aggressive anti-slip flooring solution which does not trap as much dirt or grime as grit types and can be cleaned much easier. These options also offer superior aesthetics compared to other surface finishes.

Diamond Plate. Diamond Plate surface is a popular cover option that offers less traction. It is ideal in environments where grit and grime can be potentially trapped in conventional grating. The diamond pattern is aesthetically pleasing and easy to clean.

Plain Surface. This surface is a non-stock option and is most commonly utilised in applications where a robust and anti-corrosive substrate is required for a primary floor covering. Used commonly in commercial and industrial flooring applications, it successfully provides lightweight and cost-effective solutions.



GTX-203838F3, GTX-203838F5 N

<p>Isometric View</p>	<p>Plan View</p>	<p>Elevation View</p>	<p>12.6 kg/m²**</p>
-----------------------	------------------	-----------------------	--------------------------------

GTX-237979F3, GTX-237979F5 N

<p>Isometric View</p>	<p>Plan View</p>	<p>Elevation View</p>	<p>8.5 kg/m²**</p>
-----------------------	------------------	-----------------------	-------------------------------

Benefits of FRP



No Protective Coating Required

Treadwell's unique surface finishing system ensures UV stability in exposed applications, directly eliminating the need for costly surface treatment.



Corrosion, Rust & Rot Proof

Treadwell's superior resin systems offer exceptional resistance to acids, salts and alkalis. At the same time, our FRP systems are rot and termite proof.

GratEX® Solid Surface Mesh

GTX-253838F3, GTX-253838F5

N

Isometric View

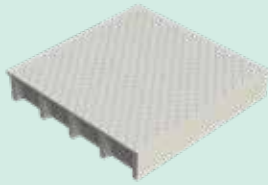

Plan View



Elevation View

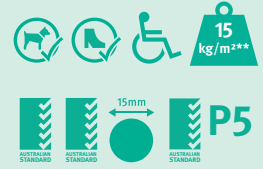
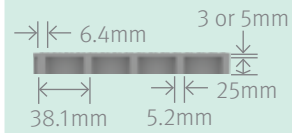

GTX-303838F3, GTX-303838F5

N

Isometric View

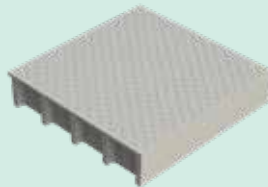

Plan View

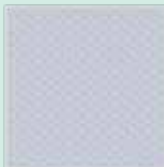

Elevation View

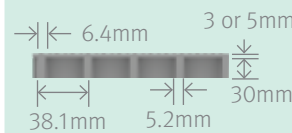

GTX-383838F3, GTX-383838F5

C

Isometric View

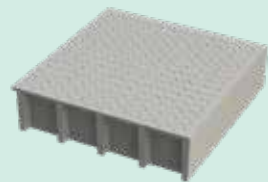

Plan View



Elevation View

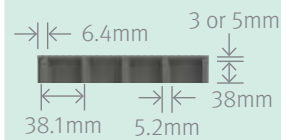

GTX-505050F3, GTX-505050F5

C

Isometric View

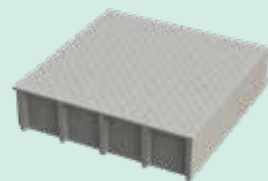

Plan View



Elevation View

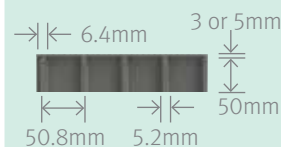

GratEX® Solid Surface Mesh

Safe Load & Deflection Charts (mm) - Uniform and Concentrated Line Loads

Mesh Grid	Load Bar Details	Span (mm)	Load Type	Uniform load – ΔU (kN/m ²) – Deflection (mm) Concentrated line load – ΔC (kN/m) – Deflection (mm)													
				3	5	8	10	15	20	25	30	40	50	60	80	90	100

GTX-253838F3, GTX-253838F5																		
38X38	25X6	200	ΔU	0.27	0.45	0.72	0.90	1.35	1.80	2.25	2.70	3.60	4.50	5.40	7.20	8.09	8.99	
			ΔC	0.56	0.94	1.50	1.87	2.81	3.74	4.68	5.61	7.49	9.36	11.23	14.97			
		400	ΔU	0.41	0.69	1.10	1.38	2.07	2.76	3.45	4.14	5.51	6.89	8.27	11.03	12.41		
			ΔC	1.59	2.65	4.24	5.30	7.95	10.59	13.24								
		600	ΔU	1.48	2.47	3.96	4.95	7.42	9.89	12.37								
			ΔC	4.30	7.17	11.48	14.35											
		800	ΔU	4.89	8.15	13.04												
			ΔC	9.93														

GTX-383838F3, GTX-383838F5																		
38X38	38X6	200	ΔU	0.08	0.13	0.20	0.26	0.38	0.51	0.64	0.77	1.02	1.28	1.54	2.05	2.31	2.56	
			ΔC	0.16	0.27	0.43	0.53	0.80	1.07	1.33	1.60	2.13	2.66	3.20	4.26	4.80	5.33	
		400	ΔU	0.12	0.20	0.31	0.39	0.59	0.79	0.98	1.18	1.57	1.96	2.36	3.14	3.53	3.93	
			ΔC	0.45	0.75	1.21	1.51	2.26	3.02	3.77	4.52	6.03	7.54	9.05	12.07	13.57	15.08	
		600	ΔU	0.42	0.70	1.13	1.41	2.11	2.82	3.52	4.23	5.63	7.04	8.45	11.27	12.68	14.09	
			ΔC	1.23	2.04	3.27	4.09	6.13	8.17	10.21	12.26	16.34						
		800	ΔU	1.39	2.32	3.71	4.64	6.96	9.28	11.60	13.92	18.56						
			ΔC	2.83	4.71	7.54	9.42	14.14	18.85									
		1000	ΔU	3.53	5.88	9.41	11.76	17.64										
			ΔC	5.61	9.34	14.95	18.68											
		1200	ΔU	7.43	12.38	19.81												
			ΔC	9.91	16.51													

GTX-505050F3, GTX-505050F5																		
50X50	50X6	200	ΔU	0.04	0.07	0.12	0.15	0.22	0.30	0.37	0.45	0.60	0.75	0.90	1.20	1.35	1.50	
			ΔC	0.09	0.16	0.25	0.31	0.47	0.62	0.78	0.94	1.25	1.56	1.87	2.50	2.81	3.12	
		400	ΔU	0.07	0.11	0.18	0.23	0.34	0.46	0.57	0.69	0.92	1.15	1.38	1.84	2.07	2.30	
			ΔC	0.26	0.44	0.71	0.88	1.32	1.77	2.21	2.65	3.53	4.41	5.30	7.06	7.95	8.83	
		600	ΔU	0.25	0.41	0.66	0.82	1.24	1.65	2.06	2.47	3.30	4.12	4.95	6.60	7.42	8.25	
			ΔC	0.72	1.20	1.91	2.39	3.59	4.78	5.98	7.17	9.57	11.96	14.35	19.13	21.52	23.91	
		800	ΔU	0.81	1.36	2.17	2.72	4.07	5.43	6.79	8.15	10.86	13.58	16.29	21.73	24.44		
			ΔC	3.28	5.47	8.75	10.94	16.40	21.87									
		1000	ΔU	2.06	3.44	5.51	6.88	10.32	13.76	17.20	20.64							
			ΔC	3.28	5.47	8.75	10.94	16.40	21.87									
		1200	ΔU	4.35	7.25	11.60	14.50	21.75										
			ΔC	5.80	9.66	15.46	19.33											

GratEX® Solid Surface Mesh Specification

General

1.0 Scope

1.1 The grating shall conform to the material and fabrication requirements as per this specification.

2.0 Standards/Related documents

- 2.1 The grating system shall conform to the applicable sections of:
 - 2.1.1 ASTM E84 Surface Burning Characteristics of Building Materials
 - 2.1.2 ASTM D635 Rate of Burning and/or Extent and Time of Burning of Self-Supporting Plastics in a Horizontal Position.

3.0 Design Criteria

- 3.1 The design criteria of the fibreglass products (FRP) shall be in accordance with governing building codes and generally accepted standards in the FRP industry.
- 3.2 Design live loads shall be of ... kPa uniformly distributed load (or as per building code if more stringent) with a maximum deflection of ... mm at the centre of a single span according to product specifications.

4.0 Submittals

- 4.1 Shop drawings of all fabricated grating panels shall be submitted by Treadwell (unless provided by the client) displaying clearly material sizes, types, styles, product codes and including types and sizes of fasteners as well as a layout if required.
- 4.2 Technical data and sample pieces can also be submitted if required.

5.0 Quality Assurance

Quality surrounds every aspect of Treadwell's commitment to our superior products and efficiency. Treadwell's quality assurance strictly adheres to the high quality control standards placed to conform to relevant specifications, codes, Australian Standards and contractual requirements in a timely manner.

6.0 Product Delivery and Storage

- 6.1 All grating and components or ancillary items shall be fabricated as per the design and piece marked to design drawings.
- 6.2 All manufactured materials shall be delivered in unbroken packages.

Product System

7.0 Manufacturing Process

- 7.1 All fibreglass (FRP) items listed under this section shall be constructed from fibreglass reinforcement and resin of the quality necessary to meet the design requirements and dimensions as specified.
- 7.2 Fibreglass reinforcement shall be continuous roving and shall be in sufficient quantities as required for the application.
- 7.3 Resins shall be ... (refer to page 5) with chemical formulations as necessary to provide the corrosion resistance, strength and any other physical properties as required.
- 7.4 All finished surfaces to be smooth, resin-rich, free of voids and without dry spots, cracks or unreinforced areas and all fibreglass reinforcement shall be well covered with resin to protect against exposure due to weather or wear.
- 7.5 All fibreglass (FRP) items shall be EITHER non-fire retardant OR have a tested flame spread rating of 25 or less when tested in accordance with the ASTM E84 Tunnel Test.
- 7.6 Contact Treadwell regarding specification data relative to products conforming to ASTM D635.

- 7.7 All metal accessories shall be manufactured from (304 or 316) Stainless Steel, 2205 Duplex Stainless Steel, 2507 Super Duplex Stainless Steel, hot dipped galvanised steel or aluminium.
- 7.8 Load bars shall be joined with notched cross bars via interlocking methods and the use of chemical bonding.
- 7.9 The fibreglass reinforcement content shall be maintained at 65% (by weight) so as to achieve maximum loading capacity.
- 7.10 All fibreglass material shall have an ultraviolet light inhibiting chemical additive to resist UV degradation.
- 7.11 Grating shall be manufactured with a concave profile on top of each bar OR an anti-slip Aluminium Oxide surface to provide optimum slip resistance.

8.0 Acceptable Manufacturer

The fibreglass underfoot moulded grating system shall be manufactured by Treadwell Group Pty Ltd of Australia.

Ordering Information	Code
1. Nominate the type of grating required	GTX = GratEX® Moulded Grating
Note: This section of the coding is typically separated from the next section of the coding by a dash (-)	
2. Nominate the depth (mm) required	20, 23, 25, 30, 38 and 50
3. Nominate the load bar centres required	3838 = 38mm x 38mm 5050 = 50mm x 50mm 7979 = 79mm x 79mm
4. Nominate the mesh type required	F3 = Solid Surface (3mm) Mesh F5 = Solid Surface (5mm) Mesh
Note: This section of the coding is typically separated from the next section of the coding by a dash (-)	
5. Specify the resin, material or type (see page 6)	O = O-Series® I = I-Series® V = V-Series® P = P-Series®
6. Specify the colour required <small>*In which instance a code and name of the selected colour must be mentioned within the description.</small>	TY = Treadwell Yellow DG = Dark Grey LG = Light Grey TG = Treadwell Green CH = Charcoal CC = Custom Colour
7. Specify the surface style required	G1 = Barefoot Grade (Grit) Anti-Slip G2 = Commercial Grade (Grit) Anti-Slip G3 = Industrial Grade (Grit) Anti-Slip G4 = Marine Grade (Grit) Anti-Slip CH = Chequer Plate DP = Diamond Plate PL = Plain (Smooth)
Note: The next section of coding is separated by a dash (-), it isn't required for custom jobs as GratEX® is available in a variety of size panels to suit applications.	
8. Nominate the panel size required	01 = 1225mm x 3665mm 02 = 920mm x 3055mm 03 = 610mm x 3665mm 04 = 1225mm x 4040mm





Please refer to Appendix 3: GratEX® Ordering Codes - page 82

N Non-Stocked Item **C** Commonly Stocked Item

GratEX® Heavy Duty Solid Surface Mesh

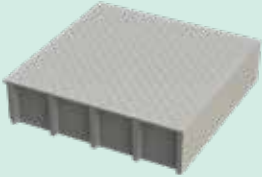

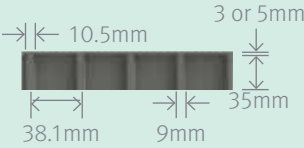
GTX-353838H3, GTX-353838H5

N

<p>Isometric View</p> 	<p>Plan View</p> 	<p>Elevation View</p> 	
---	--	--	---

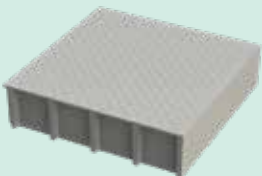

GTX-503838H3, GTX-503838H5

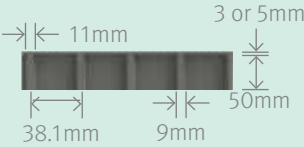
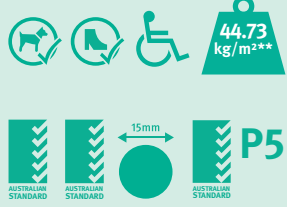
N

<p>Isometric View</p> 	<p>Plan View</p> 	<p>Elevation View</p> 	
---	--	--	---

GTX-603838H3, GTX-603838H5

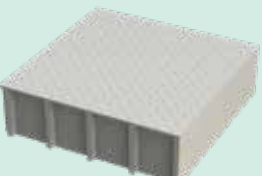
N

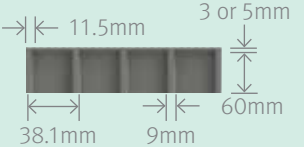
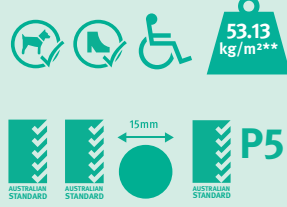
<p>Isometric View</p> 	<p>Plan View</p> 	<p>Elevation View</p> 	
---	--	--	---

Mesh Grid	Load Bar Details	Span (mm)	Load Type	Uniform load – ΔU (kN/m²) – Deflection (mm) Concentrated line load – ΔC (kN/m) – Deflection (mm)															
				3	5	8	10	15	20	25	30	40	50	60	80	90	100		

GTX-503838H3, GTX-503838H5

Mesh Grid	Load Bar Details	Span (mm)	Load Type	Uniform load – ΔU (kN/m²) – Deflection (mm) Concentrated line load – ΔC (kN/m) – Deflection (mm)															
				3	5	8	10	15	20	25	30	40	50	60	80	90	100		
38X38	50X11	200	ΔU	0.02	0.03	0.05	0.07	0.10	0.13	0.16	0.20	0.26	0.33	0.39	0.52	0.59	0.65		
			ΔC	0.04	0.07	0.11	0.14	0.20	0.27	0.34	0.41	0.54	0.68	0.81	1.09	1.22	1.36		
		400	ΔU	0.03	0.05	0.08	0.10	0.15	0.20	0.25	0.30	0.40	0.50	0.60	0.80	0.90	1.00		
			ΔC	0.12	0.19	0.31	0.38	0.58	0.77	0.96	1.15	1.54	1.92	2.30	3.07	3.46	3.84		
		600	ΔU	0.11	0.18	0.29	0.36	0.54	0.72	0.90	1.08	1.43	1.79	2.15	2.87	3.23	3.59		
			ΔC	0.31	0.52	0.83	1.04	1.56	2.08	2.60	3.12	4.16	5.20	6.24	8.32	9.36	10.40		
		800	ΔU	0.35	0.59	0.94	1.18	1.77	2.36	2.95	3.54	4.72	5.91	7.09	9.45	10.63	11.81		
			ΔC	0.72	1.20	1.92	2.40	3.60	4.80	6.00	7.20	9.60	11.99	14.39	19.19	21.59	23.99		
		1000	ΔU	0.90	1.50	2.39	2.99	4.49	5.99	7.48	8.98	11.97	14.96	17.96	23.94				
			ΔC	1.43	2.38	3.80	4.76	7.13	9.51	11.89	14.27	19.02	23.78						
		1200	ΔU	1.89	3.15	5.04	6.30	9.46	12.61	15.76	18.91	25.22							
			ΔC	2.52	4.20	6.73	8.41	12.61	16.81	21.02	25.22								
1400	ΔU	3.51	5.86	9.37	11.71	17.57	23.43												
	ΔC	4.09	6.82	10.92	13.65	20.47													
1600	ΔU	5.97	9.95	15.92	19.90														
	ΔC	6.23	10.38	16.61	20.77														

GratEX® Heavy Duty Solid Surface Mesh Specification

General

1.0 Scope

- 1.1 The grating shall conform to the material and fabrication requirements as per this specification.

2.0 Standards/Related documents

- 2.1 The grating system shall conform to the applicable sections of:
 - 2.1.1 ASTM E84 Surface Burning Characteristics of Building Materials
 - 2.1.2 ASTM D635 Rate of Burning and/or Extent and Time of Burning of Self-Supporting Plastics in a Horizontal Position.

3.0 Design Criteria

- 3.1 The design criteria of the fibreglass products (FRP) shall be in accordance with governing building codes and generally accepted standards in the FRP industry.
- 3.2 Design live loads shall be of ... kPa uniformly distributed load (or as per building code if more stringent) with a maximum deflection of ... mm at the centre of a single span according to product specifications.

4.0 Submittals

- 4.1 Shop drawings of all fabricated grating panels shall be submitted by Treadwell (unless provided by the client) displaying clearly material sizes, types, styles, product codes and including types and sizes of fasteners as well as a layout if required.
- 4.2 Technical data and sample pieces can also be submitted if required.

5.0 Quality Assurance

Quality surrounds every aspect of Treadwell's commitment to our superior products and efficiency. Treadwell's quality assurance strictly adheres to the high quality control standards placed to conform to relevant specifications, codes, Australian Standards and contractual requirements in a timely manner.

6.0 Product Delivery and Storage

- 6.1 All grating and components or ancillary items shall be fabricated as per the design and piece marked to design drawings.
- 6.2 All manufactured materials shall be delivered in unbroken packages.

Product System

7.0 Manufacturing Process

- 7.1 All fibreglass (FRP) items listed under this section shall be constructed from fibreglass reinforcement and resin of the quality necessary to meet the design requirements and dimensions as specified.
- 7.2 Fibreglass reinforcement shall be continuous roving and shall be in sufficient quantities as required for the application.
- 7.3 Resins shall be ... (refer to page 5) with chemical formulations as necessary to provide the corrosion resistance, strength and any other physical properties as required.
- 7.4 All finished surfaces to be smooth, resin-rich, free of voids and without dry spots, cracks or unreinforced areas and all fibreglass reinforcement shall be well covered with resin to protect against exposure due to weather or wear.
- 7.5 All fibreglass (FRP) items shall be EITHER non-fire retardant OR have a tested flame spread rating of 25 or less when tested in accordance with the ASTM E84 Tunnel Test.
- 7.6 Contact Treadwell regarding specification data relative to products conforming to ASTM D635.

- 7.7 All metal accessories shall be manufactured from (304 or 316) Stainless Steel, 2205 Duplex Stainless Steel, 2507 Super Duplex Stainless Steel, hot dipped galvanised steel or aluminium.
- 7.8 Load bars shall be joined with notched cross bars via interlocking methods and the use of chemical bonding.
- 7.9 The fibreglass reinforcement content shall be maintained at 65% (by weight) so as to achieve maximum loading capacity.
- 7.10 All fibreglass material shall have an ultraviolet light inhibiting chemical additive to resist UV degradation.
- 7.11 Grating shall be manufactured with a concave profile on top of each bar OR an anti-slip Aluminium Oxide surface to provide optimum slip resistance.

8.0 Acceptable Manufacturer

The fibreglass underfoot moulded grating system shall be manufactured by Treadwell Group Pty Ltd of Australia.

Ordering Information

Code

- 1. Nominate the type of grating required GTX = GratEX® Moulded Grating

Note: This section of the coding is typically separated from the next section of the coding by a dash (-)

- 2. Nominate the depth (mm) required 35, 50 and 60
- 3. Nominate the load bar centres required 3838 = 38mm x 38mm
- 4. Nominate the mesh type required H3 = Heavy Duty Solid Surface (3mm) Mesh
H5 = Heavy Duty Solid Surface (5mm) Mesh

Note: This section of the coding is typically separated from the next section of the coding by a dash (-)

- 5. Specify the resin, material or type (see page 6) O = O-Series®
I = I-Series®
V = V-Series®
P = P-Series®
- 6. Specify the colour required TY = Treadwell Yellow
DG = Dark Grey
LG = Light Grey
TG = Treadwell Green
CH = Charcoal
CC = Custom Colour
*In which instance a code and name of the selected colour must be mentioned within the description.
- 7. Specify the surface style required G1 = Barefoot Grade (Grit) Anti-Slip
G2 = Commercial Grade (Grit) Anti-Slip
G3 = Industrial Grade (Grit) Anti-Slip
G4 = Marine Grade (Grit) Anti-Slip
CH = Chequer Plate
DP = Diamond Plate
PL = Plain (Smooth)

Note: The next section of coding is separated by a dash (-), it isn't required for custom jobs as GratEX® is available in a variety of size panels to suit applications.

- 8. Nominate the panel size required 01 = 1225 mm x 3665 mm
02 = 920 mm x 3055 mm

Please refer to Appendix 3: GratEX® Ordering Codes - page 82

N Non-Stocked Item **C** Commonly Stocked Item

GratEX® Stair Treads



Treadwell's range of GratEX® Stair Treads includes both open surface and closed surface options, and a range of surface patterns, colour and leading edge nosing options.

All GratEX® Premium and Standard Stair Tread options are moulded with the Solid Leading Edge Nosing as an integrated single stage operation. This increases the rigidity and durability of the entire leading edge, ensuring reliable performance in high traffic scenarios. All the treads with abrasive leading edge nosings are manufactured to conform to AS 1657 – 2018.

The GratEX® Stair Tread nosings are typically stocked in colours that contrast by 30% with the primary tread colour as per AS 1657 – 2018. This ensures maximum visual awareness of the stair treads forward edge for personnel utilising the stairways and consequently enhancing the OHS safety ratings.

Treadwell recommends that leading edge nosings are specified when ordering GratEX® Stair Treads as the safety risks associated with elevated work areas or walkways are significantly increased without them.

NOTE: A bearing surface of at least 40mm is recommended at either side of GratEX® Stair Treads. Compliance with AS 1657 – 2018 requires a Tread depth of > 225mm.

Selecting a tread with lasting non-slip properties, resilience to corrosion and proven long term cost advantages can help you enhance safety in the workplace by reducing the chance of slips, trips and falls.



	Economy (STE)	Standard (STD)	Premium (STP)
GratEX® Square Mesh			
GratEX® Mini Mesh			
GratEX® Micro Mesh			

GratEX® Stair Treads



Note: The code suffix STS should be used in lieu of the suffix STP when a Premium Solid Block Leading Edge Nosing is required.

GratEX® Landings

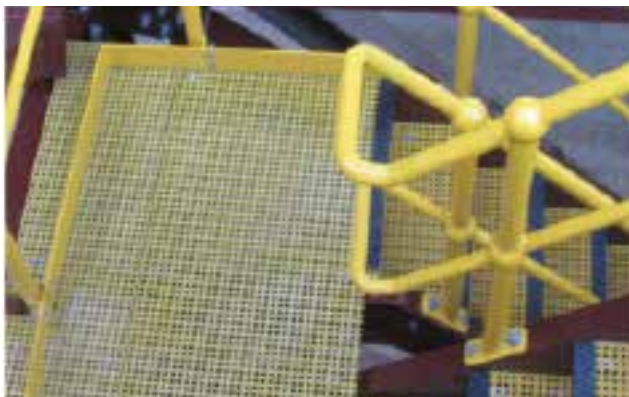

GratEX® landings are also available as a part of Treadwell's extensive range.

GratEX® landings combine the lasting non-slip properties, the resilience to corrosion and the proven long term cost advantages of GratEX® stair treads with the durable nature of GratEX® grating.

These landings are custom made for each and every application, greatly enhance visibility and reduce the wear commonly seen on landings immensely.

Contact Treadwell's technical assistance team for further details as drawings are required to accurately show nosing locations.

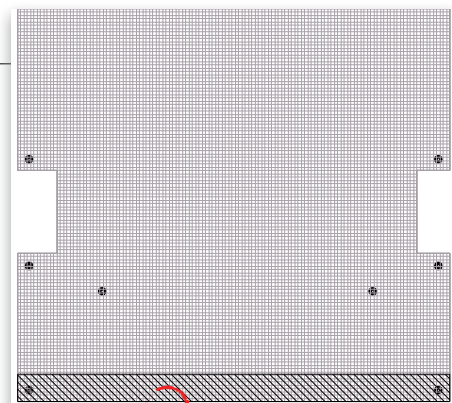
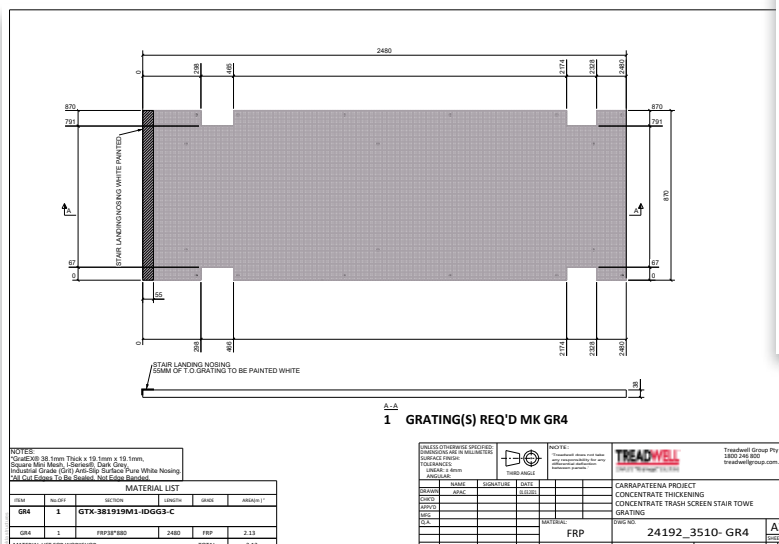

Tread Nosing

GratEX® Stair Treads

Safe Load & Deflection Charts (mm) - Distributed & Concentrated Loads in GratEX® Moulded FRP Stair Treads

AS 1657 suggests the minimum design loads on stair treads

Deflection (mm)									
Distributed loading 2.2kN per linear meter of stair tread width - Δu									
Concentrated Load 1.5kN at the centre of the tread span - Δc									
Mesh Grid	Tread Depth (mm)	Load Type	Span (mm)						
			616	730	768	806	844	882	958

GTX-383838SS									
38mm thick x 38.1mm x 38.1mm / 31.7mm x 31.7mm	235 (A)	Δu	1.9	3.8	4.6	5.6	6.7	8.0	
		Δc	3.5	5.7	6.6	7.6	8.7		
	273 (B)	Δu	1.7	3.2	4.0	4.8	5.8	6.9	9.6
		Δc	3.0	4.9	5.7	6.5	7.5		
	311 (C)	Δu	1.5	2.8	3.5	4.2	5.1	6.0	8.4
		Δc	2.6	4.3	5.0	5.7	6.6	7.5	
	349 (D)	Δu	1.3	2.5	3.1	3.8	4.5	5.4	7.5
		Δc	2.3	3.8	4.4	5.1	5.9	6.7	8.5

GTX-381919M1									
38mm thick x 19.1mm x 19.1mm / 12mm x 12mm	235 (A)	Δu	1.6	3.1	3.8	4.6	5.5	6.5	9.0
		Δc	2.8	4.6	5.3	6.1	7.0	7.9	
	273 (B)	Δu	1.4	2.7	3.3	3.9	4.7	5.6	7.7
		Δc	2.4	3.9	4.5	5.2	6.0	6.8	8.7
	311 (C)	Δu	1.2	2.4	2.9	3.5	4.1	4.9	6.8
		Δc	2.1	3.4	4.0	4.6	5.3	6.0	7.6
	349 (D)	Δu	1.1	2.1	2.6	3.1	3.7	4.4	6.1
		Δc	1.9	3.1	3.6	4.1	4.7	5.3	6.8

GTX-381919M2									
38mm thick x 13.3mm x 13.3mm / 7mm x 7mm	235 (A)	Δu	1.7	3.2	3.8	4.6	5.5	6.5	9.0
		Δc	2.8	4.5	5.2	6.0	6.9	7.8	
	273 (B)	Δu	1.5	2.7	3.3	4.0	4.7	5.6	7.7
		Δc	2.4	3.9	4.5	5.2	5.9	6.8	8.6
	311 (C)	Δu	1.3	2.4	2.9	3.5	4.1	4.9	6.8
		Δc	2.1	3.4	3.9	4.5	5.2	5.9	7.6
	349 (D)	Δu	1.2	2.1	2.6	3.1	3.7	4.4	6.0
		Δc	1.9	3.0	3.5	4.0	4.6	5.3	6.8

Deflection (mm)									
Distributed loading 2.2kN per linear meter of stair tread width - Δu									
Concentrated Load 1.5kN at the centre of the tread span - Δc									
	Tread Depth (mm)	Load Type	Span (mm)						
			616	717	819	920	1022	1124	1175

GTX-505050SS									
50mm thick x 50.8mm x 50.8mm	260 (A)	Δu	1.05	1.84	3.03	4.72	7.06	10.20	
		Δc	1.83	2.77	4.01	5.57	7.53	9.91	11.27
	311 (B)	Δu	0.88	1.54	2.53	3.94	5.90	8.53	10.13
		Δc	1.53	2.32	3.36	4.67	6.30	8.29	9.43

GratEX® Stair Treads

Ordering Information

Code

1. Nominate the type of grating required	GTX = GratEX® Moulded Grating	
Note: This section of the coding is typically separated from the next section of the coding by a dash (-)		
2. Choose the depth (mm) required	25, 30, 38, 50	
3. Select the load bar centres required	1313 = 13mm x 13mm 1919 = 19mm x 19mm 2020 = 20mm x 20mm	2525 = 25mm x 25mm 3838 = 38mm x 38mm 5050 = 50mm x 50mm
4. Select the mesh type required	SS = Square mesh M1 = Mini Mesh M2 = Micro Mesh	SR = Rectangular F3 = Solid Surface (3mm) F5 = Solid Surface (5mm)
Note: This section of the coding is typically separated from the next section of the coding by a dash (-)		
5. Select the resin, material or type (see page 6)	O = O-Series® I = I-Series® V = V-Series® P = P-Series®	
6. Choose the tread colour required (*In which instance a code and name of the selected colour must be mentioned within the description)	TY = Treadwell Yellow DG = Dark Grey LG = Light Grey TG = Treadwell Green CH = Charcoal CC = Custom Colour	
7. Select the surface style required	G1 = Barefoot Grade (Grit) Anti-Slip G2 = Commercial Grade (Grit) Anti-Slip G3 = Industrial Grade (Grit) Anti-Slip G4 = Marine Grade (Grit) Anti-Slip CO = Concave PL = Plain (Smooth) CH = Chequer Plate DP = Diamond Plate	
8. Nominate the stair tread type	STE = Economy STP = Premium	STC = Custom STD = Standard
Note: This section of the coding is typically separated from the next section of the coding by a dash (-)		
9. Select the nosing colour required (*In which instance a code and name of the selected colour must be mentioned within the description)	B = Jet Black Y = Safety Yellow W = Pure White	H = Chevron (two tone) C = Custom*
Note: This section of the coding is typically separated from the next section of the coding by a dash (-)		
10. Select the Stair Tread Depth	A=235mm B=273mm C=311mm D=349mm	
11. Select the Stair Tread Width (mm)	Required Width	EXAMPLE: GTX-383838SS-IDGG3-STP-Y-B730

GratEX® Stair Treads

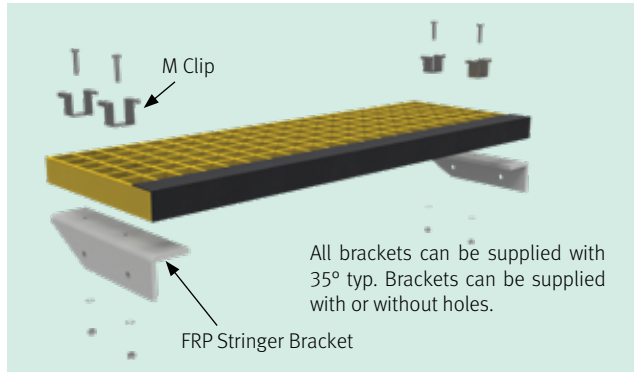

GratEX® Stair Treads Retro-fit Option

GratEX® Stair Treads Kits offer a complete ‘change out’ package to replace existing stair treads and stringer bracket assemblies that have suffered premature corrosion.

Traditionally, stringer bracket assemblies are made from metallic materials which require corrosion inhibiting coatings to ensure satisfactory life span. It is typical for stair tread mounting brackets to be drilled in situ after this coating has been applied, thus compromising the integrity of this first line of defence against corrosion. It is also common for stringer brackets to be constructed of lighter walled material than other adjacent componentry such as stringers.

These kits have been adopted as a superior replacement for the originally specified equipment in many instances as well as being chosen as a long life and cost saving alternative to metallic systems in numerous new plants.

Tread kits are available in all resin systems and are supplied with M-Clips as standard. Treads can be supplied assembled ready for installation or ready for assembly onsite. Likewise, stringer support brackets can be supplied with pre-drilled mounting holes if specified. Treadwell does not recommend the use of stair treads with a thickness of less than 25mm.

GratEX® Ezy Tread Stair Treads

If the required stair tread span exceeds standard lengths, the expected concentrated load exceeds 4.5kN, and/or the stair treads deflection goes beyond the range accepted in Australian standards and compliance codes, Treadwell’s ArchiTEX™ FRP equal leg angle must be assembled as part of the structure. This will be installed along the length of the stair tread to provide additional support and address safety concerns.

DURABLE, HARD-WEARING, ANTI SLIP SURFACE

Outperforms steel, concrete and other traditional materials, ensuring dependability in high traffic situations.

HIGH STRENGTH FRP LEDGER ANGLE

Provides the additional support to eliminate deflection, enhancing performance under high load instances

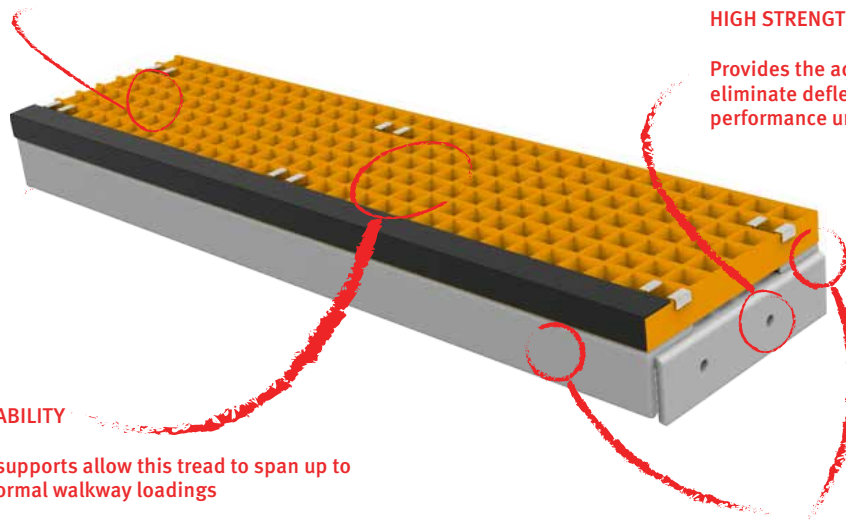

BRILLIANT SPAN-ABILITY

High quality FRP supports allow this tread to span up to 1800mm under normal walkway loadings

INCREDIBLE RIGIDITY

The sturdy FRP Equal Leg Angle support under the front and back of the tread provides exceptional rigidity.

Fastening Clips & Installation Methods



Installation Accessories

The GratEX® moulded FRP grating products are complimented by an extensive range of fixing types and installation systems. All GratEX® installation clip sets are tested and proven to function in the harshest of applications, offering you total peace of mind.

All of the GratEX® installation systems are supplied and stocked as 316 grade stainless steel with super duplex, 304 grade stainless and galvanised steel options available upon request. This flexibility means that we can provide a suitable solution for whatever chemicals or application you have.

The GratEX® clip range also includes a large range of underside clips which provides additional options when designing sub-structures with the consideration of fixing methods. Refer to the StormChief® page for information on our unique range of extreme strength clip options for high wave action zones.

GratEX® Clip - Tops

STANDARD M	3D	PLAN	ELEVATION	FASTENING OPTIONS
Hole Diameter: 8mm Material type: 316 st/st Threaded hole: N/A				1, 3, 4, 6
MINI MESH M	3D	PLAN	ELEVATION	FASTENING OPTIONS
Hole Diameter: 6mm (8mm for GTX-502525M1) Material type: 316 st/st Threaded hole: N/A				5, 7
MINI MESH M (SLOTTED)	3D	PLAN	ELEVATION	FASTENING OPTIONS
Hole Diameter: 6mm Material type: 316 st/st Threaded hole: N/A				5, 7
C	3D	PLAN	ELEVATION	FASTENING OPTIONS
Hole Diameter: 6mm Material type: 316 st/st Threaded hole: Yes				2
L	3D	PLAN	ELEVATION	FASTENING OPTIONS
Hole Diameter: 6.5mm Material type: 316 st/st Threaded hole: N/A				2
D	3D	PLAN	ELEVATION	FASTENING OPTIONS
Hole Diameter: 8.5mm, 7mm Material type: 316 st/st Threaded hole: N/A				1, 3, 4, 6
E	3D	PLAN	ELEVATION	FASTENING OPTIONS
Hole Diameter: 8mm Material type: 316 st/st Threaded hole: N/A				1, 3, 4, 6
W	3D	PLAN	ELEVATION	FASTENING OPTIONS
Hole Diameter: 8mm Material type: 316 st/st Threaded hole: N/A				1, 3, 4, 6
S	3D	PLAN	ELEVATION	FASTENING OPTIONS
Hole Diameter: 8mm Material type: 316 st/st Threaded hole: N/A				5, 7
O	3D	PLAN	ELEVATION	FASTENING OPTIONS
Hole Diameter: 8mm Material type: 316 st/st Threaded hole: N/A				10,11

Not drawn to scale

Fastening Clips & Installation Methods

Clamp Underside

J - UNIVERSAL	3D	PLAN	ELEVATION	SIDE ELEVATION	FASTENING OPTIONS
Hole Diameter: N/A Material type: 316 st/st Threaded hole: N/A					1, 3, 4
J - MINI-MESH	3D	PLAN	ELEVATION	SIDE ELEVATION	FASTENING OPTIONS
Hole Diameter: N/A Material type: 316 st/st Threaded hole: N/A					5
H	3D	PLAN	ELEVATION	FASTENING OPTIONS	
Hole Diameter: 8mm Material type: st/st Threaded hole: Yes				1, 3, 4, 11	
G	3D	PLAN	ELEVATION	FASTENING OPTIONS	
Hole Diameter: 6mm, 8mm Material type: st/st Threaded hole: Yes				2	
U	3D	PLAN	ELEVATION	FASTENING OPTIONS	
Hole Diameter: 8mm Material type: 316 st/st Threaded hole: Yes				1, 3, 4	
V	3D	PLAN	ELEVATION	FASTENING OPTIONS	
Hole Diameter: 8mm Material type: 316 st/st Threaded hole: N/A				1, 3, 4	
T	3D	PLAN	ELEVATION	FASTENING OPTIONS	
Hole Diameter: N/A Material type: 316 st/st Threaded hole: N/A				1, 3, 4, 9	

Fastening Options

1	2	3	4	5	
FAS-S-HX-M8-40-316 M8 x 40mm Hex Head Set Screw, 316 Grade Stainless Steel, c/w nylon nut and washer.	FAS-S-HX-M6-40-316 M6 x 40mm Hex Head Set Screw, 316 Grade Stainless Steel, c/w nylon nut and washer.	FAS-S-SH-M8-40-316 M8 x 40mm Socket Head Cap Screw, 316 Grade Stainless Steel, c/w nylon nut and washer.	FAS-S-BS-M8-40-316 M8 x 40mm Button Socket Head Cap Screw, 316 Grade Stainless Steel, c/w nylon nut and washer.	FAS-S-SH-M5-50-316 M5 x 50mm Socket Head Cap Screw, 316 Grade Stainless Steel, c/w nylon nut and washer.	
6	7	8	9	10	11
FAS-SD-HX-G14-50-316 G14 x 50mm Hex Head Type 17 Self Drilling Screw, 316 Grade Stainless Steel.	FAS-SD-TX-G12-50-316 G12 x 50mm Torx Head Type 17 Self Drilling Screw, 316 Grade Stainless Steel.	FAS-SD-WH-G14-70-316 G14 x 70mm Washer Face Hex Head Type 17 Self Drilling Screw, 316 Grade Stainless Steel.	FAS-S-HX-M8-50-316 M8 x 50mm Hex Head Set Screw, 316 Grade Stainless Steel.	FAS-SD-CT-G14-50-316 G14 x 50mm Countersunk Bugle Type 17 Self Drilling Screw, 316 Grade Stainless Steel.	FAS-S-CT-M8-50-316 M8 x 50mm Countersunk Socket Head Cap Screw, 316 Grade Stainless Steel, c/w nylon nut and washer.

Not drawn to scale

Fastening Profiles Ordering Information:

Please refer to Appendix 6a: GratEX® Fasteners Ordering Information.

Fastening Clip Frequency Recommendation:

Treadwell recommends that at least 4 GratEX® clip sets be installed per panel, regardless of size, or approximately 4 per m² for areas exceeding 1 m². If you have a unique requirement, chances are we have encountered something similar before – contact Treadwell on 1800 246 800.

Fixing Assembly Combinations

<p>Standard M Clip Assembly</p> <p>M8 Hex Head Set Screw</p> <p>GratEX® Type M Clip</p> <p>GratEX® Standard Square Mesh</p> <p>Flat Washer</p> <p>Lock Nut</p>	<p>L Clip Assembly</p> <p>M6 Hex Head Set Screw</p> <p>GratEX® Type L Clip</p> <p>GratEX® Standard Square Mesh</p> <p>Flat Washer</p> <p>Lock Nut</p>
<p>Mini M Clip Assembly</p> <p>M5 Socket Head Cap Screw</p> <p>GratEX® Type Mini M Clip</p> <p>GratEX® Mini Mesh</p> <p>Flat Washer</p> <p>Lock Nut</p>	<p>D Clip Assembly</p> <p>M6 or M8 Hex Head Set Screw</p> <p>GratEX® Type D Clip</p> <p>GratEX® Standard Square Mesh</p> <p>Flat Washer</p> <p>Lock Nut</p>
<p>Standard C Clip Assembly</p> <p>M6 Hex Head Set Screw</p> <p>GratEX® Type C Clip</p> <p>GratEX® Standard Square Mesh</p>	<p>E Clip Assembly</p> <p>M8 Hex Head Set Screw</p> <p>GratEX® Type E Clip</p> <p>GratEX® Standard Square Mesh</p> <p>Flat Washer</p> <p>Lock Nut</p>

Not drawn to scale

Fixing Assembly Combinations

S Clip Assembly	Micro Mesh Assembly
<p>M8 Hex Head Set Screw</p> <p>GratEX® Standard Square Mesh</p> <p>GratEX® Type S Clip</p> <p>Flat Washer</p> <p>Lock Nut</p>	<p>M8 Countersunk Socket Head Cap Screw</p> <p>GratEX® Micro Mesh</p> <p>GratEX® Type UNIVERSAL J Clip</p> <p>Lock Nut</p>

S Clip Installation Tool	Solid Surface Recess Tool
<p>Treadwell provides 38mm and 50mm S clips according to the needs of clients. To facilitate the sizes, our quality installation tools come in 32mm and 44mm to suit the size of each aperture.</p>	

W Clip Assembly	OH Clip Assembly
<p>GratEX® Type W Clip</p> <p>M8 Hex Head Set Screw</p> <p>GratEX® Solid Top Grating</p> <p>Flat Washer</p> <p>Lock Nut</p>	<p>M8 Countersunk Socket Head Cap Screw</p> <p>GratEX® Solid Top Grating</p> <p>Recessed Hole for O Clip</p> <p>GratEX® Type H Clip</p> <p>GratEX® Type O Clip</p>

Not drawn to scale

Fixing Assembly Combinations

MJ Clip Assembly

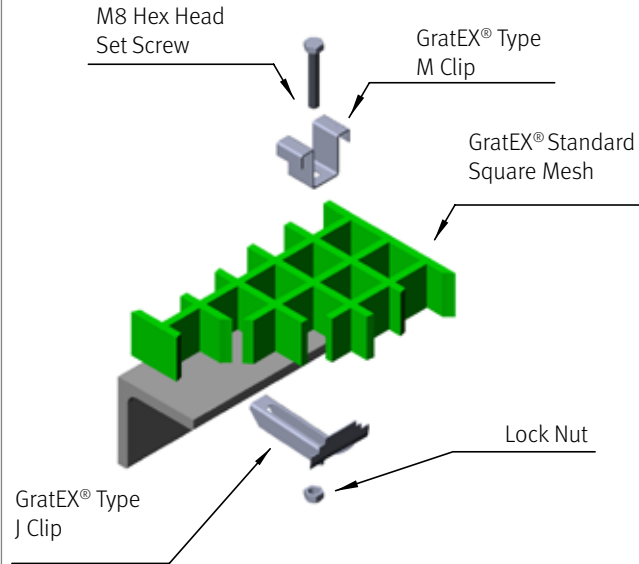

MH Clip Assembly

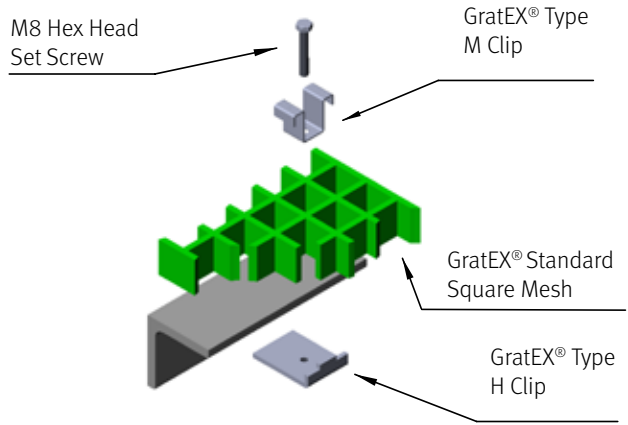

MU Clip Assembly

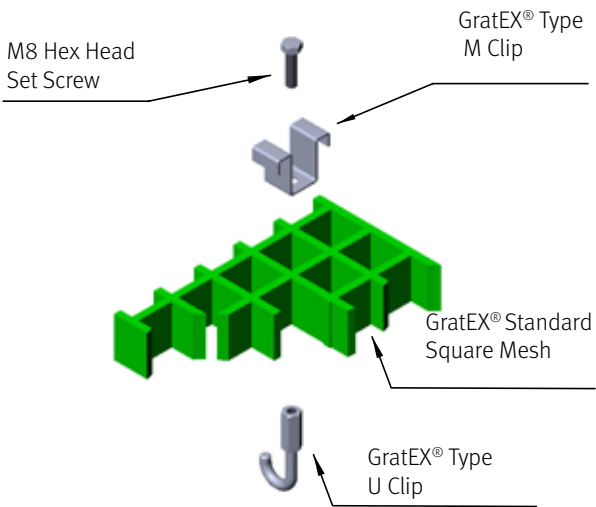

MV Clip Assembly

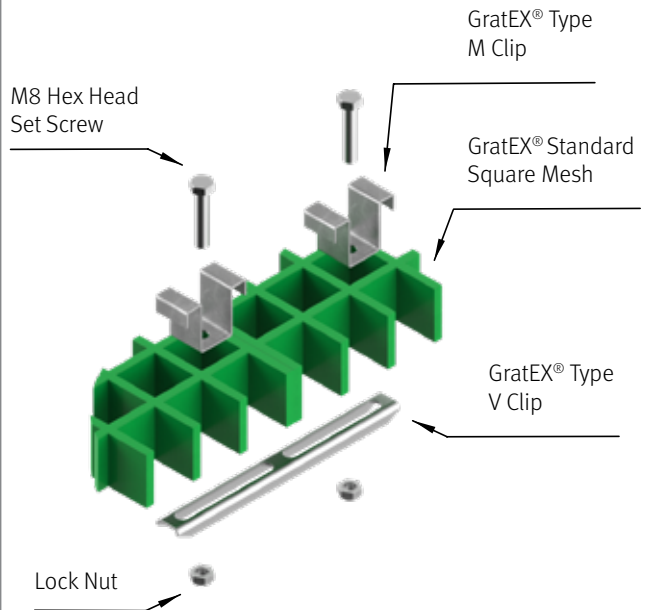

Not drawn to scale

Fixing Assembly Combinations

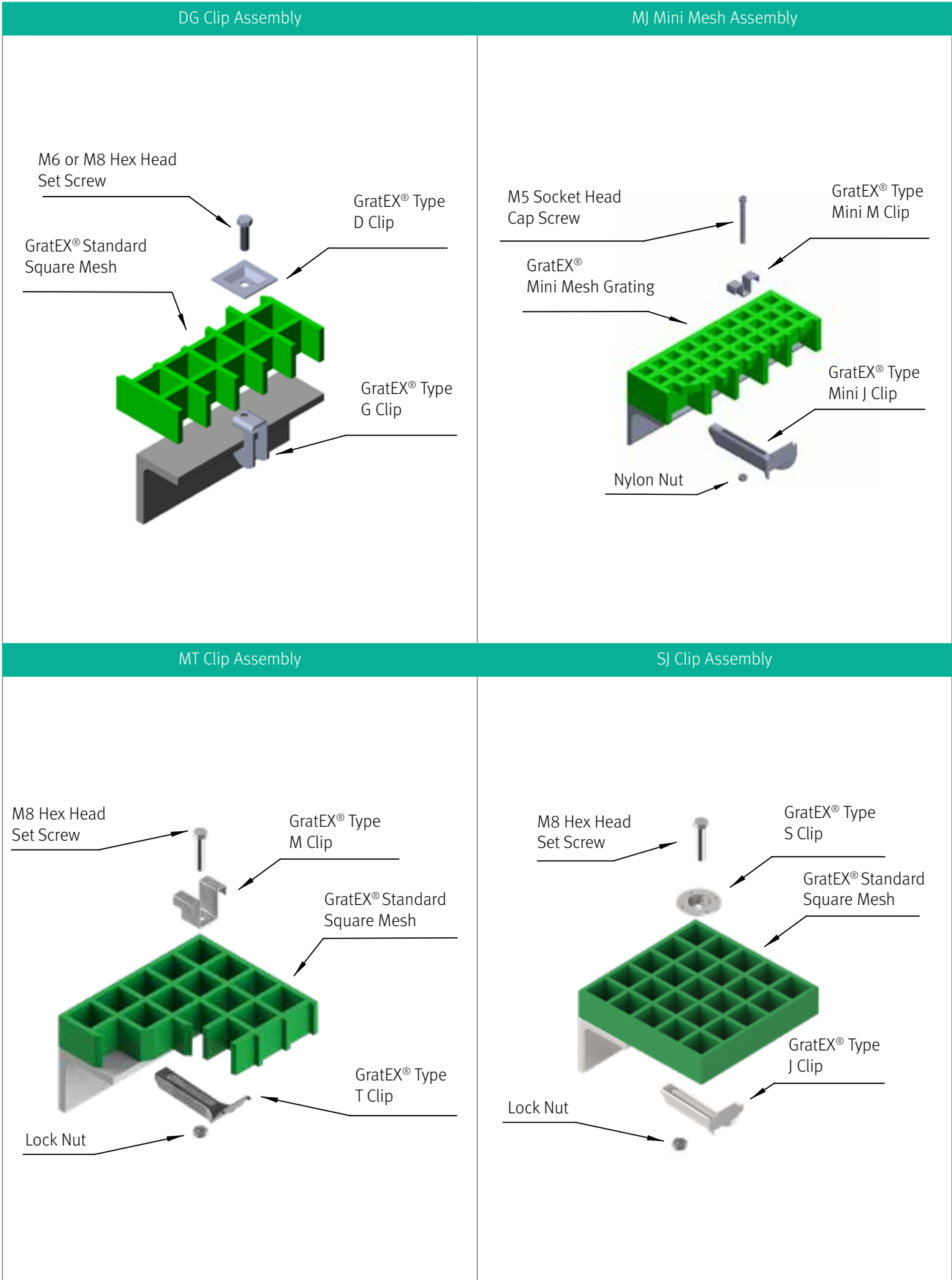

Not drawn to scale

Fixing Assembly Combinations

WJ Mini Mesh Assembly

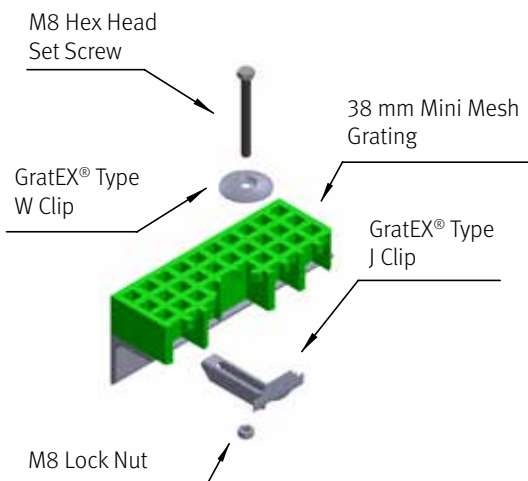

WH Solid Top Assembly

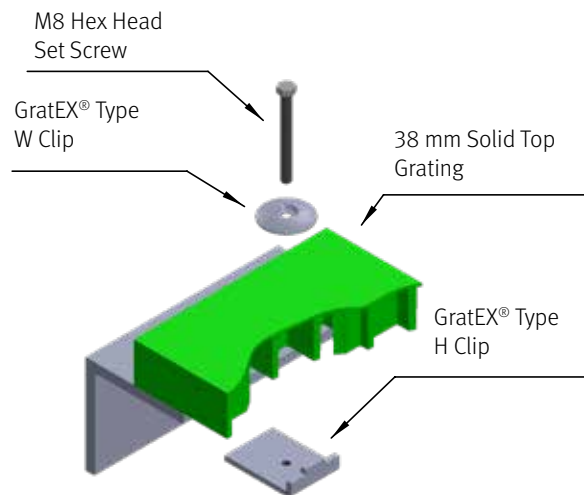

M Clip Masonry Anchor Assembly

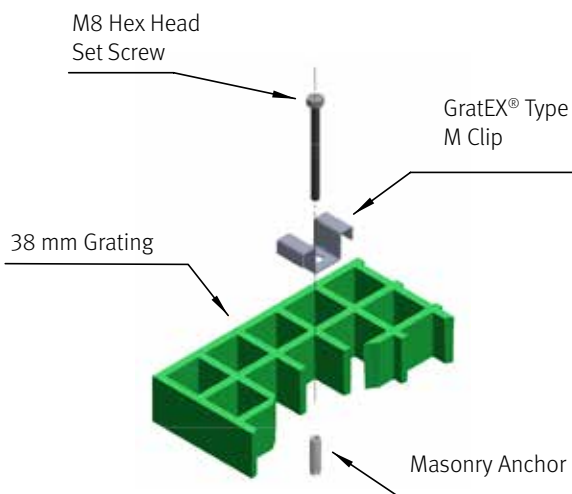

W Clip Masonry Anchor Solid Top Assembly

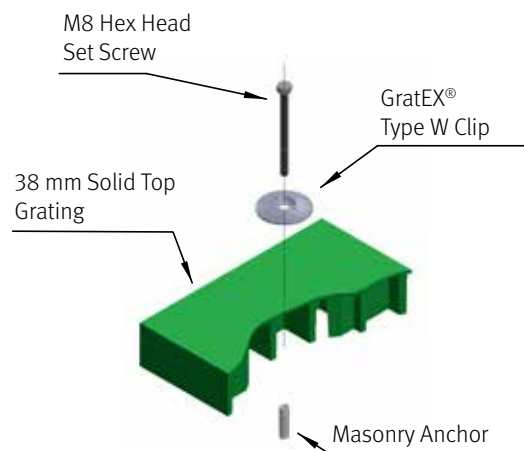

Not drawn to scale

Closed Load Bar Charts

80 x 80 Mesh Grid Load Bar Chart

No. of Bars	mm								
2	86.4	12	886.4	22	1686.4	32	2486.4	42	3286.4
3	166.4	13	966.4	23	1766.4	33	2566.4	43	3366.4
4	246.4	14	1046.4	24	1846.4	34	2646.4	44	3446.4
5	326.4	15	1126.4	25	1926.4	35	2726.4	45	3526.4
6	406.4	16	1206.4	26	2006.4	36	2806.4	46	3606.4
7	486.4	17	1286.4	27	2086.4	37	2886.4	47	3686.4
8	566.4	18	1366.4	28	2166.4	38	2966.4	48	3766.4
9	646.4	19	1446.4	29	2246.4	39	3046.4	49	3846.4
10	726.4	20	1526.4	30	2326.4	40	3126.4	50	3926.4
11	806.4	21	1606.4	31	2406.4	41	3206.4	51	4006.4

GratEX® Heavy Duty Mesh 38.1 x 38.1 Heavy Duty Mesh Grid Load Bar Chart

No. of Bars	mm								
2	48.6	22	810.6	42	1572.6	62	2334.6	82	3096.6
3	86.7	23	848.7	43	1610.7	63	2372.7	83	3134.7
4	124.8	24	886.8	44	1648.8	64	2410.8	84	3172.8
5	162.9	25	924.9	45	1686.9	65	2448.9	85	3210.9
6	201.0	26	963.0	46	1725.0	66	2487.0	86	3249.0
7	239.1	27	1001.1	47	1763.1	67	2525.1	87	3287.1
8	277.2	28	1039.2	48	1801.2	68	2563.2	88	3325.2
9	315.3	29	1077.3	49	1839.3	69	2601.3	89	3363.3
10	353.4	30	1115.4	50	1877.4	70	2639.4	90	3401.4
11	391.5	31	1153.5	51	1915.5	71	2677.5	91	3439.5
12	429.6	32	1191.6	52	1953.6	72	2715.6	92	3477.6
13	467.7	33	1229.7	53	1991.7	73	2753.7	93	3515.7
14	505.8	34	1267.8	54	2029.8	74	2791.8	94	3553.8
15	543.9	35	1305.9	55	2067.9	75	2829.9	95	3591.9
16	582.0	36	1344.0	56	2106.0	76	2868.0	96	3630.0
17	620.1	37	1382.1	57	2144.1	77	2906.1	97	3668.1
18	658.2	38	1420.2	58	2182.2	78	2944.2	98	3706.2
19	696.3	39	1458.3	59	2220.3	79	2982.3	99	3744.3
20	734.4	40	1496.4	60	2258.4	80	3020.4	100	3782.4
21	772.5	41	1534.5	61	2296.5	81	3058.5	101	3820.5

Note: The figures are indicative or an estimate only. This is a guide and an allowance for manufacturing tolerances (page 70) should be made.

GratEX® Mini-Mesh 19.05 x 19.05 Mini Mesh Grid Load Bar Chart

No. of Bars	mm																		
2	26.1	12	216.6	22	407.1	32	597.6	42	788.0	52	978.5	62	1169.1	72	1359.6	82	1550.1	92	1740.6
3	45.1	13	235.6	23	426.1	33	616.6	43	807.1	53	997.6	63	1188.1	73	1378.6	83	1569.1	93	1759.6
4	64.2	14	254.7	24	445.2	34	635.7	44	826.1	54	1016.7	64	1207.2	74	1397.7	84	1588.2	94	1778.7
5	83.2	15	273.7	25	464.2	35	654.7	45	845.2	55	1035.7	65	1226.2	75	1416.7	85	1607.2	95	1797.7
6	102.3	16	292.8	26	483.3	36	673.8	46	864.2	56	1054.8	66	1245.3	76	1435.8	86	1626.3	96	1816.8
7	121.3	17	311.8	27	502.3	37	692.8	47	883.3	57	1073.8	67	1264.3	77	1454.8	87	1645.3	97	1835.8
8	140.4	18	330.9	28	521.4	38	711.9	48	902.3	58	1092.9	68	1283.4	78	1473.9	88	1664.4	98	1854.9
9	159.4	19	349.9	29	540.4	39	730.9	49	921.4	59	1111.9	69	1302.4	79	1492.9	89	1683.4	99	1873.9
10	178.5	20	369.0	30	559.5	40	750.0	50	940.4	60	1131.0	70	1321.5	80	1512.0	90	1702.5	100	1893.0
11	197.5	21	388.0	31	578.5	41	769.0	51	959.5	61	1150.0	71	1340.5	81	1531.0	91	1721.5	101	1912.0

Note: The figures are indicative or an estimate only. This is a guide and an allowance for manufacturing tolerances (page 70) should be made.

Closed Load Bar Charts

GratEX® Mini-Mesh 20 x 20 Mini Mesh Grid Load Bar Chart

No. of Bars	mm																				
2	27.0	20	387.0	38	747.0	56	1107.0	74	1467.0	92	1827.0	110	2187.0	128	2547.0	146	2907.0	164	3267.0	182	3627.0
3	47.0	21	407.0	39	767.0	57	1127.0	75	1487.0	93	1847.0	111	2207.0	129	2567.0	147	2927.0	165	3287.0	183	3647.0
4	67.0	22	427.0	40	787.0	58	1147.0	76	1507.0	94	1867.0	112	2227.0	130	2587.0	148	2947.0	166	3307.0	184	3667.0
5	87.0	23	447.0	41	807.0	59	1167.0	77	1527.0	95	1887.0	113	2247.0	131	2607.0	149	2967.0	167	3327.0	185	3687.0
6	107.0	24	467.0	42	827.0	60	1187.0	78	1547.0	96	1907.0	114	2267.0	132	2627.0	150	2987.0	168	3347.0	186	3707.0
7	127.0	25	487.0	43	847.0	61	1207.0	79	1567.0	97	1927.0	115	2287.0	133	2647.0	151	3007.0	169	3367.0	187	3727.0
8	147.0	26	507.0	44	867.0	62	1227.0	80	1587.0	98	1947.0	116	2307.0	134	2667.0	152	3027.0	170	3387.0	188	3747.0
9	167.0	27	527.0	45	887.0	63	1247.0	81	1607.0	99	1967.0	117	2327.0	135	2687.0	153	3047.0	171	3407.0	189	3767.0
10	187.0	28	547.0	46	907.0	64	1267.0	82	1627.0	100	1987.0	118	2347.0	136	2707.0	154	3067.0	172	3427.0	190	3787.0
11	207.0	29	567.0	47	927.0	65	1287.0	83	1647.0	101	2007.0	119	2367.0	137	2727.0	155	3087.0	173	3447.0	191	3807.0
12	227.0	30	587.0	48	947.0	66	1307.0	84	1667.0	102	2027.0	120	2387.0	138	2747.0	156	3107.0	174	3467.0	192	3827.0
13	247.0	31	607.0	49	967.0	67	1327.0	85	1687.0	103	2047.0	121	2407.0	139	2767.0	157	3127.0	175	3487.0	193	3847.0
14	267.0	32	627.0	50	987.0	68	1347.0	86	1707.0	104	2067.0	122	2427.0	140	2787.0	158	3147.0	176	3507.0	194	3867.0
15	287.0	33	647.0	51	1007.0	69	1367.0	87	1727.0	105	2087.0	123	2447.0	141	2807.0	159	3167.0	177	3527.0	195	3887.0
16	307.0	34	667.0	52	1027.0	70	1387.0	88	1747.0	106	2107.0	124	2467.0	142	2827.0	160	3187.0	178	3547.0	196	3907.0
17	327.0	35	687.0	53	1047.0	71	1407.0	89	1767.0	107	2127.0	125	2487.0	143	2847.0	161	3207.0	179	3567.0	197	3927.0
18	347.0	36	707.0	54	1067.0	72	1427.0	90	1787.0	108	2147.0	126	2507.0	144	2867.0	162	3227.0	180	3587.0	198	3947.0
19	367.0	37	727.0	55	1087.0	73	1447.0	91	1807.0	109	2167.0	127	2527.0	145	2887.0	163	3247.0	181	3607.0	199	3967.0

Note: The figures are indicative or an estimate only. This is a guide and an allowance for manufacturing tolerances (page 70) should be made.

25.4 x 25.4 Mini Mesh Grid Load Bar Chart

No. of Bars	mm																				
2	33.4	16	389.0	30	744.6	44	1100.2	58	1455.8	72	1811.4	86	2167.0	100	2522.6	114	2878.2	128	3233.8	142	3589.4
3	58.8	17	414.4	31	770.0	45	1125.6	59	1481.2	73	1836.8	87	2192.4	101	2548.0	115	2903.6	129	3259.2	143	3614.8
4	84.2	18	439.8	32	795.4	46	1151.0	60	1506.6	74	1862.2	88	2217.8	102	2573.4	116	2929.0	130	3284.6	144	3640.2
5	109.6	19	465.2	33	820.8	47	1176.4	61	1532.0	75	1887.6	89	2243.2	103	2598.8	117	2954.4	131	3310.0	145	3665.6
6	135.0	20	490.6	34	846.2	48	1201.8	62	1557.4	76	1913.0	90	2268.6	104	2624.2	118	2979.8	132	3335.4	146	3691.0
7	160.4	21	516.0	35	871.6	49	1227.2	63	1582.8	77	1938.4	91	2294.0	105	2649.6	119	3005.2	133	3360.8	147	3716.4
8	185.8	22	541.4	36	897.0	50	1252.6	64	1608.2	78	1963.8	92	2319.4	106	2675.0	120	3030.6	134	3386.2	148	3741.8
9	211.2	23	566.8	37	922.4	51	1278.0	65	1633.6	79	1989.2	93	2344.8	107	2700.4	121	3056.0	135	3411.6	149	3767.2
10	236.6	24	592.2	38	947.8	52	1303.4	66	1659.0	80	2014.6	94	2370.2	108	2725.8	122	3081.4	136	3437.0	150	3792.6
11	262.0	25	617.6	39	973.2	53	1328.8	67	1684.4	81	2040.0	95	2395.6	109	2751.2	123	3106.8	137	3462.4	151	3818.0
12	287.4	26	643.0	40	998.6	54	1354.2	68	1709.8	82	2065.4	96	2421.0	110	2776.6	124	3132.2	138	3487.8	152	3843.4
13	312.8	27	668.4	41	1024.0	55	1379.6	69	1735.2	83	2090.8	97	2446.4	111	2802.0	125	3157.6	139	3513.2	153	3868.8
14	338.2	28	693.8	42	1049.4	56	1405.0	70	1760.6	84	2116.2	98	2471.8	112	2827.4	126	3183.0	140	3538.6	154	3894.2
15	363.6	29	719.2	43	1074.8	57	1430.4	71	1786.0	85	2141.6	99	2497.2	113	2852.8	127	3208.4	141	3564.0	155	3919.6

Note: The figures are indicative or an estimate only. This is a guide and an allowance for manufacturing tolerances (page 70) should be made.

Closed Load Bar Charts

GratEX® Rectangular Mesh 25 x 152 Mesh Grid Load Bar Chart

No. of Bars	mm	(Length)							
2	158.4	10	1374.4	18	2590.4	26	3806.4	34	5022.4
3	310.4	11	1526.4	19	2742.4	27	3958.4	35	5174.4
4	462.4	12	1678.4	20	2894.4	28	4110.4	36	5326.4
5	614.4	13	1830.4	21	3046.4	29	4262.4	37	5478.4
6	766.4	14	1982.4	22	3198.4	30	4414.4	38	5630.4
7	918.4	15	2134.4	23	3350.4	31	4566.4	39	5782.4
8	1070.4	16	2286.4	24	3502.4	32	4718.4	40	5934.4
9	1222.4	17	2438.4	25	3654.4	33	4870.4	41	6086.4

No. of Bars	mm	(Width)							
2	31.4	10	231.4	18	431.4	26	631.4	34	831.4
3	56.4	11	256.4	19	456.4	27	656.4	35	856.4
4	81.4	12	281.4	20	481.4	28	681.4	36	881.4
5	106.4	13	306.4	21	506.4	29	706.4	37	906.4
6	131.4	14	331.4	22	531.4	30	731.4	38	931.4
7	156.4	15	356.4	23	556.4	31	756.4	39	956.4
8	181.4	16	381.4	24	581.4	32	781.4	40	981.4
9	206.4	17	406.4	25	606.4	33	806.4	41	1006.4

Note: The figures are indicative or an estimate only. This is a guide and an allowance for manufacturing tolerances (page 70) should be made.

38 x 100 Mesh Grid Load Bar Chart

No. of Bars	mm	(Length)							
2	106.4	7	606.4	12	1106.4	17	1606.4	22	2106.4
3	206.4	8	706.4	13	1206.4	18	1706.4	23	2206.4
4	306.4	9	806.4	14	1306.4	19	1806.4	24	2306.4
5	406.4	10	906.4	15	1406.4	20	1906.4	25	2406.4
6	506.4	11	1006.4	16	1506.4	21	2006.4	26	2506.4

No. of Bars	mm	(Width)							
2	44.4	7	234.4	12	424.4	17	614.4	22	804.4
3	82.4	8	272.4	13	462.4	18	652.4	23	842.4
4	120.4	9	310.4	14	500.4	19	690.4	24	880.4
5	158.4	10	348.4	15	538.4	20	728.4	25	918.4
6	196.4	11	386.4	16	576.4	21	766.4	26	956.4

Note: The figures are indicative or an estimate only. This is a guide and an allowance for manufacturing tolerances (page 70) should be made.

Benefits of FRP



Design Flexibility

The unique capabilities of conforming partial functionality to the use or application, ease to manufacture and to personalise shapes and aesthetics are just some of the key benefits that draw designers, engineers and architects to composite materials.



Competitive Vs Traditional Materials

FRP is manufactured from a more economically sound raw material base than metallic alternatives, and is far more structurally sound when compared to timber and plastic materials.

LadderEX® FRP Ladders

LadderEX® is the choice alternative to metallic ladders and cage systems, providing superior corrosion resistance and electrical transparency. Even in complete submersion applications, our FRP ladders have outlasted aluminium and steel and required little maintenance or care.

The product range in Treadwell's ladder and platform systems include fibreglass platforms, fibreglass ladders, fibreglass caged ladders, FRP walkways and other such customisations in FRP based configurations which are offered in the following categories:

- Complete FRP Access Fibreglass Platforms Structure
- Fibreglass Caged Ladder System



MoultrEX® Moultruded Fibreglass Grating

What is MoultrEX® Moultruded Fibreglass Grating

Treadwell's MoultrEX® fibreglass moultruded grating is the first open mesh grating ever to combine the high performance values of fibreglass reinforced plastic (FRP) moulded grating with the amazing capabilities of pultrusion. This has been achieved through clever utilisation of pultrusions within the body of the products' load bars and boasts greater amounts of glass in every item than have ever been seen previously. With the introduction of this revolutionary product, a new vista of grating products is now available to meet both the needs and demands of pedestrian and industrial applications.

Engineered to be lighter than metallic alternatives, MoultrEX® is Treadwell's remarkable hybrid of GratEX®'s moulded and GridEX® pultruded systems. It offers excellent load bearing and resilience characteristics, whilst upholding the highest level of resistance to the elements and corrosives.

The product is also aesthetically pleasing and ideally suited to use in public areas where both smaller apertures ensure compliance with relevant codes, and where requirements for a higher level of finish are called for.



MoultrEX® Features and Benefits vs. Traditional Alternatives

	MoultrEX®	Stainless Steel	Galvanised Steel	Aluminium	Polyurethane
Chemical Resistance	•••••	•••••	•	•••	•••••
Strength	•••••	•••••	•••••	•••••	•••
Lightweight	•••••	•	•	•••••	•••
Electrical Resistance	•••••	•	•	•••••	•••••

MoultrEX® Surface Options

Anti-Slip Surface (Standard)

This surface is most commonly used in industrial applications. It is very hard-wearing and has an extremely effective coefficient of friction (NATA laboratory test report available). Unlike serrated steel grating, the anti-slip surface does not impact on load carrying capacity.



Concave Surface

This is the preferred surface for environments where by-products are commonly caught by serrations, and is hence very often utilised in the food industry. This surface option can also be utilised for guarding options to allow safe handling/contact.



MoultrEX® Moultruded Fibreglass Grating

N
MTX-381025SR

Isometric View

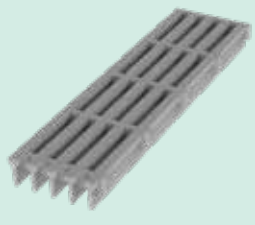

Plan View

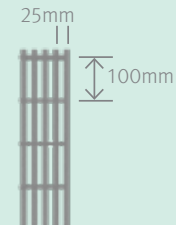

Elevation View

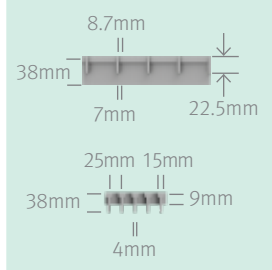



Safe Load & Deflection Charts (mm) - Uniform and Concentrated Line Loads

Mesh Grid	Load Bar Details	Span (mm)	Load Type	Uniform load – ΔU (kN/m²) – Deflection (mm) Concentrated line load – ΔC (kN/m) – Deflection (mm)															
				3	5	8	10	15	20	25	30	40	50	60	80	90	100		

MTX-381025SR																	
100x25	38x15 /22x8	200	ΔU	0.04	0.07	0.12	0.15	0.22	0.30	0.37	0.45	0.60	0.74	0.89	1.19	1.34	1.49
			ΔC	0.16	0.26	0.42	0.53	0.79	1.06	1.32	1.59	2.12	2.65	3.18	4.24	4.77	5.30
		400	ΔU	0.20	0.34	0.54	0.67	1.01	1.35	1.68	2.02	2.69	3.36	4.04	5.38	6.06	6.73
			ΔC	0.45	0.76	1.21	1.52	2.27	3.03	3.79	4.55	6.06	7.58	9.10	12.13	13.64	15.16
		600	ΔU	0.54	0.90	1.44	1.80	2.71	3.61	4.51	5.41	7.22	9.02	10.83	14.43	16.24	18.04
			ΔC	1.02	1.71	2.73	3.42	5.12	6.83	8.54	10.25						
		800	ΔU	1.18	1.97	3.14	3.93	5.90	7.86	9.83	11.79						
			ΔC	2.01	3.34	5.35	6.69	10.03									
		1000	ΔU	2.28	3.80	6.07	7.59	11.39									
			ΔC	3.53	5.89	9.43	11.78										
		1200	ΔU	4.05	6.74	10.79											
			ΔC	5.75	9.58												

EX-Series® Integral Kickplates

Treadwell sets the highest standards for grating kickplates without compromise. With the provision of high quality grating kickplates, Treadwell offers specifiers a flexibility in design and finishes, allowing projects that consistent finish that impresses. Each project is accurately cut before the required surface option is applied. This allows for an ultimate seamless finish that boasts quality and will endure. Rest assured of your design's longevity with Treadwell's high quality grating kickplates.

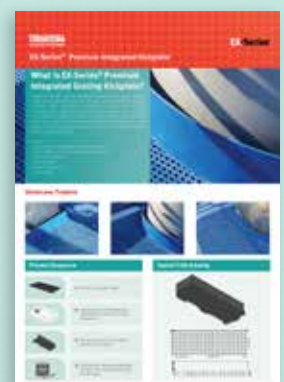

MoultrEX® Moultruded Fibreglass Grating

Treadwell stocks a range of durable 316 stainless steel secure clip options for MoultrEX® moultruded FRP grating. Further details regarding fixing types and ordering information can be found on page 96.

Clip - Tops

MoultrEX® M	3D	PLAN	ELEVATION	FASTENING OPTIONS
Hole Diameter: 6mm Material type: 316 st/st Threaded hole: N/A				2

Clamp Underside

Mini J Universal	G	U	V
Hole Diameter: N/A Material type: 316 st/st Threaded hole: N/A	Hole Diameter: 6mm Material type: st/st Threaded hole: Yes	Hole Diameter: 8mm Material type: 316 st/st Threaded hole: Yes	Hole Diameter: 8mm Material type: 316 st/st Threaded hole: N/A

Fixing Assembly Combinations

MJ Clip Assembly	MG Clip Assembly
<p>M5 Hex Head Set Screw</p> <p>MoultrEX® Type M Clip</p> <p>MoultrEX® Type Mini J Clip</p> <p>Lock Nut</p>	<p>M5 Hex Head Set Screw</p> <p>MoultrEX® Type M Clip</p> <p>MoultrEX® Type G Clip</p>
MU Clip Assembly	MV Clip Assembly
<p>M5 Hex Head Set Screw</p> <p>MoultrEX® Type M Clip</p> <p>GratEX® Type U Clip</p>	<p>M5 Socket Head Cap Screw</p> <p>MoultrEX® Type M Clip</p> <p>MoultrEX® Type MINI V Clip</p> <p>Lock Nut</p>

Please refer to Appendix 6b: MoultrEX® Fasteners Ordering Information (Page 96).

Not drawn to scale

MoultrEX® Moultruded Fibreglass Grating Specification

General

1.0 Scope

1.1 The grating shall conform to the material and fabrication requirements as per this specification.

2.0 Standards/Related documents

- 2.1 The grating system shall conform to the applicable sections of:
 - 2.1.1 ASTM E84 Surface Burning Characteristics of Building Materials
 - 2.1.2 ASTM D635 Rate of Burning and/or Extent and Time of Burning of Self-Supporting Plastics in a Horizontal Position.

3.0 Design Criteria

- 3.1 The design criteria of the fibreglass products (FRP) shall be in accordance with governing building codes and generally accepted standards in the FRP industry.
- 3.2 Design live loads shall be of ... kPa uniformly distributed load (or as per building code if more stringent) with a maximum deflection of ... mm at the centre of a single span according to product specifications.

4.0 Submittals

- 4.1 Shop drawings of all fabricated grating panels shall be submitted by Treadwell (unless provided by the client) displaying clearly material sizes, types, styles, product codes and including types and sizes of fasteners as well as a layout if required.
- 4.2 Technical data and sample pieces can also be submitted if required.

5.0 Quality Assurance

Quality surrounds every aspect of Treadwell's commitment to our superior products and efficiency. Treadwell's quality assurance strictly adheres to the high quality control standards placed to conform to relevant specifications, codes, Australian Standards and contractual requirements in a timely manner.

6.0 Product Delivery and Storage

- 6.1 All grating and components or ancillary items shall be fabricated as per the design and piece marked to design drawings.
- 6.2 All manufactured materials shall be delivered in unbroken packages.

Product System

7.0 Manufacturing Process

- 7.1 All fibreglass (FRP) items listed under this section shall be constructed from fibreglass reinforcement and resin of the quality necessary to meet the design requirements and dimensions as specified.
- 7.2 Fibreglass reinforcement shall be continuous roving and shall be in sufficient quantities as required for the application.
- 7.3 Resins shall be ... (refer to page 5) with chemical formulations as necessary to provide the corrosion resistance, strength and any other physical properties as required.
- 7.4 All finished surfaces to be smooth, resin-rich, free of voids and without dry spots, cracks or unreinforced areas and all fibreglass reinforcement shall be well covered with resin to protect against exposure due to weather or wear.
- 7.5 All fibreglass (FRP) items shall be EITHER non-fire retardant OR have a tested flame spread rating of 25 or less when tested in accordance with the ASTM E84 Tunnel Test.
- 7.6 Contact Treadwell regarding specification data relative to products conforming to ASTM D635.

- 7.7 All metal accessories shall be manufactured from (304 or 316) Stainless Steel, 2205 Duplex Stainless Steel, 2507 Super Duplex Stainless Steel, hot dipped galvanised steel or aluminium.
- 7.8 Load bars shall be joined with notched cross bars via interlocking methods and the use of chemical bonding.
- 7.9 The fibreglass reinforcement content shall be maintained at 65% (by weight) so as to achieve maximum loading capacity.
- 7.10 All fibreglass material shall have an ultraviolet light inhibiting chemical additive to resist UV degradation.
- 7.11 Grating shall be manufactured with a concave profile on top of each bar OR an anti-slip Aluminium Oxide surface to provide optimum slip resistance.

8.0 Acceptable Manufacturer

The fibreglass underfoot moulded grating system shall be manufactured by Treadwell Group Pty Ltd of Australia.

Ordering Information	Code
1. Nominate the type of grating required	MTX = MoultrEX® Moultruded Grating
Note: This section of the coding is typically separated from the next section of the coding by a dash (-)	
2. Nominate the depth (mm) required	38
3. Nominate the load bar centres required	1025 = 100mm X 25mm
4. Nominate the mesh type required	SR = Standard Rectangular Mesh
Note: This section of the coding is typically separated from the next section of the coding by a dash (-)	
5. Specify the resin, material or type (see page 6)	O = O-Series® I = I-Series® V = V-Series® P = P-Series®
6. Specify the colour required <small>*In which instance a code and name of the selected colour must be mentioned within the description.</small>	TY = Treadwell Yellow DG = Dark Grey LG = Light Grey TG = Treadwell Green CH = Charcoal CC = Custom Colour
7. Select the surface style required	G1 = Barefoot Grade (Grit) Anti-Slip G2 = Commercial Grade (Grit) Anti-Slip G3 = Industrial Grade (Grit) Anti-Slip G4 = Marine Grade (Grit) Anti-Slip CO = Concave PL = Plain (Smooth)
Note: The next section of coding is separated by a dash (-), it isn't required for custom jobs as MoultrEX® is available in a variety of size panels to suit applications.	
8. Nominate the panel size required	01 = 1200 mm x 3660 mm

Please refer to Appendix 4: MoultrEX® Ordering Codes - page 83

N Non-Stocked Item **C** Commonly Stocked Item

GridEX® Pultruded Fibreglass Grating

What is GridEX® Pultruded Fibreglass Grating

Treadwell's GridEX® pultruded FRP grating systems are designed for specific applications where a standard fibreglass grating system cannot be effectively be utilised. GridEX® offers you options such as selection of open space, bar shape, cross-rod placement, custom fabrication, and custom resin or colour.

A wide variety of bar shapes along with various bearing bar and cross-rod spacings are available depending on the design requirements. Refer to the safe load and deflection charts for our standard selection, and please do not hesitate to contact us for details relating to our custom options.

Most common GridEX® options are available in 25 mm, 38 mm and 50 mm depths. However, Treadwell brings to the market extremely heavy duty versions of GridEX® that offer more durable, stronger and much larger span capacities as the situation calls for.

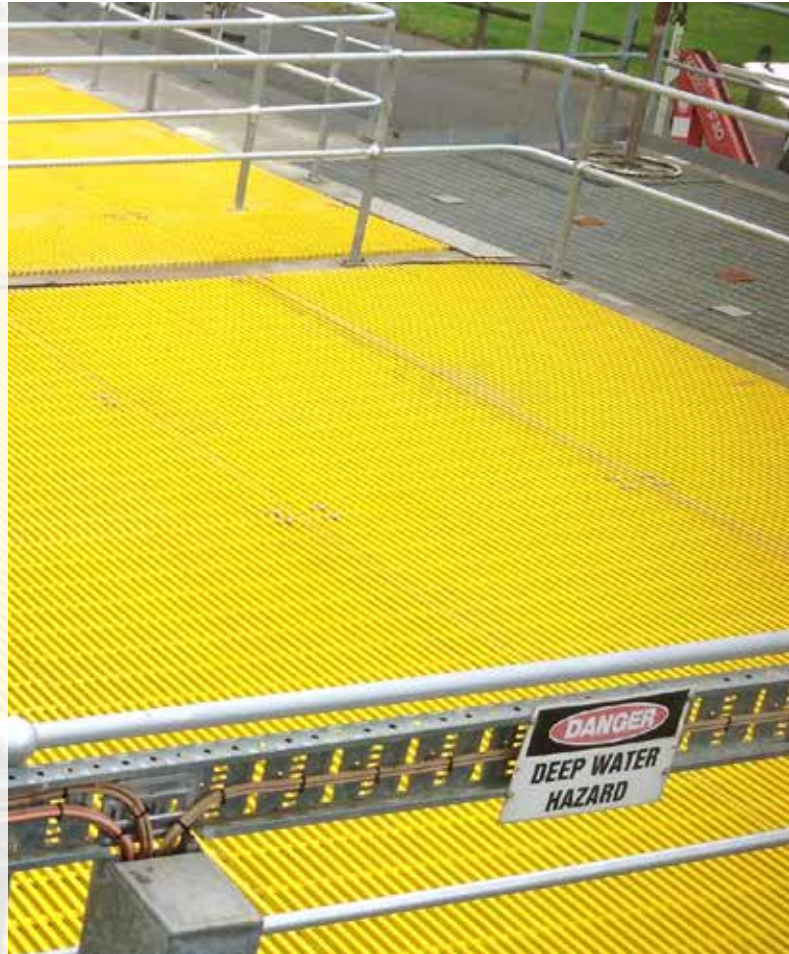

GridEX® Cross Rod Systems

Treadwell is the only company to offer numerous cross rod systems, allowing you the flexibility to achieve what is required for your application.



Standard (Two Part)



Heavy Duty (Three Part)

GridEX® Surface Options

Ribbed Surface

This is the preferred surface for environments where by-products are commonly caught by serrations, and is hence very often utilised in the food industry. This surface option can also be utilised for wet areas and wash down applications.



Anti-Slip Surface (Standard)

A very hard-wearing surface with an extremely effective coefficient of friction (NATA laboratory test report available) – commonly used in industrial applications. Unlike serrated steel grating, the anti-slip surface does not impact load carrying capacity.



Covered Surface

This non-stock option is very often utilised for applications where high strength covered floors are required. The system is supplied with Checkerplate or Anti-Slip surface bonded to every load bar to ensure performance is maintained in harsh environments.



GridEX® I Type Grating

GDX-251510IB

N

Isometric View

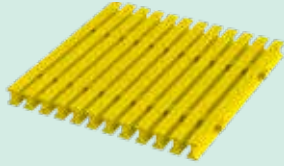

Plan View

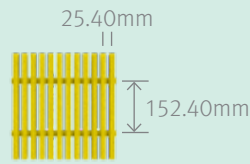

Elevation View

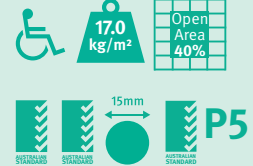
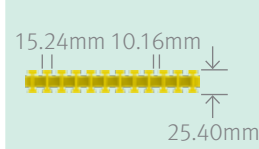

GDX-251515IB

N

Isometric View

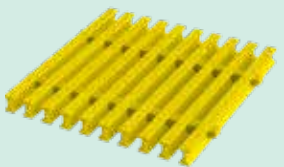

Plan View

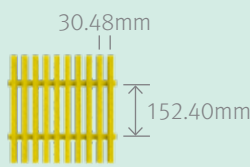

Elevation View

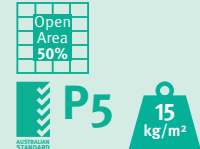
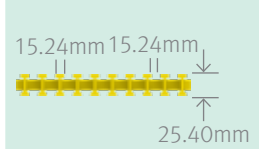

GDX-251523IB

N

Isometric View

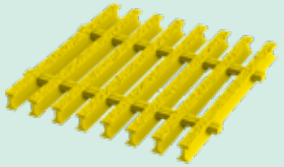

Plan View

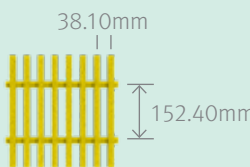

Elevation View

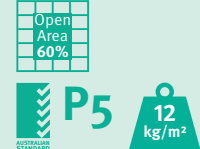
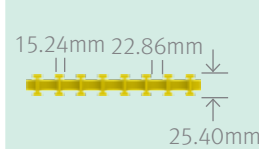

RailEX® FRP Handrail

The RailEX® FRP handrail system is a patented industrial rated product that is noted for its durability, strength, and versatility. Further, Treadwell's FRP handrail system has multiple uses in many industries and markets, and can be tailored to meet the requirements of our clients. Treadwell can deliver RailEX® as components or as prefabricated systems for immediate installation.

Treadwell's FRP handrails are available both in square and round configurations.



GridEX® I Type Grating

GDX-381510IB N

<p>Isometric View</p>	<p>Plan View</p>	<p>Elevation View</p>	
-----------------------	------------------	-----------------------	--

GDX-381515IB N

<p>Isometric View</p>	<p>Plan View</p>	<p>Elevation View</p>	
-----------------------	------------------	-----------------------	--

GDX-381523IB N

<p>Isometric View</p>	<p>Plan View</p>	<p>Elevation View</p>	
-----------------------	------------------	-----------------------	--

GDX-500805IB N

<p>Isometric View</p>	<p>Plan View</p>	<p>Elevation View</p>	
-----------------------	------------------	-----------------------	--

GDX-760805IB N

<p>Isometric View</p>	<p>Plan View</p>	<p>Elevation View</p>	
-----------------------	------------------	-----------------------	--

Safe Load & Deflection Charts (mm) - Uniform and Concentrated Line Loads

Grid			Span mm	Load Type	Uniform load – ΔU (kN/m²) – Deflection (mm) Concentrated line load – ΔC (kN/m) – Deflection (mm)														
Open	Closed	Depth			3	5	8	10	15	20	25	30	40	50	60	80	90	100	
GDX-251510IB																			
40%	60%	25mm	400	ΔU	0.06	0.11	0.17	0.22	0.32	0.43	0.54	0.65	0.86	1.08	1.30	1.73	1.94	2.16	
				ΔC	0.25	0.41	0.65	0.82	1.23	1.63	2.04	2.45	3.27	4.09	4.90	6.54	7.35	8.17	
			600	ΔU	0.27	0.45	0.71	0.89	1.34	1.79	2.23	2.68	3.57	4.47	5.36	7.15	8.04	8.93	
				ΔC	0.70	1.17	1.87	2.33	3.50	4.66	5.83	7.00	9.33	11.66	13.99				
			800	ΔU	0.78	1.30	2.08	2.60	3.91	5.21	6.51	7.81	10.41	13.02					
				ΔC	1.55	2.59	4.14	5.17	7.76	10.35	12.93								
			1000	ΔU	1.83	3.05	4.89	6.11	9.16	12.21									
				ΔC	2.94	4.89	7.83	9.79	14.68										
			1200	ΔU	3.72	6.19	9.91	12.38											
				ΔC	4.98	8.31	13.29												
			1400	ΔU	6.79	11.31													
				ΔC	7.83	13.05													

GDX-251523IB																			
60%	40%	25mm	400	ΔU	0.09	0.16	0.25	0.31	0.47	0.63	0.79	0.94	1.26	1.57	1.89	2.52	2.83	3.14	
				ΔC	0.36	0.61	0.97	1.22	1.82	2.43	3.04	3.65	4.86	6.08	7.29	9.73	10.94	12.16	
			600	ΔU	0.40	0.66	1.06	1.33	1.99	2.65	3.31	3.98	5.30	6.63	7.95	10.60	11.93	13.25	
				ΔC	1.04	1.74	2.79	3.48	5.22	6.97	8.71	10.45	13.93						
			800	ΔU	1.17	1.95	3.11	3.89	5.84	7.79	9.73	11.68	15.57						
				ΔC	2.32	3.87	6.19	7.74	11.61	15.48									
			1000	ΔU	2.75	4.59	7.34	9.17	13.76										
				ΔC	4.40	7.33	11.72	14.66											
			1200	ΔU	5.59	9.32	14.91												
				ΔC	7.47	12.44													
			1400	ΔU	10.23														
				ΔC	11.73														



Anti-Slip Testing & Compliance

EX-Series® grating can be designed and supplied compliant to anti-slip wet and dry resistance as outlined in AS 4586-2013.

Treadwell’s anti-slip grating properties can reduce onsite slip and trip injuries. FRP grating has a higher slip resistance when compared to metal, wood or concrete tiled surfaces.

GridEX® I Type Grating

Grid			Span mm	Load Type	Uniform load – ΔU (kN/m ²) – Deflection (mm) Concentrated line load – ΔC (kN/m) – Deflection (mm)															
Open	Closed	Depth			3	5	8	10	15	20	25	30	40	50	60	80	90	100		
GDX-381510IB																				
40%	60%	38mm	400	ΔU	0.02	0.04	0.06	0.07	0.11	0.14	0.18	0.22	0.29	0.36	0.43	0.58	0.65	0.72		
				ΔC	0.02	0.03	0.05	0.06	0.09	0.12	0.15	0.18	0.24	0.30	0.36	0.48	0.54	0.60		
			600	ΔU	0.10	0.16	0.26	0.32	0.48	0.64	0.80	0.96	1.28	1.60	1.92	2.56	2.88	3.20		
				ΔC	0.18	0.30	0.47	0.59	0.89	1.18	1.48	1.77	2.36	2.95	3.54	4.72	5.31	5.90		
			800	ΔU	0.29	0.48	0.77	0.96	1.44	1.92	2.41	2.89	3.85	4.81	5.77	7.70	8.66	9.62		
				ΔC	0.52	0.86	1.38	1.72	2.58	3.44	4.30	5.16	6.88	8.60	10.32	13.76	15.48			
			1000	ΔU	0.69	1.15	1.84	2.29	3.44	4.59	5.73	6.88	9.18	11.47	13.76					
				ΔC	1.09	1.82	2.92	3.65	5.47	7.30	9.12	10.95	14.60							
			1200	ΔU	1.41	2.35	3.76	4.69	7.04	9.39	11.74	14.08								
				ΔC	1.97	3.29	5.26	6.58	9.87	13.16										
			1400	ΔU	2.59	4.31	6.90	8.63	12.94											
				ΔC	3.21	5.35	8.57	10.71												
			1600	ΔU	4.39	7.32	11.71													
				ΔC	4.87	8.12	12.99													

GDX-500805IB																				
40%	60%	50mm	400	ΔU	0.01	0.01	0.02	0.02	0.03	0.04	0.05	0.06	0.08	0.10	0.12	0.16	0.18	0.20		
				ΔC	0.03	0.04	0.07	0.09	0.13	0.17	0.21	0.26	0.34	0.43	0.51	0.68	0.77	0.85		
			600	ΔU	0.04	0.06	0.09	0.12	0.18	0.23	0.29	0.35	0.47	0.59	0.70	0.94	1.06	1.17		
				ΔC	0.08	0.13	0.21	0.26	0.39	0.51	0.64	0.77	1.03	1.28	1.54	2.05	2.31	2.57		
			800	ΔU	0.12	0.20	0.31	0.39	0.59	0.78	0.98	1.17	1.56	1.95	2.34	3.12	3.52	3.91		
				ΔC	0.18	0.29	0.47	0.58	0.88	1.17	1.46	1.75	2.33	2.92	3.50	4.67	5.25	5.84		
			1000	ΔU	0.29	0.49	0.78	0.98	1.46	1.95	2.44	2.93	3.91	4.88	5.86	7.81	8.79	9.76		
				ΔC	0.34	0.56	0.89	1.12	1.68	2.23	2.79	3.35	4.47	5.59	6.70	8.94	10.06	11.17		
			1200	ΔU	0.62	1.03	1.64	2.05	3.08	4.10	5.13	6.15	8.20	10.25	12.30					
				ΔC	0.57	0.95	1.53	1.91	2.86	3.82	4.77	5.73	7.64	9.55	11.46					
			1400	ΔU	1.15	1.91	3.06	3.83	5.74	7.65	9.57	11.48								
				ΔC	0.90	1.51	2.41	3.01	4.52	6.02	7.53	9.03	12.05							
			1600	ΔU	1.97	3.28	5.25	6.56	9.84	13.12										
				ΔC	1.34	2.24	3.58	4.48	6.71	8.95	11.19	13.43								
			1800	ΔU	3.16	5.27	8.43	10.54	15.81	21.08										
				ΔC	1.91	3.18	5.08	6.35	9.53	12.71	15.88	19.06								
			2000	ΔU	4.83	8.05	12.88	16.10	24.16											
				ΔC	2.61	4.35	6.96	8.70	13.04	17.39	21.74									

GridEX® I Type Specification

General

1.0 Scope

- 1.1 The grating shall conform to the material and fabrication requirements as per this specification.

2.0 Standards/Related documents

- 2.1 The grating system shall conform to the applicable sections of:
- 2.1.1 ASTM E84 Surface Burning Characteristics of Building Materials
 - 2.1.2 ASTM D635 Rate of Burning and/or Extent and Time of Burning of Self-Supporting Plastics in a Horizontal Position.

3.0 Design Criteria

- 3.1 The design criteria of the fibreglass products (FRP) shall be in accordance with governing building codes and generally accepted standards in the FRP industry.
- 3.2 Design live loads shall be of ... kPa uniformly distributed load (or as per building code if more stringent) with a maximum deflection of ... mm at the centre of a single span according to product specifications.

4.0 Submittals

- 4.1 Shop drawings of all fabricated grating panels shall be submitted by Treadwell (unless provided by the client) displaying clearly material sizes, types, styles, product codes and including types and sizes of fasteners as well as a layout if required.
- 4.2 Technical data and sample pieces can also be submitted if required.

5.0 Quality Assurance

Quality surrounds every aspect of Treadwell's commitment to our superior products and efficiency. Treadwell's quality assurance strictly adheres to the high quality control standards placed to conform to relevant specifications, codes, Australian Standards and contractual requirements in a timely manner.

6.0 Product Delivery and Storage

- 6.1 All grating and components or ancillary items shall be fabricated as per the design and piece marked to design drawings.
- 6.2 All manufactured materials shall be delivered in unbroken packages.

Product System

7.0 Manufacturing Process

- 7.1 All fibreglass (FRP) items listed under this section shall be constructed from fibreglass reinforcement and resin of the quality necessary to meet the design requirements and dimensions as specified.
- 7.2 Fibreglass reinforcement shall be continuous roving and shall be in sufficient quantities as required for the application.
- 7.3 Resins shall be ... (refer to page 5) with chemical formulations as necessary to provide the corrosion resistance, strength and any other physical properties as required.
- 7.4 All finished surfaces to be smooth, resin-rich, free of voids and without dry spots, cracks or unreinforced areas and all fibreglass reinforcement shall be well covered with resin to protect against exposure due to weather or wear.
- 7.5 All fibreglass (FRP) items shall be EITHER non-fire retardant OR have a tested flame spread rating of 25 or less when tested in accordance with the ASTM E84 Tunnel Test.
- 7.6 Contact Treadwell regarding specification data relative to products conforming to ASTM D635.
- 7.7 All metal accessories shall be manufactured from (304 or 316) Stainless Steel, 2205 Duplex Stainless Steel, 2507 Super Duplex Stainless Steel,

hot dipped galvanised steel or aluminium.

- 7.8 Load bars shall be joined with notched cross bars via interlocking methods and the use of chemical bonding.
- 7.9 The fibreglass reinforcement content shall be maintained at 65% (by weight) so as to achieve maximum loading capacity.
- 7.10 All fibreglass material shall have an ultraviolet light inhibiting chemical additive to resist UV degradation.
- 7.11 Grating shall be manufactured with a concave profile on top of each bar OR an anti-slip Aluminium Oxide surface to provide optimum slip resistance.

8.0 Acceptable Manufacturer

The fibreglass underfoot moulded grating system shall be manufactured by Treadwell Group Pty Ltd of Australia.

Ordering Information

Code



1. Nominate the type of grating required	GD X = GridEX® Pultruded Grating
Note: This section of the coding is typically separated from the next section of the coding by a dash (-)	
2. Nominate the depth (mm) required	25, 38, 50 and 76
3. Nominate the load bar centres required	1510 = 15mm bar width and 10mm space 1515 = 15mm bar width and 15mm space 1523 = 15mm bar width and 22.9mm space 0805 = 7.9mm bar width and 5.3mm space
4. Nominate the mesh type required	IB = I Type
Note: This section of the coding is typically separated from the next section of the coding by a dash (-)	
5. Specify the resin, material or type (see page 6)	I = I-Series® V = V-Series® P = P-Series®
6. Specify the colour required <small>*In which instance a code and name of the selected colour must be mentioned within the description.</small>	TY = Treadwell Yellow DG = Dark Grey LG = Light Grey TG = Treadwell Green CH = Charcoal CC = Custom Colour
7. Specify the surface style required	G1 = Barefoot Grade (Grit) Anti-Slip G2 = Commercial Grade (Grit) Anti-Slip G3 = Industrial Grade (Grit) Anti-Slip G4 = Marine Grade (Grit) Anti-Slip PL = Plain (Smooth) CV = Covered RB = Ribbed
Note: The next section of coding is separated by a dash (-), it isn't required for custom jobs as GridEX® is available in a variety of size panels to suit applications.	
8. Nominate the panel size required	01 = 1200 mm x 5800 mm

Please refer to Appendix 5: GridEX® Ordering Codes - page 84

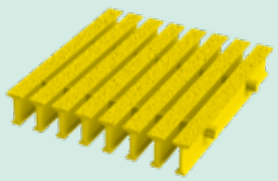
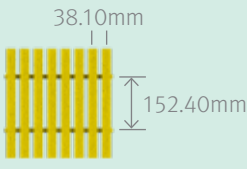
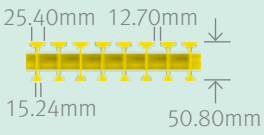

N Non-Stocked Item **C** Commonly Stocked Item

GridEX® T Type Grating

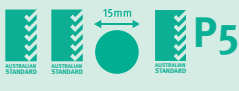
GDX-502513TB N

<p>Isometric View</p> 	<p>Plan View</p> 	<p>Elevation View</p> 	 <p>21.66 kg/m²</p> <p>Open Area 33%</p> 
---	--	--	--

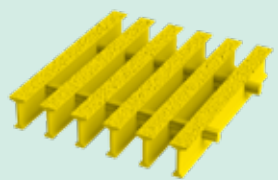
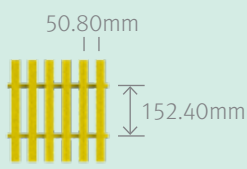
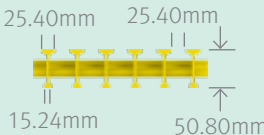
GDX-502525TB N

<p>Isometric View</p> 	<p>Plan View</p> 	<p>Elevation View</p> 	 <p>16.80 kg/m²</p> <p>Open Area 50%</p> 
--	---	---	--

ArchitEX™ FRP Structural Profiles

The Treadwell team is delighted to introduce ArchitEX™, our structural range of FRP profiles. Serving as the ultimate tool for designing FRP structures, the data in this structural product guide has been collated to ensure that engineers and architects have the ideal reference available to them while designing structures for highly corrosive applications.

Treadwell has also made data from the guide available through our TreadSpec® online selection tool, which allows users to fill in selection criteria in order to obtain relevant load & deflection information making for simpler and easier design of FRP structures.



GridEX® T Type Grating

Safe Load & Deflection Charts (mm) - Uniform and Concentrated Line Loads

Grid			Span mm	Load Type	Uniform load – ΔU (kN/m²) – Deflection (mm) Concentrated line load – ΔC (kN/m) – Deflection (mm)													
Open	Closed	Depth			3	5	8	10	15	20	25	30	40	50	60	80	90	100

GDX-502513TB																		
33%	67%	50mm	400	ΔU	0.03	0.05	0.07	0.09	0.14	0.19	0.23	0.28	0.37	0.47	0.56	0.74	0.84	0.93
				ΔC	0.14	0.23	0.37	0.46	0.68	0.91	1.14	1.37	1.83	2.28	2.74	3.65	4.11	4.56
			600	ΔU	0.09	0.15	0.24	0.30	0.45	0.60	0.75	0.90	1.21	1.51	1.81	2.41	2.71	3.02
				ΔC	0.28	0.46	0.73	0.92	1.38	1.84	2.29	2.75	3.67	4.59	5.51	7.34	8.26	9.18
			800	ΔU	0.23	0.38	0.61	0.77	1.15	1.53	1.92	2.30	3.06	3.83	4.60	6.13	6.89	7.66
				ΔC	0.50	0.83	1.33	1.66	2.49	3.32	4.15	4.98	6.63	8.29	9.95	13.27	14.93	16.58
			1000	ΔU	0.50	0.83	1.33	1.66	2.49	3.32	4.15	4.98	6.64	8.29	9.95	13.27	14.93	
				ΔC	0.83	1.39	2.22	2.77	4.16	5.54	6.93	8.32	11.09	13.86	16.63			
			1200	ΔU	0.96	1.60	2.56	3.20	4.80	6.40	8.00	9.60	12.81	16.01				
				ΔC	1.31	2.18	3.48	4.35	6.53	8.70	10.88	13.05						
			1400	ΔU	1.70	2.83	4.53	5.66	8.50	11.33	14.16							
				ΔC	1.95	3.25	5.19	6.49	9.74	12.98								
			1600	ΔU	2.81	4.68	7.49	9.37	14.05									
				ΔC	2.78	4.64	7.43	9.28	13.92									
			1800	ΔU	4.40	7.34	11.75	14.68										
				ΔC	3.85	6.41	10.25	12.82										

GDX-502525TB																		
50%	50%	50mm	400	ΔU	0.02	0.04	0.06	0.08	0.12	0.16	0.20	0.24	0.32	0.41	0.49	0.65	0.73	0.81
				ΔC	0.10	0.17	0.28	0.35	0.52	0.69	0.87	1.04	1.39	1.74	2.08	2.78	3.12	3.47
			600	ΔU	0.09	0.16	0.25	0.31	0.47	0.63	0.79	0.94	1.26	1.57	1.89	2.52	2.83	3.14
				ΔC	0.26	0.43	0.70	0.87	1.30	1.74	2.17	2.61	3.48	4.35	5.22	6.96	7.83	8.70
			800	ΔU	0.27	0.44	0.71	0.89	1.33	1.78	2.22	2.66	3.55	4.44	5.33	7.10	7.99	8.88
				ΔC	0.54	0.91	1.45	1.81	2.72	3.62	4.53	5.43	7.25	9.06	10.87	14.49		
			1000	ΔU	0.61	1.02	1.64	2.05	3.07	4.09	5.12	6.14	8.19	10.24	12.28			
				ΔC	0.99	1.66	2.65	3.31	4.97	6.62	8.28	9.94	13.25					
			1200	ΔU	1.23	2.06	3.29	4.11	6.17	8.22	10.28	12.33						
				ΔC	1.65	2.76	4.41	5.51	8.27	11.02	13.78							
			1400	ΔU	2.24	3.73	5.97	7.46	11.20	14.93								
				ΔC	2.56	4.27	6.84	8.55	12.82									
			1600	ΔU	3.77	6.28	10.05	12.57										
				ΔC	3.77	6.28	10.05	12.56										
			1800	ΔU	5.98	9.97	15.96											
				ΔC	5.31	8.85	14.15											

GridEX® T Type Specification

General

1.0 Scope

1.1 The grating shall conform to the material and fabrication requirements as per this specification.

2.0 Standards/Related documents

- 2.1 The grating system shall conform to the applicable sections of:
- 2.1.1 ASTM E84 Surface Burning Characteristics of Building Materials
 - 2.1.2 ASTM D635 Rate of Burning and/or Extent and Time of Burning of Self-Supporting Plastics in a Horizontal Position.

3.0 Design Criteria

- 3.1 The design criteria of the fibreglass products (FRP) shall be in accordance with governing building codes and generally accepted standards in the FRP industry.
- 3.2 Design live loads shall be of ... kPa uniformly distributed load (or as per building code if more stringent) with a maximum deflection of ... mm at the centre of a single span according to product specifications.

4.0 Submittals

- 4.1 Shop drawings of all fabricated grating panels shall be submitted by Treadwell (unless provided by the client) displaying clearly material sizes, types, styles, product codes and including types and sizes of fasteners as well as a layout if required.
- 4.2 Technical data and sample pieces can also be submitted if required.

5.0 Quality Assurance

Quality surrounds every aspect of Treadwell's commitment to our superior products and efficiency. Treadwell's quality assurance strictly adheres to the high quality control standards placed to conform to relevant specifications, codes, Australian Standards and contractual requirements in a timely manner.

6.0 Product Delivery and Storage

- 6.1 All grating and components or ancillary items shall be fabricated as per the design and piece marked to design drawings.
- 6.2 All manufactured materials shall be delivered in unbroken packages.

Product System

7.0 Manufacturing Process

- 7.1 All fibreglass (FRP) items listed under this section shall be constructed from fibreglass reinforcement and resin of the quality necessary to meet the design requirements and dimensions as specified.
- 7.2 Fibreglass reinforcement shall be continuous roving and shall be in sufficient quantities as required for the application.
- 7.3 Resins shall be ... (refer to page 5) with chemical formulations as necessary to provide the corrosion resistance, strength and any other physical properties as required.
- 7.4 All finished surfaces to be smooth, resin-rich, free of voids and without dry spots, cracks or unreinforced areas and all fibreglass reinforcement shall be well covered with resin to protect against exposure due to weather or wear.
- 7.5 All fibreglass (FRP) items shall be EITHER non-fire retardant OR have a tested flame spread rating of 25 or less when tested in accordance with the ASTM E84 Tunnel Test.
- 7.6 Contact Treadwell regarding specification data relative to products conforming to ASTM D635.

- 7.7 All metal accessories shall be manufactured from (304 or 316) Stainless Steel, 2205 Duplex Stainless Steel, 2507 Super Duplex Stainless Steel, hot dipped galvanised steel or aluminium.
- 7.8 Load bars shall be joined with notched cross bars via interlocking methods and the use of chemical bonding.
- 7.9 The fibreglass reinforcement content shall be maintained at 65% (by weight) so as to achieve maximum loading capacity.
- 7.10 All fibreglass material shall have an ultraviolet light inhibiting chemical additive to resist UV degradation.
- 7.11 Grating shall be manufactured with a concave profile on top of each bar OR an anti-slip Aluminium Oxide surface to provide optimum slip resistance.

8.0 Acceptable Manufacturer

The fibreglass underfoot moulded grating system shall be manufactured by Treadwell Group Pty Ltd of Australia.

Ordering Information

Code

- | | |
|---|---------------------------------|
| 1. Nominate the type of grating required | GDX = GridEX® Pultruded Grating |
| Note: This section of the coding is typically separated from the next section of the coding by a dash (-) | |

- | | |
|---|--|
| 2. Nominate the depth (mm) required | 50 |
| 3. Nominate the load bar centres required | 2513 = 25mm bar width and 12.7mm space
2525 = 25mm bar width and 25mm space |
| 4. Nominate the mesh type required | TB = T Type |

Note: This section of the coding is typically separated from the next section of the coding by a dash (-)

- | | |
|--|--|
| 5. Specify the resin, material or type (see page 6) | I = I-Series®
V = V-Series®
P = P-Series® |
| 6. Specify the colour required
<small>*In which instance a code and name of the selected colour must be mentioned within the description.</small> | TY = Treadwell Yellow
DG = Dark Grey
LG = Light Grey
TG = Treadwell Green
CH = Charcoal
CC = Custom Colour |
| 7. Specify the surface style required | G1 = Barefoot Grade (Grit) Anti-Slip
G2 = Commercial Grade (Grit) Anti-Slip
G3 = Industrial Grade (Grit) Anti-Slip
G4 = Marine Grade (Grit) Anti-Slip
PL = Plain (Smooth)
CV = Covered
RB = Ribbed |

Note: The next section of coding is separated by a dash (-), it isn't required for custom jobs as GridEX® is available in a variety of size panels to suit applications.

- | | |
|-------------------------------------|------------------------|
| 8. Nominate the panel size required | 01 = 1200 mm x 5800 mm |
|-------------------------------------|------------------------|

Please refer to Appendix 5: GridEX® Ordering Codes - page 84

N Non-Stocked Item **C** Commonly Stocked Item

GridEX® Bar Type Grating

GDX-501510BB N

Isometric View

Plan View

Elevation View

57.60 kg/m²

Open Area
40%

GDX-501515BB N

Isometric View

Plan View

Elevation View

Open Area
50%

48.40 kg/m²

GDX-501523BB N

Isometric View

Plan View

Elevation View

Open Area
60%

39.20 kg/m²



SAFE-SERIES™ Anti-Slip Products

SAFE-SERIES™ is Treadwell's selection of pre-manufactured and ready made for installation anti-slip products for harsh environments. Fabricated from FRP composites, anti-slip stair nosings, deck plating and rung covers are easy to install over existing stairs to create the toughest and most dependable anti-slip surface available.

The SAFE-SERIES™ product range offers a wide range of anti-slip solutions which can be used in numerous applications (proven in many applications). The series is available in various styles and colours to suit any environment.

GridEX® Bar Type Specification

General

1.0 Scope

1.1 The grating shall conform to the material and fabrication requirements as per this specification.

2.0 Standards/Related documents

- 2.1 The grating system shall conform to the applicable sections of:
- 2.1.1 ASTM E84 Surface Burning Characteristics of Building Materials
 - 2.1.2 ASTM D635 Rate of Burning and/or Extent and Time of Burning of Self-Supporting Plastics in a Horizontal Position.

3.0 Design Criteria

- 3.1 The design criteria of the fibreglass products (FRP) shall be in accordance with governing building codes and generally accepted standards in the FRP industry.
- 3.2 Design live loads shall be of ... kPa uniformly distributed load (or as per building code if more stringent) with a maximum deflection of ... mm at the centre of a single span according to product specifications.

4.0 Submittals

- 4.1 Shop drawings of all fabricated grating panels shall be submitted by Treadwell (unless provided by the client) displaying clearly material sizes, types, styles, product codes and including types and sizes of fasteners as well as a layout if required.
- 4.2 Technical data and sample pieces can also be submitted if required.

5.0 Quality Assurance

Quality surrounds every aspect of Treadwell's commitment to our superior products and efficiency. Treadwell's quality assurance strictly adheres to the high quality control standards placed to conform to relevant specifications, codes, Australian Standards and contractual requirements in a timely manner.

6.0 Product Delivery and Storage

- 6.1 All grating and components or ancillary items shall be fabricated as per the design and piece marked to design drawings.
- 6.2 All manufactured materials shall be delivered in unbroken packages.

Product System

7.0 Manufacturing Process

- 7.1 All fibreglass (FRP) items listed under this section shall be constructed from fibreglass reinforcement and resin of the quality necessary to meet the design requirements and dimensions as specified.
- 7.2 Fibreglass reinforcement shall be continuous roving and shall be in sufficient quantities as required for the application.
- 7.3 Resins shall be ... (refer to page 5) with chemical formulations as necessary to provide the corrosion resistance, strength and any other physical properties as required.
- 7.4 All finished surfaces to be smooth, resin-rich, free of voids and without dry spots, cracks or unreinforced areas and all fibreglass reinforcement shall be well covered with resin to protect against exposure due to weather or wear.
- 7.5 All fibreglass (FRP) items shall be EITHER non-fire retardant OR have a tested flame spread rating of 25 or less when tested in accordance with the ASTM E84 Tunnel Test.
- 7.6 Contact Treadwell regarding specification data relative to products conforming to ASTM D635.

- 7.7 All metal accessories shall be manufactured from (304 or 316) Stainless Steel, 2205 Duplex Stainless Steel, 2507 Super Duplex Stainless Steel, hot dipped galvanised steel or aluminium.
- 7.8 Load bars shall be joined with notched cross bars via interlocking methods and the use of chemical bonding.
- 7.9 The fibreglass reinforcement content shall be maintained at 65% (by weight) so as to achieve maximum loading capacity.
- 7.10 All fibreglass material shall have an ultraviolet light inhibiting chemical additive to resist UV degradation.
- 7.11 Grating shall be manufactured with a concave profile on top of each bar OR an anti-slip Aluminium Oxide surface to provide optimum slip resistance.

8.0 Acceptable Manufacturer

The fibreglass underfoot moulded grating system shall be manufactured by Treadwell Group Pty Ltd of Australia.

Ordering Information

Code

1. Nominate the type of grating required	GD \times = GridEX® Pultruded Grating
Note: This section of the coding is typically separated from the next section of the coding by a dash (-)	
2. Nominate the depth (mm) required	50
3. Nominate the load bar centres required	1510 = 15mm bar width and 10mm space 1515 = 15mm bar width and 15mm space 1523 = 15mm bar width and 22.9mm space
4. Nominate the mesh type required	BB = Bar Type
Note: This section of the coding is typically separated from the next section of the coding by a dash (-)	
5. Specify the resin, material or type (see page 6)	I = I-Series® V = V-Series® P = P-Series®
6. Specify the colour required	TY = Treadwell Yellow DG = Dark Grey LG = Light Grey TG = Treadwell Green CH = Charcoal CC = Custom Colour
*In which instance a code and name of the selected colour must be mentioned within the description.	
7. Specify the surface style required	G1 = Barefoot Grade (Grit) Anti-Slip G2 = Commercial Grade (Grit) Anti-Slip G3 = Industrial Grade (Grit) Anti-Slip G4 = Marine Grade (Grit) Anti-Slip PL = Plain (Smooth) CV = Covered RB = Ribbed
Note: The next section of coding is separated by a dash (-), it isn't required for custom jobs as GridEX® is available in a variety of size panels to suit applications.	
8. Nominate the panel size required	O1 = 1200 mm x 5800 mm

Please refer to Appendix 5: GridEX® Ordering Codes - page 84

N Non-Stocked Item **C** Commonly Stocked Item

GridEX® Stair Treads



Treadwell's range of GridEX® Stair Treads includes both open surface and closed surface options, with a range of surface patterns, colour and leading edge nosing options.

GridEX® Stair Treads are normally implemented in applications where there are greater load bearing and strength capacities required that other grating variations cannot offer. The GridEX® Treads are available in all bar types and dimensional variations.

All GridEX® Premium and Standard Stair Tread options are moulded with the Solid Leading Edge Nosing as an integrated single stage operation. This increases the rigidity and durability of the entire leading edge, ensuring reliable performance in high traffic scenarios. All the treads with abrasive leading edge nosings are manufactured to conform with AS 1657 – 2018.

The GridEX® Stair Tread nosings (premium treads only) are typically stocked in colours that contrast by 30% with the primary tread colour. This ensures maximum visual awareness of the stair treads forward edge for operators utilising the stairways and consequently enhancing the OHS safety ratings.

Treadwell recommends that leading edge nosings are specified when ordering GridEX® Stair Treads as the safety risks associated with elevated work areas or walkways is significantly increased without them.

NOTE: A bearing surface of at least 40mm is recommended at either side of GridEX® Stair Treads. Compliance with AS 1657 – 2018 requires a tread depth of less than 225mm.

Selecting a tread with lasting non-slip properties, resilience to corrosion and proven long term cost advantages can help you enhance safety in the workplace by reducing the chance of slips, trips and falls.

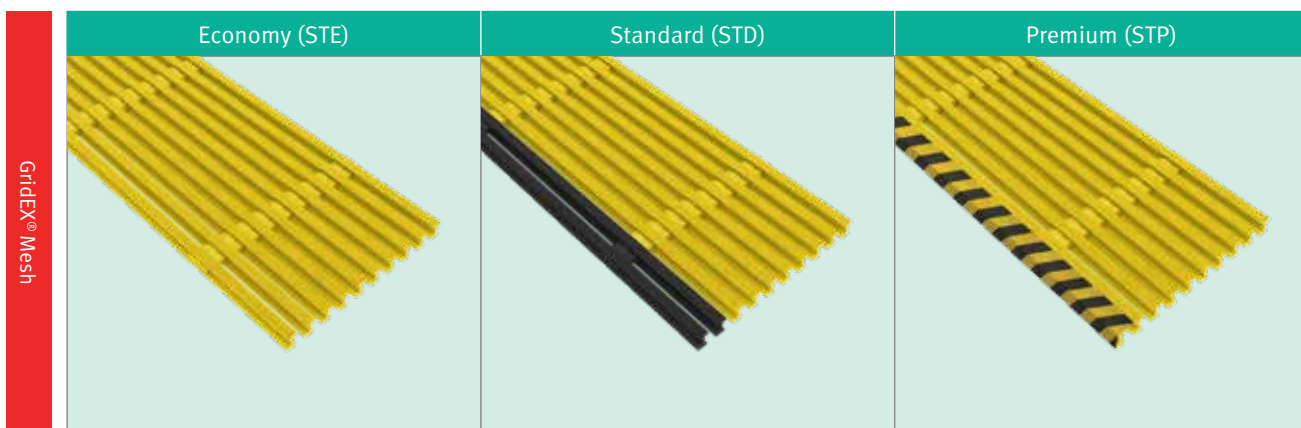

Benefits of FRP



Virtually Maintenance Free



Given the nature of FRP, any system utilising it is virtually maintenance free, thus keeping maintenance costs as low as possible.

GridEX® Installation Methods & Accessories

Treadwell stocks a range of durable 316 stainless steel secure clip options for GridEX® pultruded FRP grating. Further details regarding fixing types and ordering information can be found on page 97.

For apertures between each load bar which are less than 15mm, the GridEX® M clip with the 6mm hole diameter is recommended. For 15mm and above, the GridEX® M clip with the 8mm hole diameter is recommended.

Clip - Tops

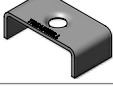
ITEM	PROFILES	HOLE DIAMETER	MATERIAL TYPE	THREADED HOLE	FASTENING OPTIONS
GridEX® M clip for 50% open grating		8mm	316 st/st	N/A	1
GridEX® M clip for 60% open grating		8mm	316 st/st	N/A	1
GridEX® N clip		8mm	316 st/st	N/A	1

Clamp Underside

Mini J Universal	G	U	V	H
				
Hole Diameter: N/A Material type: 316 st/st Threaded hole: N/A	Hole Diameter: 8mm Material type: st/st Threaded hole: Yes	Hole Diameter: 8mm Material type: 316 st/st Threaded hole: Yes	Hole Diameter: 8mm Material type: 316 st/st Threaded hole: N/A	Hole Diameter: 8mm Material type: st/st Threaded hole: Yes

Fixing Assembly Combinations

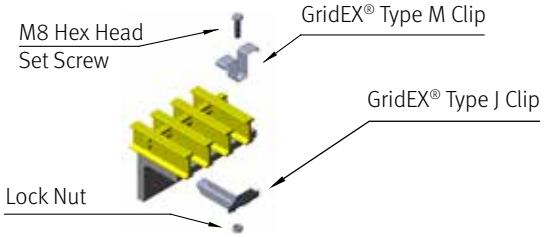
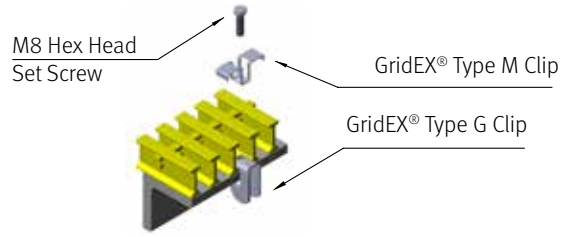
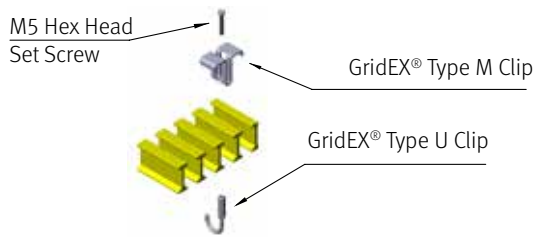
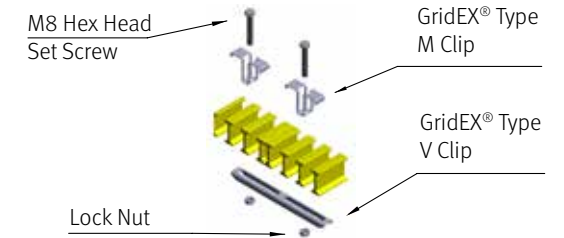
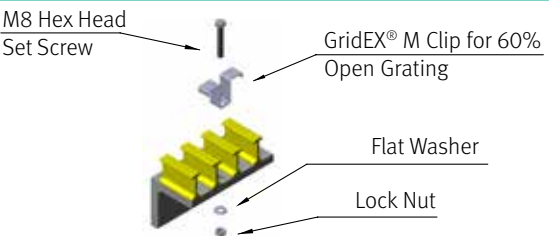
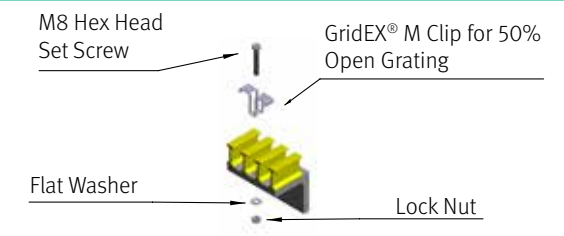
<p>MJ Clip Assembly</p>  <p>M8 Hex Head Set Screw</p> <p>GridEX® Type M Clip</p> <p>GridEX® Type J Clip</p> <p>Lock Nut</p>	<p>MG Clip Assembly</p>  <p>M8 Hex Head Set Screw</p> <p>GridEX® Type M Clip</p> <p>GridEX® Type G Clip</p>
<p>MU Clip Assembly</p>  <p>M5 Hex Head Set Screw</p> <p>GridEX® Type M Clip</p> <p>GridEX® Type U Clip</p>	<p>MV Clip Assembly</p>  <p>M8 Hex Head Set Screw</p> <p>GridEX® Type M Clip</p> <p>GridEX® Type V Clip</p> <p>Lock Nut</p>
<p>M Clip 60% Open</p>  <p>M8 Hex Head Set Screw</p> <p>GridEX® M Clip for 60% Open Grating</p> <p>Flat Washer</p> <p>Lock Nut</p>	<p>M Clip 50% Open</p>  <p>M8 Hex Head Set Screw</p> <p>GridEX® M Clip for 50% Open Grating</p> <p>Flat Washer</p> <p>Lock Nut</p>

Please refer to Appendix 6c: GridEX® Fasteners Ordering Information (Page 97).

Not drawn to scale

P-Series® Phenolic Grating

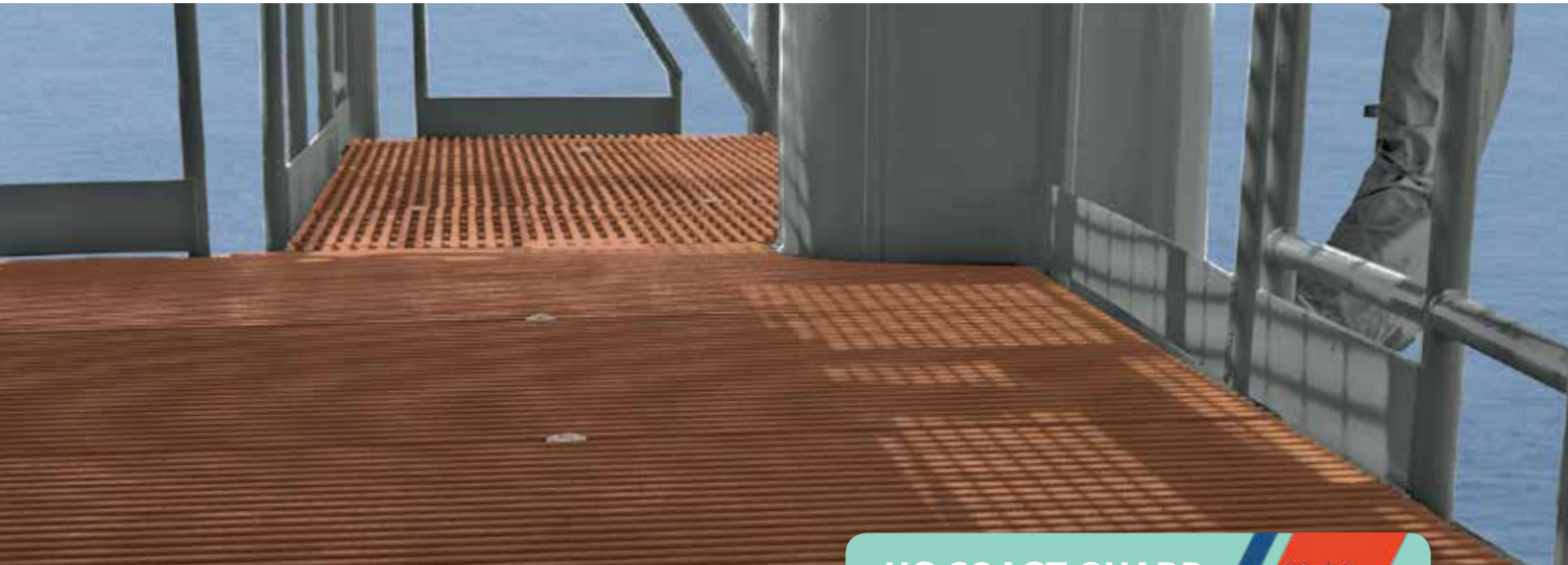

Treadwell's P-Series® Phenolic fibreglass or FRP grating is the ultimate choice for applications where fire risk is prevalent and when smoke cannot be allowed to develop.

Treadwell, through the employment of the most advanced production equipment and the use of the highest quality raw materials, has developed this unique range of leading offshore composite grating products. EX-Series® Phenolic Grating, which boasts US Coast Guard approval, is acceptable for use in areas and applications as outlined in the US Coast Guard Safety Manual Vol III.

Composite Grating with the Strength of Steel

EX-Series® Phenolic Grating can span up to 70% more than that of equivalent size standard steel grating. Furthermore, P-Series® will not yield and will return to its original shape if design loads are exceeded.

Ease of Installation

EX-Series® Phenolic Grating is only 65% of the weight of steel grating and often, can be manually installed with ease.

Safety Enhancing Anti-Slip Surface

This system unique to EX-Series® Grating Systems means that load bars are broader than those of metal grating and are far less fatiguing than conventional steel bar grating and not dangerously sharp like serrated surface grating.

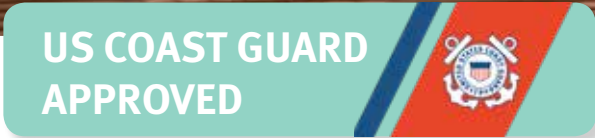

Extreme Fire and Impact Resistance

EX-Series® Phenolic Grating systems, which is laminated by an outer layer of resin rich Phenolic providing ultimate fire resistance, ensures extreme strength is maintained.

Typical Applications

- Jetties, wharfs & marine structures
- Offshore production platforms
- Offshore drilling platforms
- Grating
- Refineries
- Industrial/processing plants
- Shipboard applications
- Public Transport i.e. tunnels

Standard Panel Sizes

GratEX®	1225 mm x 3665 mm
	920 mm x 3055 mm
GridEX®	1524 mm x 6096 mm

Other custom panels sizes are achievable and readily available.

Installation Methods

Treadwell offers a range of Installation fixing systems designed for offshore wave zone environments as well as for standard industrial applications – refer to pages 38-41, 50, 68 and 80 for StormChief® system, which has a long-standing history of outstanding performance in the offshore industry.

Standard Colours



Antique Brown



Antique Yellow

P-Series® Phenolic Grating Specification

General

1.0 Scope

- 1.1 The grating shall conform to the material and fabrication requirements as per this specification.

2.0 Standards/Related documents

- 2.1 The grating system shall conform to the applicable sections of:
2.1.1 US coast guard approvals, level 2 and 3

3.0 Design Criteria

- 3.1 The design criteria of the fibreglass products (FRP) shall be in accordance with governing building codes and generally accepted standards in the FRP industry.
- 3.2 Design live loads shall be of ... kPa uniformly distributed load (or as per building code if more stringent) with a maximum deflection of ... mm at the centre of a single span according to product specifications.

4.0 Submittals

- 4.1 Shop drawings of all fabricated grating panels shall be submitted by Treadwell (unless provided by the client) displaying clearly material sizes, types, styles, product codes and including types and sizes of fasteners as well as a layout if required.
- 4.2 Technical data and sample pieces can also be submitted if required.

5.0 Quality Assurance

Quality surrounds every aspect of Treadwell's commitment to our superior products and efficiency. Treadwell's quality assurance strictly adheres to the high quality control standards placed to conform to relevant specifications, codes, Australian Standards and contractual requirements in a timely manner.

6.0 Product Delivery and Storage

- 6.1 All grating and components or ancillary items shall be fabricated as per the design and piece marked to design drawings.
- 6.2 All manufactured materials shall be delivered in unbroken packages.

Product System

7.0 Manufacturing Process

- 7.1 All fibreglass (FRP) items listed under this section shall be constructed from fibreglass reinforcement and resin of the quality necessary to meet the design requirements and dimensions as specified.
- 7.2 Fibreglass reinforcement shall be continuous roving and shall be in sufficient quantities as required for the application.
- 7.3 Resins shall be ... (refer to page 5) with chemical formulations as necessary to provide the corrosion resistance, strength and any other physical properties as required.
- 7.4 All finished surfaces to be smooth, resin-rich, free of voids and without dry spots, cracks or unreinforced areas and all fibreglass reinforcement shall be well covered with resin to protect against exposure due to weather or wear.
- 7.5 All fibreglass (FRP) items shall be EITHER non-fire retardant OR have a tested flame spread rating of 25 or less when tested in accordance with the ASTM E84 Tunnel Test.
- 7.6 Contact Treadwell regarding specification data relative to products conforming to ASTM D635.
- 7.7 All metal accessories shall be manufactured from (304 or 316) Stainless Steel, 2205 Duplex Stainless Steel, 2507 Super Duplex Stainless Steel, hot dipped galvanised steel or aluminium.
- 7.8 Load bars shall be joined with notched cross bars via interlocking methods and the use of chemical bonding.
- 7.9 The fibreglass reinforcement content shall be maintained at 65% (by weight) so as to achieve maximum loading capacity.
- 7.10 All fibreglass material shall have an ultraviolet light inhibiting chemical additive to resist UV degradation.
- 7.11 Grating shall be manufactured with a concave profile on top of each bar OR an anti-slip Aluminium Oxide surface to provide optimum slip resistance.

8.0 Acceptable Manufacturer

The fibreglass underfoot moulded grating system shall be manufactured by Treadwell Group Pty Ltd of Australia.

N Non-Stocked Item **C** Commonly Stocked Item

All Treadwell FRP grating products are available to order with any colour that you may specify.

While we carry one of the broadest offerings of commonly used colours, our FRP grating range offers unlimited flexibility when trying to match to an existing colour scheme. All of the grating types that make up the Treadwell range can be requested in a custom or RAL matched colour.

A selection of colours is offered below. It is important to note that our range is NOT limited to these colours and not all products may be immediately available in the colours listed below.

Standard Colours



Colours & Effects



Glow in the Dark Colours

Treadwell is also proud to offer innovative glow-in-the-dark products which use an embedded inorganic photo luminescent pigment that creates a green/yellow glow when active. The pigment is non-toxic, non-radioactive, and can be recharged repeatedly during the life of the product.

These products are an effective safety solution for both outdoor and indoor applications, with greater visibility for many hours after the light source has been removed.

The photo luminescent pigment is fully recharged after 5 minutes of exposure to sunlight, 8 minutes at dusk, or 10 minutes in fluorescent light; depending on the strength and nature of the light source. The higher the UV output, the brighter the illumination.

Two-Tone Colour Configurations

Colours can also be combined to create a two-tone configuration. Contrasting colours can be applied on (but not limited to):

- On the nosing and vertical lip of a step cover, increasing notice to the leading edge of a stair.
- On the perimeter of a walkway cover where a change in surface texture and colour signifies a safe walk zone.
- On RungSAFE® Covers.

In addition, it is an economical alternative to full photo luminescent covers combined with a solid colour. Not only do you have a two-tone configuration in the light, but also the benefit of glow in the dark when the light source is removed.

Descriptive Markings

Overhead safety warnings and signage can actually create a slip, trip and fall situation when the person fails to look down while walking. Worse yet, in the event of a fire or emergency, smoke and darkness often conceal overhead signage and directional guidance.

The image or message can be embedded into the cover, not just printed on the surface, so it will last for the life of the product and not wear off.

Treadwell can also incorporate your company logo and other custom graphics into the surface without affecting slip performance.



Anti-Slip Grit Grades

Cover Grit Options

Every grating surface has Treadwell’s unique layer of resin surface with embedded grit that characterises its high traction and safety traits. Depending on application, our range of grit covers can offer the highest anti-slip properties available on the market to smaller grits where specified.

Hardness of Grit

Treadwell incorporates a unique grit product into all of our anti-slip products. Measuring at 9.4 on Moh’s Hardness Scale, most tapes and paints which contain quartz or silica (in other words, sand) pale in comparison. These score a soft aggregate of 6-7 that will quickly wear away under foot traffic, leaving your surface more open to hazards.

Mohs Hardness Scale	
Diamond	10.0
Fused Alumina	9.4
Quartz Sand Most Anti-Slip Products Including Tapes	6-7



Ten Standards Grades



HygiGR8®

What is HygiGR8®

The Treadwell HygiGR8® range was initially developed to service the food and beverage processing industry with the emphasis on streamlining cleaning processes and addressing hygiene issues in food processing operations.

With product evolution, HygiGR8® is now available as a comprehensive solution when particles being entrapped between support members and grating is a concern.

HygiGR8® incorporates a unique blend of solid top and open grating technology. This is achieved through the calculated layout of HygiGR8® panels to ensure the solid top section of customisable width around the edge of each panel is located so that the beams that make up the substructure are covered by the solid band.

The grating system can be manufactured from any grade of resin for any industry including premium food grade polyester resin.

For HygiGR8® intended for food and beverage processing facilities, Treadwell certifies that food grade resin HygiGR8® meet USDA acceptance requirements when properly installed and maintained as an ergonomic or anti-slip floor surface or cover. Each panel is post cured and detergent washed.

This unique system can be adapted to any floor plan, for uses such as landings, slippery ramps, catwalks, decks etc. HygiGR8® also incorporates treads that can be manufactured to any standard for continuity of HygiGR8® over walkways and stairways.



HygiGR8® Features and Benefits vs. Traditional Alternatives

	HygiGR8®	Stainless Steel	Galvanised Steel	Aluminium	Polyurethane
Chemical Resistance	● ● ● ● ●	● ● ● ●	●	● ● ●	● ● ● ●
Strength	● ● ● ● ●	● ● ● ● ●	● ● ● ● ●	● ● ● ● ●	● ● ●
Lightweight	● ● ● ● ●	●	●	● ● ● ● ●	● ● ●
Electrical Resistance	● ● ● ● ●	●	●	●	● ● ● ● ●
Cleaning	● ● ● ● ●	● ● ●	● ● ●	● ● ●	●
Hygiene	● ● ● ● ●	● ● ● ●	●	● ●	● ● ● ●

HygiGR8® Surface Options

Anti-Slip Surface. HygiGR8® is recommended with a gritted anti-slip surface to ensure maximum grip in situations where there are typically moisture and slippery residues. It has an extremely effective coefficient of friction and is very hard-wearing (NATA laboratory test report available).



Concave Surface. HygiGR8® can also be ordered with the concave surface option. This ensures efficient and easier to clean environments where by-products are commonly caught between serrations. However, the anti-slip properties are not as profound as the gritted surface.



Residue Build Up Prevention

HygiGR8® Clip

The HygiGR8® clip was specifically designed to resolve the issue of residue caught in between the grating and support members, especially in food and mining environments. Together with DeckSAFE®, the HygiGR8® clip formulates a system that safeguards any build up in-between the apertures of the grating panels.

DeckSAFE®

DeckSAFE® has emerged as one of the market's genuine solutions for landings, slippery ramps, catwalks, decks, etc. It is mainly designed to eliminate the threats of trips, slips as well as falls in the workplace where there is direct contact with water, oil and other forms of liquids to reduce risks.

DeckSAFE® can be applied in customisable strips of up to 3m in length to be utilised in conjunction with the HygiGR8® clip.

Installation Guide

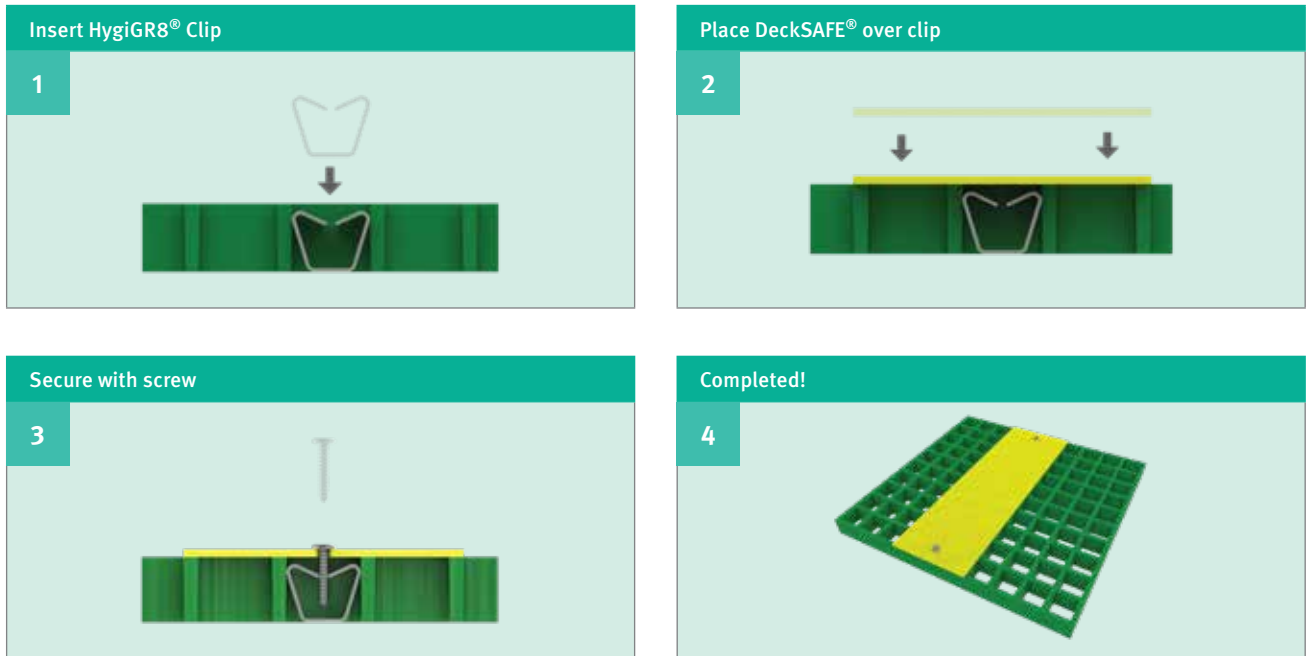

Fastening Clips

HygiGR8® Clip	3D	PLAN	ELEVATION
Hole Diameter: N/A Material Type: 316 st/st Threaded Hole: N/A			
Screw	3D	PLAN	ELEVATION
Threaded Size: 10mm Material Type: st/st Length: 22mm			

Not drawn to scale

Conductive Grating

What is EX-Series® Conductive Grating?

FRP gratings are typically non-conductive and this can sometimes present a safety issue when in a sparking sensitive environment due to the build-up of static electricity.

The black carbon surface in Treadwell's conductive grating is specially formulated to discharge static build-up on FRP grating surfaces in areas where static build-up presents a significant risk. When properly grounded, the conductive surface provides solutions that can be typically applied in areas where there is highly sensitive electrical equipment, munitions, chemical or petro chemicals present.

Treadwell's conductive grating drains off the build-up of unwanted, dangerous static electricity when grounded. This specialised grating produces an electrical resistance of less than 26-kilo-ohms per foot, while retaining other desirable characteristics of conventional FRP moulded grating.

The Treadwell moulded carbon top can be applied to any of the grating products specified in our range and can be combined with any of our resin formulations.







Based on NFPA77

Recommended 4 grounding attachments

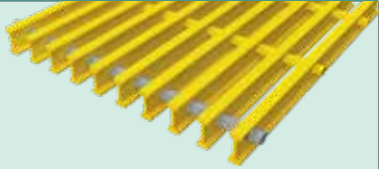
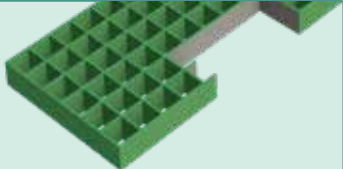
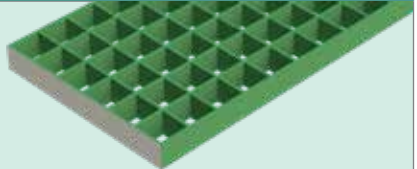
- Average Surface Resistivity - 2.5×10^3 ohms to 1×10^6 ohms per lineal foot
- Average Resistance to Ground - <108 ohms

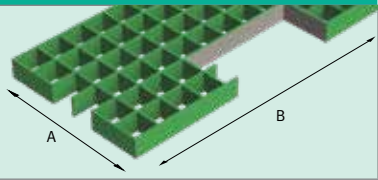
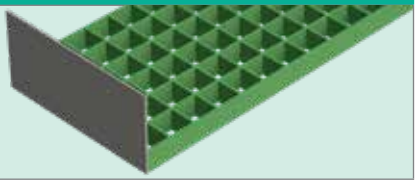

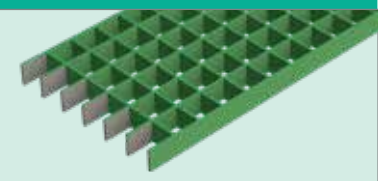
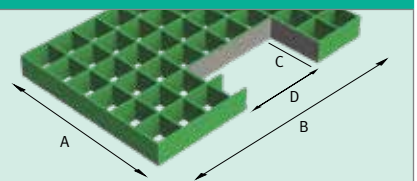
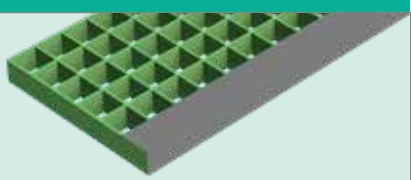
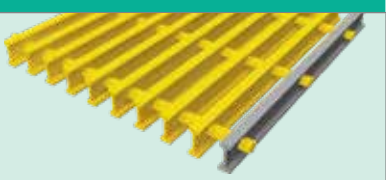
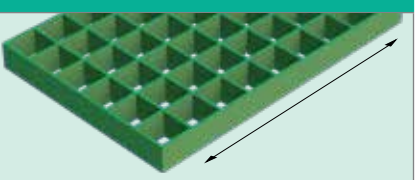
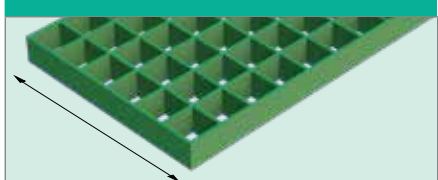
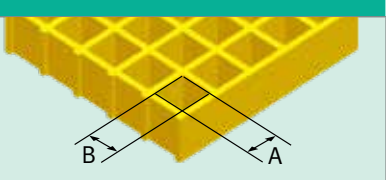
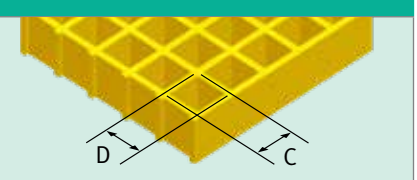
<p>Cross Bar A section fixed at right angles to the Load Bar designed to provide lateral strength — GridEX® pultruded grating is constructed using such members.</p>	<p>Cut Out Grating area removed from panels to permit passage of columns, handrail, pipes and structural items.</p>	<p>Edge Bar Banding The process of chemically bonding Load Bars (non-load bearing) to the cross bars after trimming to size to provide a uniform appearance on all sides of a grating panel. Available on GratEX® products.</p>
		
<p>Exact Size Refers to the requirement to manufacture the panels to an exact dimension and not to be adjusted to the nearest width across the standard pattern of the load bars.</p>	<p>Gross Area Total area including areas cut to waste (A x B).</p>	<p>Kick Plate A large flat section chemically bonded to side or end of panel and around cut-outs where specified. Nominal height is 100 mm above working surface.</p>
		
<p>Penetrations Cut out but within the grating panel as opposed to being on the edge.</p>	<p>Prongs In the case of GratEX®, this describes a panel cut that does not run adjacent to a load bar.</p>	<p>Net Area The area of panel remaining after deducting areas cut to waste [AxB]-[CxD].</p>
		
<p>Nosing The section on the leading edge of a stair tread or (top stair) loading panel to assist slip resistance and to give a clear visual indication of the edge of stair treads and loadings.</p>	<p>Load Bar A load carrying section from which grating is constructed spanning between two supports. GratEX® moulded grating consists of Load Bars in both directions, hence the product's exceptional bi-directional strength.</p>	<p>Length of Span Overall dimension of a panel measured parallel with load bar typically indicated by this symbol "↔". In the case of GratEX® (due to load bars being bi-directional), this is either the span or the longest dimension.</p>
		
<p>Width The overall dimension of a panel – in the case of GratEX®, this is the opposite dimension to the span, or the smaller dimension and in the case of GridEX®, this is the dimension measured at right angles to the load bars, even if greater than the length.</p>	<p>Aperture Where applicable (GratEX® and MoultrEX®), it refers to the length of opening surrounded by load bars. (A x B)</p>	<p>Load bar centres This refers to the distance between centre lines of two adjacent load bars. (C x D)</p>
		

Installation Suggestions & Tools

Installing and modifying or fabricating FRP products, and in particular grating, can be done with ease on site if needed, provided you have the right tools to do so. To assist you with ensuring you are equipped properly, we have provided the following information and guidelines.

Treadwell recommends that respiratory, eye, ear, and hand PPE be worn as a minimum whenever FRP products are being cut, drilled or modified in any form whatsoever.



Remember to measure twice, then cut once!

1. Measure & Mark

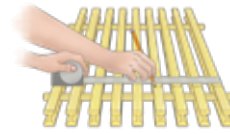

2. Check & Cut

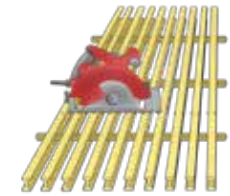

3. Seal & Fasten



Resin Sealer Kits



V-Series® Kits

500ml Kit

Trade Price Code: CPX-EX-SK-500-K

RRP: \$68.00 +GST

- 1 x 500ml tin of V-Series® (Vinylester) resin
- 1 x 15ml bottle of catalyst
- 1 x Small mixing cup
- 1 x brush
- 1 x Repair and Maintenance Manual

1000ml Kit

Trade Price Code: CPX-EX-SK-1000-K

RRP: \$126.00 +GST

- 1 x 1000ml tin of V-Series® (Vinylester) resin
- 2 x 30ml bottle of catalyst
- 2 x Small mixing cup
- 4 x brush (or maybe 2?)
- 1 x Repair and Maintenance Manual

Economy Diamond Blades



Code	Details
CPX-B-ED-110	110mm
CPX-B-ED-125	125mm
CPX-B-ED-230	230mm

Premium Diamond Blades



Code	Details
CPX-B-PD-110	110mm
CPX-B-PD-125	125mm
CPX-B-PD-230	230mm

Reciprocating Saw Blade And Jigsaw Blades



Code	Details
CPX-B-RS-210	Reciprocating (210mm)
CPX-B-JS-75	Jigsaw (75mm)
CPX-B-JS-100	Jigsaw (100mm)

Drill Bits



Code	Details
CPX-DB-M5	For M5
CPX-DB-M6	For M6
CPX-DB-M8	For M8
CPX-DB-M10	For M10
CPX-DB-M12	For M12
CPX-DB-M14	For M14

TCT Hole Cutters



Code	Details
CPX-TCT-12	12mm
CPX-TCT-14	14mm
CPX-TCT-16	16mm
CPX-TCT-20	20mm
CPX-TCT-22	22mm

Mixing Cups



Code	Details
CPX-MC-400	400mL
CPX-MC-650	650mL
CPX-MC-1300	1300mL

Drafting Information & Manufacturing Tolerances



Save on detailed drafting

When providing Treadwell with grating drawings, please ensure that only the outline of the actual grating is supplied along with all penetrations and cut-outs are displayed.

Treadwell will recommend the most economical breakdown of panels to suit your floor layout — this is because our forte in FRP products means that we stock more standard size panels. Save yourself the cost and let us take the pain out of it for you.

Treadwell utilises up to date CAD technology to create panel details and erection marking plans. Further, we can then have these drawings sent via email, fax, post or courier to any location for speedy approval or mark-up — a service many of our clients agree saves a lot of time and hassle!

All we need from you

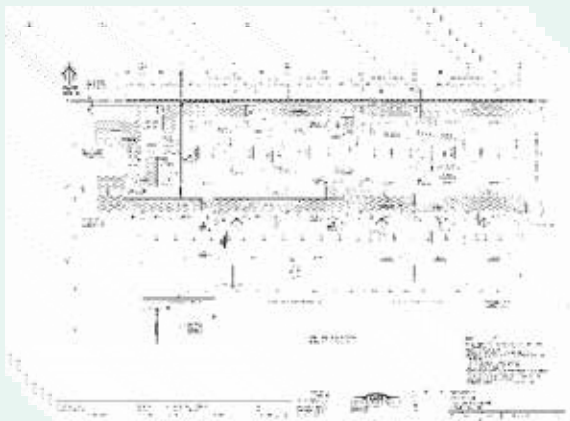

What we will provide you with



Panels	Size (mm)	Length (mm)	Width (mm)	Thickness (mm)
	920 X 3055	± 3	± 3	± 1.5
	1225 X 3665 or larger	± L / 1000	± 3	± 1.5
Stairtreads	Size (mm)	Width (mm)	Depth (mm)	Thickness (mm)
	All sizes	± 3	± 3	± 1.5

Embedment Angle

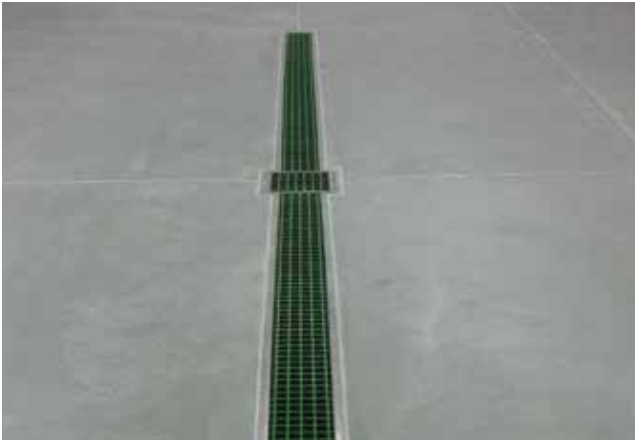

The Treadwell ArchitEX™ FRP Embedment Angle provides a very sturdy base for bearing bars and has a built-in continuous angle that locks into concrete, eliminating the need for individual anchors. The FRP embedment angle is engineered using a surfacing veil and fire retardant vinylester resin system.

This unique combination produces superior strength, stiffness, wear protection and long-term corrosion resistance required for longevity in industrial applications. The FRP embedment angle is suitable for use with both GratEX®, MoultrEX® and GridEX® products and is typically available in grey 3 m or 6 m lengths.

Code	Depth	Width	Weight
ARX-EA25	25.4 mm	38.1 mm	1.34 kg/m
ARX-EA38	38.1 mm	38.1 mm	1.52 kg/m
ARX-EA51	50.8 mm	38.1 mm	1.64 kg/m

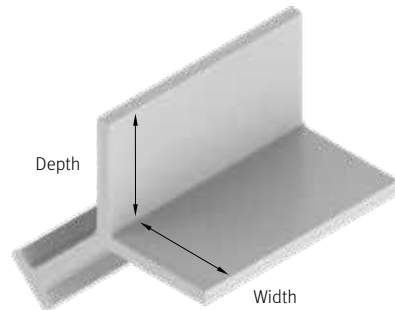

Safety Ramp



Treadwell's lightweight safety ramps can be adapted to any application. Flexible and sturdy enough to take even the heaviest of weights, they are resistant to fire, chemicals and corrosion. Being anti-slip in nature, FRP safety ramps are an extremely safe surface for your ramps in all types of weather.

Efficient and cost effective alternative to stainless or galvanised steel angles, these safety ramps can be readily installed onto domestic walkways, providing effective both pedestrian and wheel access.

Profile	Code	Depth	Width
25 mm	GTX-253838SS-ITYG3*-RMP	120 mm	3660 mm
32 mm	GTX-323838SS-ITYG3*-RMP	120 mm	3660 mm
38 mm	GTX-383838SS-ITYG3*-RMP	120 mm	3660 mm
50 mm	GTX-505050SS-ITYG3*-RMP	158 mm	3660 mm

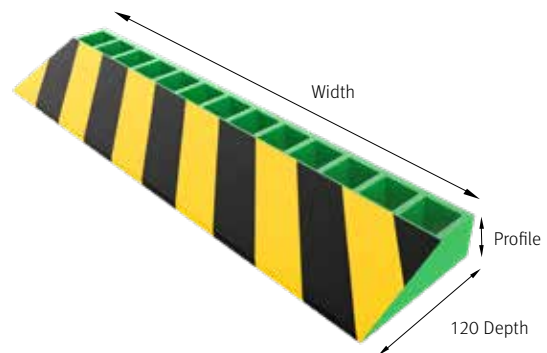

*Please note that the resin composition and colouration are customisable according to specifications. Please speak to us about the many options available to suit your needs.

StormChief

Treadwell developed the StormChief® grating fastening system to provide a solution for fastening down grating products in environments that experience high wave action and subsequently require a fastening system that is designed to withstand wave zone loadings.

Wave action exerts extreme forces on grating, sometimes causing panels to be wrenched off substructures. This damage affects large industrial offshore structures such as oil and gas drilling platforms, dockside walkways or decks, and marine based recreational public infrastructure.

StormChief® Wave Zone Grating Fasteners save organisations large expenses in downtime due to access complications and restrictions and reinstallation costs. Additionally, the systems provide time saving installation methods such as the StormChief® Hybrid System which eliminates the necessity for access to the underside of the substructure.



StormChief GRIP

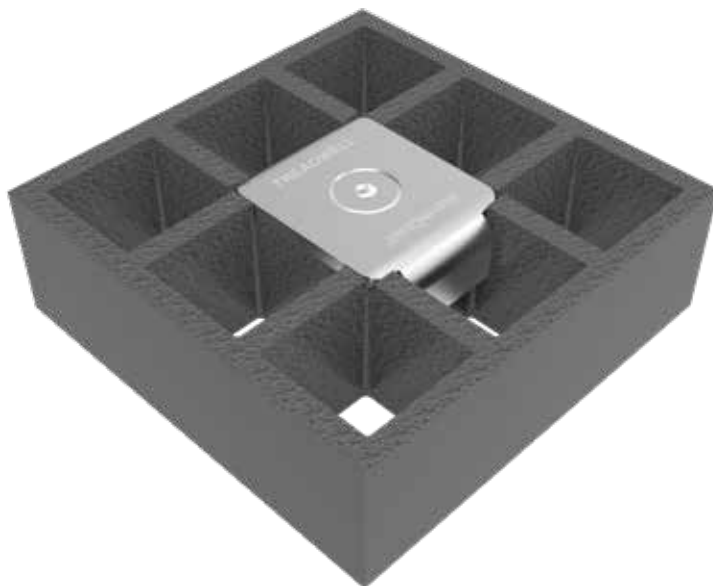

Plan View



Elevation View

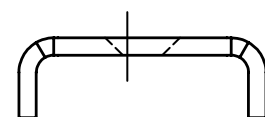

The StormChief® GRIP is ideal for stair treads or grating where the fasteners need to be near the edges, to accommodate load bar considerations. Incredibly secure, this tough fixing clip is made from 316 stainless steel and designed to withstand high wave zone loadings. Sitting flat against the grating, it eliminates risks of trips and snags.

StormChief DISC®



Plan View

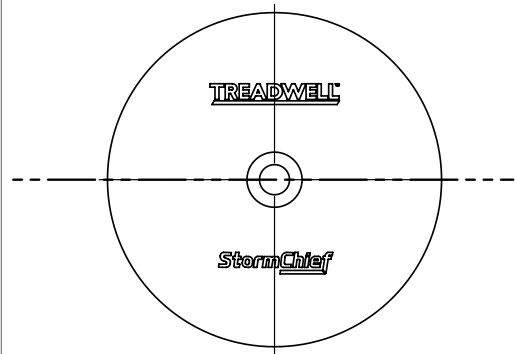

Elevation View

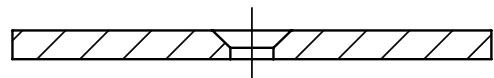

The StormChief DISC® is an extremely robust and secure grating fastening system intended for use in areas that experience high wave zone loadings. The DISC is designed to be used when the width of a walkway or deck area exceeds 1200mm or requires securing in situations where the application of the CLAW system is impractical. The DISC is recessed to ensure safe and secure pathway for all types of traffic accessing the area. This system is compatible with the H-Clip fastener and the StormChief® Hybrid System.

WARRANTY

Treadwell offers a bespoke warranty for the StormChief® grating fastening system, provided the following conditions are satisfied:

1. Treadwell prepares the product system and associated attachment hardware drawings and details, and supplies the product system and associated hardware for the product system; and
2. Treadwell is permitted to inspect the installation of the particular product system, or be permitted access to the work for final inspection and approval, and recommend the necessary corrections, if required;
3. In the event of product dissatisfaction, Treadwell be permitted access to the site for the purpose of verifying that the complaint is a direct result of Treadwell's design and/or installation.

For further information, contact your Treadwell representative.

StormChief® Recess Tool



StormChief CLAW®

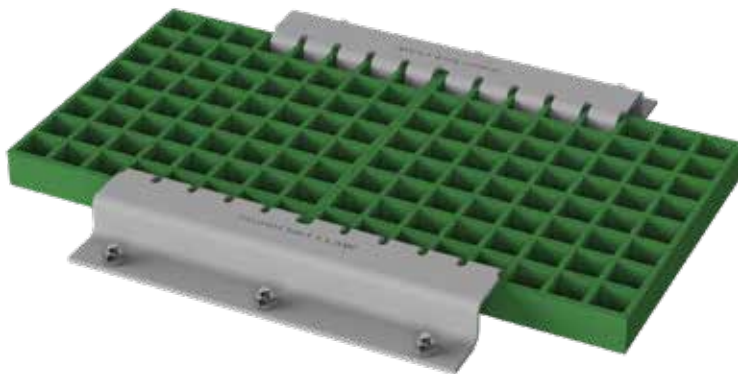

Plan View

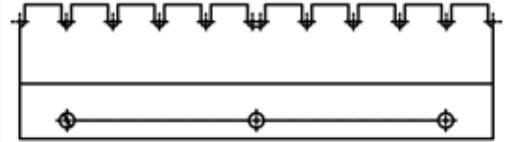

Elevation View

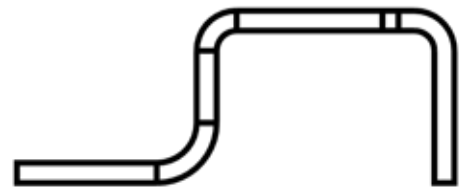

The StormChief CLAW® is a heavy duty 316 Stainless Steel grating fixing bracket that is designed to meet and exceed specifications for wave zone loadings. With integrated fingers that protrude into the grating aperture, the StormChief CLAW® provides secure fastening in even the harshest of coastal conditions. Used exclusively in conjunction with the StormChief® Hybrid System, it ensures simple, strong and rapid installation.

StormChief CLAMP®

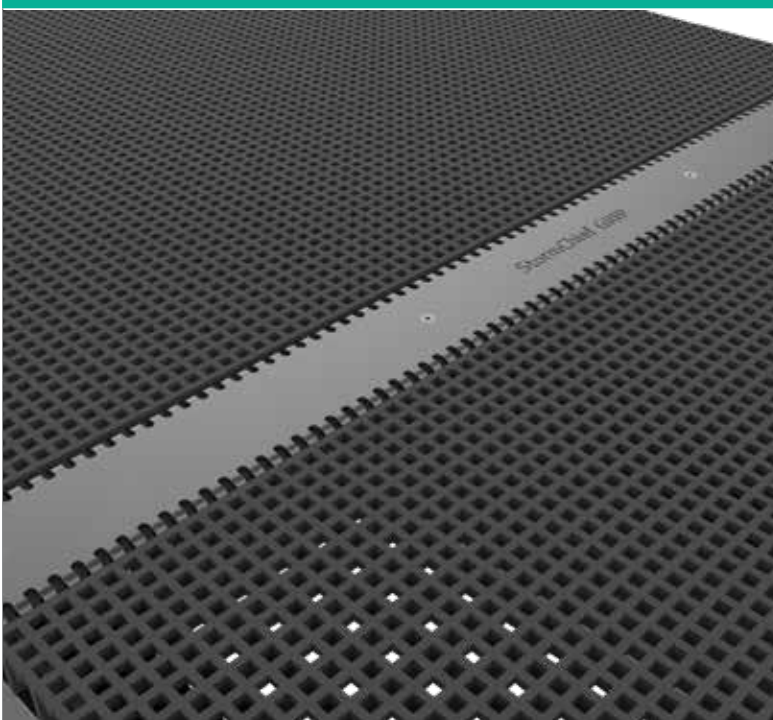

Plan View



Elevation View

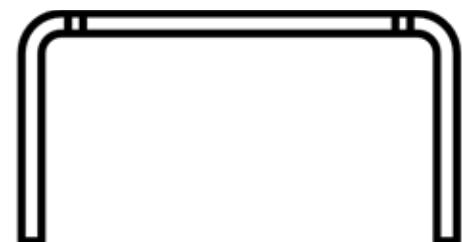

The StormChief CLAMP® is a rugged stainless steel clamping bracket that is designed to meet and exceed the requirements of extreme wave zone loadings. The StormChief CLAMP® is a unique clamping system designed by Treadwell to seamlessly join two sheets of grating along one edge. This clip is easily recessed into the grating to ensure minimal trip hazard, making it ideal for public access areas that are subject to harsh coastal conditions.

Access Hatches, Handles & Hinge Systems

Access Hatches, Handles & Hinge Systems

Treadwell can custom design any type of cover or hatch using GratEX® Solid Surface Mesh and can simply and effectively make these lockable, removable and even hinged through the use of standard and custom ancillary products such as handles, hinges, frames and cam locks.

If you should have a unique application, please don't hesitate to contact us – there is a good chance we've encountered something similar in the past.

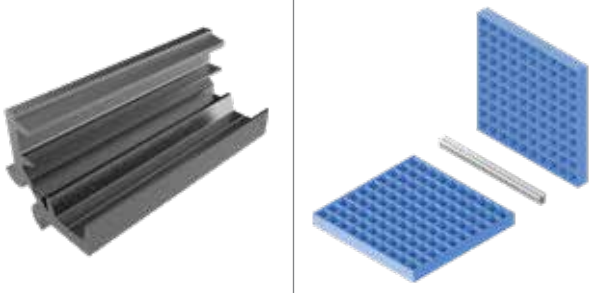
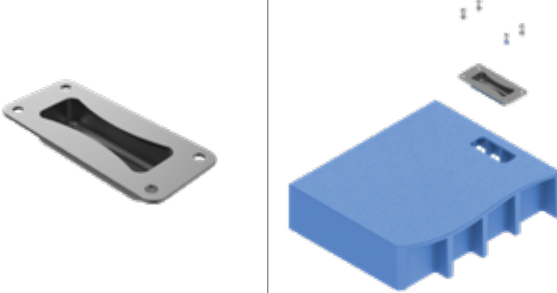
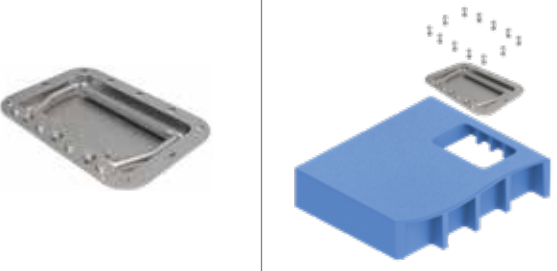
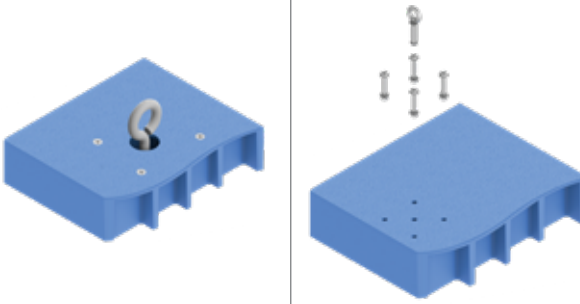
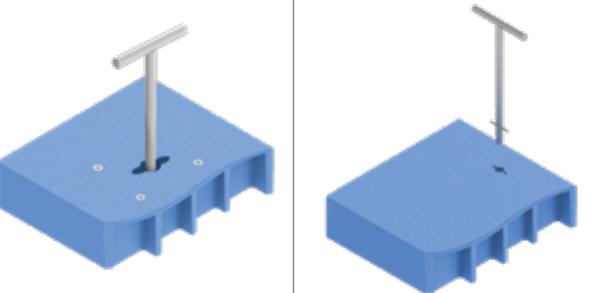
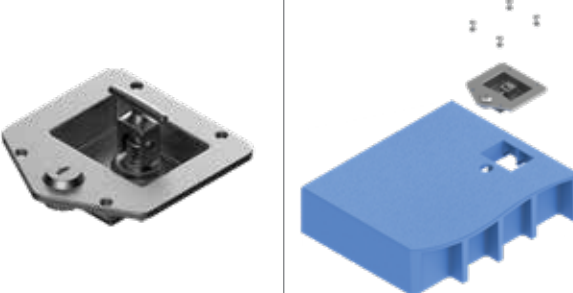
<p>EX-Series® Non-Metallic Hinge</p> 	<p>EX-Series® Non-Metallic Recessed Handle</p> 
<p>EX-Series® Spring Loaded Handle</p> 	<p>EX-Series® Eyelet Lift Kit</p> 
<p>EX-Series® T-Bar Handle/Keyhole Lift Kit</p> 	<p>EX-Series® Lockable Handle</p> 

Not drawn to scale

Elevated Support Systems

GratEX® Adjustable FRP Elevated Floor System					
	GratEX® Adjustable FRP Elevated Floor System				
	<table border="1"> <tr> <td>Code</td> <td>MG-AEFS</td> </tr> <tr> <td>UOM</td> <td>Unit/Each</td> </tr> </table>	Code	MG-AEFS	UOM	Unit/Each
	Code	MG-AEFS			
UOM	Unit/Each				
<p>This adjustable pedestal, constructed completely from FRP, is designed specifically for GratEX®. It provides excellent support for elevated flooring and has a long-standing history of outstanding performance in corrosive applications. Pedestals are available in polyester and vinylester resin systems. Standard colours are grey and black.</p>					

GratEX® FRP Elevated Floor System					
	GratEX® FRP Elevated Floor System				
	<table border="1"> <tr> <td>Code</td> <td>MG-EFS</td> </tr> <tr> <td>UOM</td> <td>Unit/Each</td> </tr> </table>	Code	MG-EFS	UOM	Unit/Each
	Code	MG-EFS			
UOM	Unit/Each				
<p>This fixed pedestal, also constructed from FRP, is designed for the support of elevated walkways and accessways in dosing rooms and other areas where items on floors make access difficult. Pedestals are available in polyester and vinylester resin systems. Standard colours are grey and yellow.</p>					

Colossus Pedestal

This unique range of non-metallic adjustable crew-jack elevated flooring pedestals offer uninterrupted adjustability and can support loads of more than 1,000 kg per pedestal. They can be adjusted to compensate up to 5% pitch, or compensate for locally uneven sub-bases up to the same amount. Once pedestals are at the required height (uninterruptedly adjustable between 17mm – 1070mm), their position is fixed with unique lockable keys.

INCREDIBLE SLOPE CORRECTION (UP TO 5%!)

Designed to adapt to any environment, the incredibly flexible slope correction feature, which is integrated on the heads of larger pedestals and supplied separately for the smaller ones, makes for extremely simplistic and quick installation of false floors.

UNIQUE HEIGHT LOCKING SYSTEM

Specifically developed to lock the pedestal at the required height, this feature ensures no subsequent rotational movement caused by traffic or vibration will destroy the integrity of your false floor over time.

PITCH ALTERATION BAND

This unique feature which is 115mm in diameter allows for the screw pitch of the pedestal to be reversed if required, making your job of levelling a false floor installation a cinch!

EXCELLENT SURFACE SUPPORT

With a surface area of 175cm² and a diameter of 150mm, the head of the pedestal is screwed directly onto the base, or on to the coupler. And, what's more, the head, with a diameter of 150mm, can be fitted with various components to support different surfaces.

EXTENSION COUPLERS AVAILABLE

Couplers are able to be used whenever the height of the pedestal exceeds 175mm. Two integrated tabs on either side allow for mechanical fixing or cross bracing, guaranteeing enhanced stability when the height exceeds 600mm.

STOUT & STURDY BASE

The base can be simply positioned or fixed to any substrate. It has fixing holes for screw or bolts. The head, couplers and bases have safety 'stop' pins to prevent over extension. The base has a surface area of 314 cm² and a diameter of 200mm.

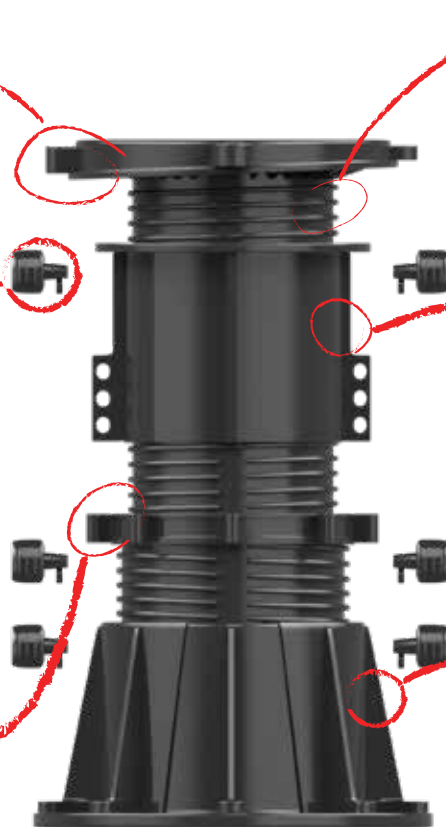

Elevated Support Systems

<p>GTX-PD-17</p> <p>17mm</p> 	<p>GTX-PD-28</p> <p>28mm</p> 	<p>GTX-PD-25-36</p> <p>25-36mm</p> 	<p>GTX-PD-35-53</p> <p>35-53mm</p> 	<p>GTX-PD-50-78</p> <p>50-78mm</p> 
<p>GTX-PD-75-108</p> <p>75-108mm</p> 	<p>GTX-PD-100-175</p> <p>100-175mm</p> 	<p>GTX-PD-175-285</p> <p>175-285mm</p> 	<p>GTX-PD-285-400</p> <p>285-400mm</p> 	<p>GTX-PD-355-515</p> <p>355-515mm</p> 
<p>GTX-PD-465-625</p> <p>465-625mm</p> 	<p>GTX-PD-545-740</p> <p>545-740mm</p> 	<p>GTX-PD-645-850</p> <p>645-850mm</p> 	<p>GTX-PD-720-960</p> <p>720-960mm</p> 	<p>GTX-PD-830-1070</p> <p>830-1070mm</p> 

Not drawn to scale

Appendix 1; Load Data Tables

Concentrated Line Load

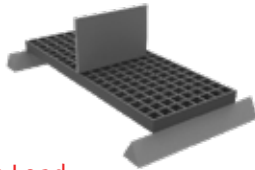

Uniform Load



1. The following tables were developed in accordance with the test method developed by the Fibreglass Grating Manufacturers Council (FGMC) of the American Composites Manufacturers Association(ACMA) for the Fibreglass Grating Standard.
2. The designer should not exceed MAXIMUM RECOMMENDED load at any time. MAXIMUM LOAD represents factors of safety are different for moulded and pultruded grating (moulded - 5:1, pultruded - 2:1) for ULTIMATE CAPACITY. ULTIMATE CAPACITY represents MAX LOAD observed at initial fracture.
3. The loads represented are for STATIC LOAD CONDITIONS at ambient temperature. Deflections for impact loads or dynamic loads will MULTIPLY the deflections shown by 2. Long term loads will result in added deflection due to creep in the material and will require higher factors of safety to ensure acceptable performance.
4. For GratEX® and MoultrEX® rectangular gratings, the support span is along the length of apertures. For GridEX® gratings, the support span is along load bars.

Appendix 2; Chemical Resistance Guide

Information contained in this guide is based on data collected from several years of actual industrial applications. Recommendations are based on conservative evaluations of the changes which occur in certain properties of replicate laminates after exposures of one year or longer, both in the laboratory and the field.

Temperatures are neither the minimum nor the maximum but represent standard test conditions (Room Temperature & 70°C). The products may be suitable at higher temperatures but individual

test data should be required to establish such suitability. Contact Treadwell for any special applications that you may have.

The recommendations (• : resistant: –:not resistant) contained in this specification sheet are made without guarantee or representation as to results. We suggest that you evaluate these recommendations and suggestions in your own laboratory or actual field trial prior to use. Our responsibility for claims arising from breach of warranty, negligence, or otherwise **is limited to the purchase price of the material.**

Chemical	I-Series®		V-Series®	
	Room Temp	70°C	Room Temp	70°C
Acetaldehyde	–	–	–	–
Acetic Acid 0-25%	•	•	•	•
Acetic Acid 25-50%	•	–	•	•
Acetic Anhydride	–	–	–	–
Acetone	–	–	–	–
Acrylonitrile	–	–	–	–
Alcohol, Butyl	–	–	•	–
Alcohol, Ethyl 10%	–	–	•	66
Alcohol, Ethyl 100%	–	–	•	–
Alcohol, Isopropyl 10%	–	–	•	66
Alcohol, Isopropyl 100%	–	–	•	–
Alcohol, Methyl 10%	–	–	•	66
Alcohol, Methyl 100%	–	–	–	–
Alcohol, Methyl Isobutyl	–	–	•	66
Alcohol, Secondary Butyl	–	–	•	66
Aluminium	•	•	•	•
Aluminium Chloride	•	•	•	•
Aluminium Hydroxide	•	–	•	49
Aluminium Nitrate	•	•	•	•
Aluminium Potassium Sulfate	•	•	•	•
Ammonia, Aqueous 0-10%	–	–	•	38
Ammonia, Gas	–	–	•	38
Ammonium Bicarbonate	•	–	•	49
Ammonium Bisulfite	–	–	•	49

	I-Series®		V-Series®	
	Room Temp	70°C	Room Temp	70°C
Ammonium Carbonate	–	–	•	49
Ammonium Citrate	•	–	•	49
Ammonium Fluoride	–	–	•	49
Ammonium Hydroxide 5%	•	–	•	49
Ammonium Hydroxide 10%	•	–	•	49
Ammonium Hydroxide 20%	–	–	•	49
Ammonium Nitrate	•	•	•	49
Ammonium Persulfate	–	–	•	49
Ammonium Phosphate	–	–	•	49
Ammonium Sulfate	•	•	•	•
Arsenious Sulfate	•	–	•	•
O-Benzoyl Benzoic Acid	–	–	•	•
Barium Carbonate	•	–	•	•
Barium Chloride	•	–	•	•
Barium Hydroxide	–	–	•	49
Barium Sulfate	•	•	•	•
Barium Sulfide	–	–	•	•
Beer	•	–	•	49
Benzene	–	–	–	–
5% Benzene in Kerosene	•	–	•	•
Benzene Sulfonic Acid	•	•	•	•
Benzoic Acid	•	–	•	•
Benzyl Alcohol	–	–	•	–
Benzyl Chloride	–	–	–	–

Appendix 2; Chemical Resistance Guide

Chemical	I-Series®		V-Series®	
	Room Temp	70°C	Room Temp	70°C
Brass Plating Solution:				
– 3% Copper Cyanide	—	—	•	•
– 6% Sodium Cyanide	—	—	•	•
– 1% Zinc Cyanide	—	—	•	•
– 3% Sodium Carbonate	—	—	•	•
Butyl Acetate	—	—	—	—
Butyric Acid 0-50%	•	—	•	•
Butylene Glycol	•	•	•	•
Cadmium Chloride	•	—	•	•
Cadmium Cyanide Plating Soln:				
– 3% Cadmium Oxide	—	—	•	49
– 6% Sodium Cyanide	—	—	•	49
– 1% Caustic Soda	—	—	•	49
Calcium Bisulfate	•	•	•	•
Calcium Carbonate	•	—	•	•
Calcium Chlorate	•	•	•	•
Calcium Chloride	•	•	•	•
Calcium Hydroxide	•	—	•	49
Calcium Hypochlorite	•	—	•	49
Calcium Nitrate	•	•	•	•
Calcium Sulfate	•	•	•	•
Calcium Sulfite	•	•	•	•
Caprylic Acid	•	—	•	•
Carbon Dioxide	•	•	•	•
Carbon Disulfide	—	—	—	—
Carbon Monoxide	•	•	•	•
Carbon Tetrachloride	—	—	•	38
Carbon Acid	•	—	•	•
Castor Oil	•	•	•	•
Carbon Methyl Cellulose	—	—	•	49
Chlorinated Wax	—	—	•	•
Chlorine Doxide/Air	•	—	•	•
Chlorine Dioxide, Wet Gas	—	—	•	•
Chlorine, Dry Gas	—	—	•	•
Chlorine, Wet Gas	—	—	•	•
Chlorine, Liquid	—	—	—	—
Chlorine, Water	—	—	•	•
Chloroacetic Acid 0-50%	—	—	•	38
Chlorobenzene	—	—	—	—
Chloroform	—	—	—	—
Chlorosulfonic Acid	—	—	—	—
Chromic Acid 20%	—	—	•	49
Chromic Acid 30%	—	—	—	—
Chromium Sulfate	•	•	•	•
Citric Acid	•	•	•	•

Chemical	I-Series®		V-Series®	
	Room Temp	70°C	Room Temp	70°C
Coconut Oil	•	—	•	•
Copper Chloride	•	•	•	•
Copper Cyanide	—	—	•	•
Copper Fluoride	—	—	•	•
Copper Nitrate	•	•	•	•
Copper Plating Solution:				
– Copper Cyanide	—	—	•	•
– 10.5% Copper	—	—	•	•
– 4% Copper Cyanide	—	—	•	•
– 6% Rochelle Salts	—	—	•	•
Copper Brite Plating:				
– Caustic Cyanide	—	—	•	38
Copper Plating Solution:				
– 45% Copper Fluorobrate	—	—	•	•
– 19% Copper Sulfate	—	—	•	•
– 8% Sulfuric Acid	—	—	•	•
Copper Matte Dipping Bath:				
– 30% Ferric Chloride	—	—	•	•
– 19% Hydrochloric	—	—	•	•
Copper Pickling Bath:				
– 10% Ferric Sulfate	—	—	•	•
– 10% Sulfuric Acid	—	—	•	•
Copper Sulfate	•	•	•	•
Corn Oil	•	—	•	•
Corn Starch-Slurry	•	—	•	•
Corn Sugar	•	—	•	•
Cottonseed Oil	•	—	•	•
Crude Oil, Sour	•	—	•	•
Crude Oil, Sweet	•	—	•	•
Cyclohexane	•	—	•	49
Detergents, Sulfonated	•	—	•	•
Di-Ammonium Phosphate	•	—	•	•
Dibromophenol	—	—	—	—
Dibutyl Ether	—	—	•	49
Dichloro Benzene	—	—	—	—
Dichloroethylene	—	—	—	—
Diesel Fuel	•	—	•	•
Diethylene Glycol	•	—	•	•
Dimethyl Phthalate	—	—	•	•
Diocetyl Phthalate	—	—	•	•
Diprophylene Glycol	•	—	•	•
Dodecyl Alcohol	—	—	•	•
Esters, Fatty Acids	•	•	•	•
Ethyl Acetate	—	—	—	—
Ethyl Benzene	—	—	—	—

Appendix 2; Chemical Resistance Guide

Chemical	I-Series®		V-Series®	
	Room Temp	70°C	Room Temp	70°C
Ethyl Ether	—	—	—	—
Ethylene Glycol	•	•	•	•
Ethylene Dichloride	—	—	—	—
Fatty Acids	•	•	•	•
Ferric Chloride	•	•	•	•
Ferric Nitrate	•	•	•	•
Ferric Sulfate	•	•	•	•
Ferrous Chloride	•	•	•	•
Ferrous Nitrate	•	•	•	•
Ferrous Sulfate	•	•	•	•
8-8-8 Fertiliser	•	—	•	49
Fertiliser:				
– Urea Ammonium Nitrate	—	—	•	49
Fuel Gas	—	—	•	•
Fluoboric Acid	—	—	•	49
Fluosilicic Acid 0-20%	—	—	•	•
Formaldehyde	•	—	•	•
Formic Acid	•	—	•	•
Fuel Oil	•	—	•	•
Gas Natural	•	—	•	•
Gasoline, Auto	•	—	•	•
Gasoline, Aviation	•	—	•	•
Gasoline, Ethyl	•	—	•	•
Gluconic Acid	•	—	•	•
Gasoline, Sour	•	—	•	•
Glucose	•	•	•	•
Glycerine	•	•	•	•
Glycol, Ethylene	•	•	•	•
Glycol, Propylene	•	•	•	•
Glycolic Acid	•	—	•	•
Gold Plating Solution:				
– 63% Potassium Ferrocyanide	—	—	•	•
– 2% Potassium Gold Cyanide	—	—	•	•
– 8% Sodium Cyanide	—	—	•	•
Heptane	•	—	•	•
Hexane	•	—	•	•
Hexylene Glycol	•	•	•	•
Hydraulic Fluid	•	—	•	•
Hydrobromic Acid 0-25%	•	—	•	•
Hydrochloric Acid 0-37%	•	—	•	•
Hydrocyanic Acid	•	—	•	•
Hydrofluoric Acid 10%	—	—	•	—
Hydrofluosilicic Acid, 10%	—	—	•	•
Hydrogen Bromide, Wet Gas	—	—	•	•
Hydrogen Chloride, Dry Gas	—	—	•	•

Chemical	I-Series®		V-Series®	
	Room Temp	70°C	Room Temp	70°C
Hydrogen Chloride, Wet Gas	—	—	•	•
Hydrogen Peroxide	—	—	•	49
Hydrogen Sulfide, Dry	•	—	•	•
Hydrogen Sulfide, Aqueous	•	—	—	•
Hydrogen Fluoride, Vapour	—	—	•	•
Hydrosulfite Bleach	—	—	•	49
Hydrochloric Acid 0-10%	—	—	—	—
Iron Plating Solution:				
– 45% FeCl: 15% CaCl	—	—	•	•
– 20% FeCl: 11% (NH ₄) ₂ SO ₄	—	—	•	•
Iron And Steel Cleaning Bath:				
–9% Hydrochloric: 23% Sulfuric	—	—	•	•
Isopropyl Amine	—	—	•	38
Isopropyl Palmitate	•	•	•	•
Jet Fuel	•	—	•	•
Kerosene	•	—	•	•
Lactic Acid	•	—	•	•
Lauryl Chloride	—	—	•	•
Lauric Acid	•	—	•	•
Lead Acetate	•	—	•	•
Lead Chloride	•	—	•	•
Lead Nitrate	•	—	•	•
Lead Plating Solution:				
–.8% Fluoboric, 0.4% Boric Acid	—	—	•	•
Levulinic Acid	•	—	•	•
Linseed Oil	•	•	•	•
Lithium Bromide	•	•	•	•
Lithium Sulfate	•	•	•	•
Magnesium Bisulfite	•	—	•	•
Magnesium Carbonate	•	—	•	•
Magnesium Chloride	•	•	•	•
Magnesium Hydroxide	—	—	•	60
Magnesium Nitrate	•	—	•	•
Magnesium Sulfate	•	•	•	•
Maleic Acid	•	•	•	•
Mercuric Chloride	•	—	•	•
Mercurous Chloride	•	—	•	•
Methylene Chloride	—	—	—	—
Methyl Ethyl Ketone	—	—	—	—
Methyl Isobutyl Carbitol	—	—	—	—
Methanol (See Alcohol)	•	—	•	•
Methyl Isobutyl Ketone	—	—	—	—
Methyl Styrene	—	—	—	—
Mineral Oils	•	•	•	•
Molybdenum Disulfide	•	—	•	•

Appendix 2; Chemical Resistance Guide

Chemical	I-Series®		V-Series®	
	Room Temp	70°C	Room Temp	70°C
Monochloro Acetic Acid	—	—	—	—
Monoethanolamine	—	—	—	—
Motor Oil	•	•	•	•
Myristic Acid	—	—	•	•
Naptha	•	•	•	•
Napthalene	•	—	•	•
Nickel Chloride	•	•	•	•
Nickel Nitrate	•	•	•	•
Nickel Plating:				
– 8% Lead, 0.8% Flouboric Acid	—	—	•	•
– 0.4% Boric Acid	—	—	•	•
Nickel Plating:				
– 11% Nickel Sulfate	•	—	•	•
– 2% Nickel Chloride	•	—	•	•
– 1% Boric Acid	•	—	•	•
Nickel Plating:				
– 44% Nickel Sulfate	•	—	•	•
– 4% Ammonium Chloride	•	—	•	•
– 4% Boric Acid	•	—	•	•
Nickel Sulfate	•	•	•	•
Nitric Acid 0-5%	•	•	•	•
Nitric Acid 20%	—	—	•	49
Nitric Acid Fumes	—	—	—	—
Nibrobenzene	—	—	—	—
Octanoci Acid	•	—	•	•
Oil, Sour Crude	•	•	•	•
Oil, Sweet Crude	•	•	•	•
Oleic Acid	•	•	•	•
Oleum (Fuming Sulfuric)	—	—	—	—
Olive Oil	•	•	•	•
Oxalic Acid	•	•	•	•
Peroxide Bleach:				
– 25% Peroxide 95%	•	•	•	•
– 0.025% Epsom Salts	•	•	•	•
– 5% Sodium Silicate 42.Be	•	•	•	•
– 1.4% Sulfuric Acid 66.Be	•	•	•	•
Phenol	—	—	—	—
Phenol Sulfonic Acid	—	—	—	—
Phosphoric Acid	•	•	•	•
Phosphoric Acid Fumes	•	•	•	•
Phosphorous Pentoxide	•	•	•	•
Phosphorous Trichloride	—	—	—	—
Phthalic Acid	•	•	•	•
Pickling Acids (Sulfuric & Hydrochloric)	•	•	•	•
Picric Acid, Alcoholic	—	—	—	—

Chemical	I-Series®		V-Series®	
	Room Temp	70°C	Room Temp	70°C
Polyvinyl Acetate Latex	•	—	•	•
Polyvinyl Alcohol	•	—	•	38
Polyvinyl Chloride Latex W/35 (Parts Dop)	—	—	•	49
Potassium Aluminium Sulfate	•	•	•	•
Potassium Bicarbonate	•	—	•	60
Potassium Bromide	•	—	•	38
Potassium Carbonate	•	—	•	60
Potassium Chloride	•	•	•	•
Potassium Dichromate	•	—	•	60
Potassium Ferricyanide	•	•	•	•
Potassium Ferrocyanide	•	•	•	•
Potassium Hydroxide	—	—	•	66
Potassium Nitrate	•	•	•	•
Potassium Permanganate	•	—	•	60
Potassium Persulfate	•	—	•	•
Potassium Sulfate	•	•	•	•
Propionic Acid 1-50%	—	—	•	49
Propionic Acid 50-100%	—	—	—	—
Propylene Glycol	•	•	•	•
Pulp Paper Mill Effluent	•	—	•	•
Pyridine	—	—	—	—
Salicylic Acid	—	—	•	60
Sebacic Acid	—	—	•	•
Selenious Acid	—	—	•	•
Silver Nitrate	•	•	•	•
Silver Plating Solution:				
– 44% Silver Cyanide	—	—	•	•
– 7% Potassium Cyanide	—	—	•	•
– 5% Sodium Cyanide	—	—	•	•
– 2% Potassium Carbonate	—	—	•	•
Soaps	•	—	•	•
Sodium Acetate	•	—	•	•
Sodium Benzoate	•	—	•	•
Sodium Bicarbonate	•	•	•	•
Sodium Bifluoride	•	—	•	49
Sodium Bisulfate	•	•	•	•
Sodium Bisulfite	•	•	•	•
Sodium Bromate	•	•	•	60
Sodium Bromide	•	•	•	•
Sodium Carbonate 0-25%	•	—	•	•
Sodium Chlorate	•	—	•	•
Sodium Chloride	•	•	•	•
Sodium Chlorite	•	—	•	•
Sodium Chromite	•	•	•	•
Sodium Cyanide	•	—	•	•

Appendix 2; Chemical Resistance Guide

Chemical	I-Series®		V-Series®	
	Room Temp	70°C	Room Temp	70°C
Sodium Dichromate	•	•	•	•
Sodium Di-Phosphate	•	•	•	•
Sodium Ferricyanide	•	•	•	•
Sodium Fluoride	•	—	•	49
Sodium Fluoro Silicate	—	—	•	49
Sodium Hexametaphosphates	—	—	•	38
Sodium Hydroxide 0-5%	—	—	•	66
Sodium Hydroxide 5-25%	—	—	•	66
Sodium Hydroxide 50%	—	—	•	66
Sodium Hydrosulfide	•	—	•	•
Sodium Hypochlorite	•	—	•	66
Sodium Lauryl Sulfate	•	•	•	•
Sodium Mono-Phosphate	•	•	•	•
Sodium Nitrate	•	•	•	•
Sodium Silicate	•	—	•	•
Sodium Sulfate	•	•	•	•
Sodium Sulfide	•	—	•	•
Sodium Sulfite	•	—	•	•
Sodium Tetra Borate	•	•	•	•
Sodium Thiocyanate	—	—	•	•
Sodium Thiosulfate	•	—	•	•
Sodium Tripolyphosphate	•	—	•	•
Sodium Xylene Sulfonate	•	—	•	•
Sodium Solutions	•	—	•	•
Sodium Crude Oil	•	•	•	•
Soya Oil	•	•	•	•
Stannic Chloride	•	•	•	•
Stannous Chloride	•	•	•	•
Stearic Acid	•	•	•	•
Styrene	—	—	—	—
Sugar, Beet And Cane Liquor	•	—	•	•
Sugar, Sucrose	•	•	•	•
Sulfamic Acid	•	—	•	•
Sulfanilic Acid	•	—	•	•
Sulfated Detergents	•	—	•	•
Sulfur Dioxide, Dry Or Wet	—	—	•	•
Sulfur Trioxide/Air	—	—	•	•
Sulfuric Acid 0-30%	•	•	•	•
Sulfuric Acid 30-50%	—	—	•	•
Sulfuric Acid 50-70%	—	—	•	49
Sulfurous Acid	—	—	•	38
Superphosphoric Acid (76% P2 O5)	•	—	•	•
Tall Oil	•	—	•	60
Tannic Acid	•	—	•	66
Tartaric Acid	•	•	•	•

Chemical	I-Series®		V-Series®	
	Room Temp	70°C	Room Temp	70°C
Thionyl Chloride	—	—	—	—
Tin Plating:				
– 18% Stannous Fluorborate	—	—	•	•
– 7% Tin	—	—	•	•
– 9% Fluoroboric Acid	—	—	•	•
– 2% Boric Acid	—	—	•	•
Toluene	—	—	—	—
Toluene Sulfonic Acid	—	—	•	•
Transformer Oils:				
– Mineral Oil Types	•	•	•	•
– Chloro-Phenyl Types)	•	•	•	•
Trichlor Acetic Acid	•	—	•	•
Trichlorethylene	—	—	—	—
Trichloropentol	—	—	—	—
Tricresyl Phosphate	—	—	•	49
Tridecylbenzene Sulfonate	•	—	•	•
Trisodium Phosphate	•	—	•	•
Turpentine	—	—	•	38
Urea	—	—	•	38
Vegetable Oils	•	•	•	•
Vinegar	•	•	•	•
Vinyl Acetate	—	—	—	—
Water:				
– Deionised	—	—	—	—
– Demineralised	•	•	•	•
– Distilled	•	•	•	•
– Fresh	•	•	•	•
– Salt	•	•	•	•
– Sea	•	•	•	•
White Liquor (Pulp Mill)	•	—	•	•
Xylene	—	—	—	—
Zinc Chlorate	•	•	•	•
Zinc Nitrate	•	•	•	•
Zinc Plating Solution:				
– 9% Zinc Cyanide	—	—	•	49
– 4% Sodium Cyanide	—	—	•	49
– 9% Sodium Hydroxide	—	—	•	49
Zinc Plating Solution:				
– (49% Zinc Fluoroborate	•	—	•	•
– 5% Ammonium Chloride	•	—	•	•
– 6% Ammonium Fluoroborate	•	—	•	•
Zinc Sulfate	•	•	•	•

Appendix 3; GratEX® Ordering Codes

Product code is defined into (GTX)-(38)(3838SS)-(I)(TG)(G3)-(01). The different possible combinations are expanded in the tables below.

GTX-383838SS-ITGG3-01				
Code	Description			
GTX	Fibreglass Moulded Grating - GratEX®			
38	Mesh Thickness			
	13	13mm	30	30mm
	14	14mm	35	35mm
	15	15mm		
	20	20mm	38	38mm
	22	22mm	50	50mm
	23	23mm		
	25	25mm	60	60mm
3838SS	Standard Square Mesh			
	3838SS = 38.1mm x 38.1mm			
	4040SS = 40mm x 40mm			
	5050SS = 50.8mm x 50.8mm			
	7979SS = 79mm x 79mm			
	8383SS = 83mm x 83mm			
	Heavy Duty Square Mesh			
	3838HS = 38.1mm x 38.1mm			
	Square Mini Mesh			
	1919M1 = 19.1mm x 19.1mm			
	2020M1 = 20mm x 20mm			
	2525M1 = 25.4mm x 25.4mm			
	Square Micro Mesh			
	1313M2 = 13.3mm x 13.3mm			
	Standard Rectangular Mesh			
	1025SR = 100mm x 25mm			
	1038SR = 100mm x 38mm			
	1525SR = 152mm x 25mm			
	Heavy Duty Rectangular Mesh			
	1025HR = 100mm x 25mm			
	5025HR = 50mm x 25mm			
	Solid Surface (3mm) Mesh			
	3838F3 = 38.1mm x 38.1mm			
	5050F3 = 50.8mm x 50.8mm			
	7979F3 = 79mm x 79mm			
	Solid Surface (5mm) Mesh			
	3838F5 = 38.1mm x 38.1mm			
	5050F5 = 50.8mm x 50.8mm			
	7979F5 = 79mm x 79mm			
	Heavy Duty Solid Surface (3mm) Mesh			
	3838H3 = 38.1mm x 38.1mm			
	Heavy Duty Solid Surface (5mm) Mesh			
3838H5 = 38.1mm x 38.1mm				

Appendix 3; GratEX® Ordering Codes

I	Resin Type	
	O = O-Series®	
	I = I-Series®	
	V = V-Series®	
	P = P-Series®	
TG	Colour	
	TY = Treadwell Yellow	TG = Treadwell Green
	DG = Dark Grey	CH = Charcoal
	LG = Light Grey	CC = Custom Colour
G3	Surface Option	
	G1 = Barefoot Grade Grit	CO = Concave
	G2 = Commercial Grade Grit	PL = Plain (Smooth)
	G3 = Industrial Grade Grit	CH = Chequer Plate
	G4 = Marine Grade Grit	DP = Diamond Plate
01	Standard Square Mesh / Solid Surface (3mm or 5mm) Mesh	
	01 = 1225mm x 3665mm	
	02 = 920mm x 3055mm	
	03 = 610mm x 3665mm	
	04 = 1225mm x 4040mm	
	CC = Custom Size*	
	Heavy Duty Square Mesh / Heavy Duty Solid Surface (3 or 5mm) Mesh	
	01 = 1225mm x 3665mm	
	02 = 920mm x 3055mm	
	CC = Custom Size*	
	Square Mini Mesh	
	01 = 1225mm x 3665mm ** (For 1919M1 / 2525M1)	
	05 = 1247mm x 4047mm	
	06 = 1247mm x 3647mm	
	07 = 1247mm x 2407mm	
	08 = 1247mm x 2627mm	
	09 = 1247mm x 3687mm	
	11 = 1527mm x 3007mm	
	12 = 1247mm x 3007mm	
	13 = 1247mm x 1807mm	
	14 = 1247mm x 2007mm	
	Custom Size	
	Square Micro Mesh	
	05 = 1247mm x 4047mm	
	09 = 1247mm x 3687mm	
	CC = Custom Size*	
	Standard Rectangular Mesh / Heavy Duty Rectangular Mesh	
	01 = 1225mm x 3665mm	
	CC = Custom Size*	
	Note: This section of coding is separated by a dash (-), it isn't required for custom jobs as GratEX® is available in a variety of size panels to suit applications.	

Appendix 4: MoultrEX® Ordering Codes

Product code is defined into (MTX)-(38)(1025)(SR)-(I)(TG)(G3)-(01). The different possible combinations are expanded in the tables below.

MTX-381025SR-ITGG3-01		
Code	Description	
MTX	Fibreglass Moultruded Grating - MoultrEX®	
38	Mesh Thickness	
	38	38mm
1025	Mesh Aperture	
	1025 = 100mm x 25mm	
SR	Mesh Detail	
	SR = Standard Rectangular Mesh	
I	Resin Type	
	O = O-Series®	
	I = I-Series®	
	V = V-Series®	
TG	Colour	
	TY = Treadwell Yellow	
	DG = Dark Grey	
	LG = Light Grey	
	TG = Treadwell Green	
	CH = Charcoal	
G3	Surface Option	
	G1 = Barefoot Grade Grit	
	G2 = Commercial Grade Grit	
	G3 = Industrial Grade Grit	
	G4 = Marine Grade Grit	
	CO = Concave	
	PL = Plain (Smooth)	
01	Panel Size	
	01 = 1225mm x 3665mm	
	CC = Custom*	
Note: This section of coding is separated by a dash (-), it isn't required for custom jobs as MoultrEX® is available in a variety of size panels to suit applications .		

Appendix 5: GridEX® Ordering Codes

Product code is defined into (GDX)-(38)(1523IB)-(I)(TG)(G3)-(01). The different possible combinations are expanded in the tables below.

GDX-381523IB-ITGG3-01				
Code	Description			
GDX	Fibreglass Pultruded Grating - GridEX®			
38	Mesh Thickness			
	25	25mm	50	50mm
	38	38mm	76	76mm
1523IB	I Type Load Bar Detail			
	1510IB = 15mm bar width and 10mm space			
	1515IB = 15mm bar width and 15mm space			
	1523IB = 15mm bar width and 22.9mm space			
	0805IB = 7.9mm bar width and 5.3mm space			
	T Type Load Bar Detail			
	2513TB = 25.4mm bar width & 12.7mm space			
	2525TB = 25.4mm bar width & 25.4mm space			
	Bar Type Load Bar Detail			
	1510BB = 15.2mm bar width & 10.2mm space			
1515BB = 15.2mm bar width & 15.2mm space				
1523BB = 15.2mm bar width & 22.9mm space				
I	Resin Type			
	I = I-Series®			
	V = V-Series®			
P = P-Series®				
TG	Colour			
	TY = Treadwell Yellow			
	DG = Dark Grey			
	LG = Light Grey			
	TG = Treadwell Green			
	CH = Charcoal			
CC = Custom Colour				
G3	Surface Option			
	G1 = Barefoot Grade (Grit) Anti-Slip			
	G2 = Commercial Grade (Grit) Anti-Slip			
	G3 = Industrial Grade (Grit) Anti-Slip			
	G4 = Marine Grade (Grit) Anti-Slip			
	PL = Plain (Smooth)			
	CV = Covered			
RB = Ribbed				
01	Panel Size			
	O1 = 1200mm x 5800mm			
	CC = Custom*			
Note: This section of coding is separated by a dash (-), it isn't required for custom jobs as GridEX® is available in a variety of size panels to suit applications.				

Appendix 6a: GratEX® Fasteners Ordering Information

Product code is defined into (GTX)-(M-S388)-(316). The different possible combinations are expanded in the tables below.

GTX-M-S38-316	
Code	Description
GTX	Fibreglass Moulded Grating - GratEX®
M-S38	Standard M Clip
	M-S15 = 15mm thick grating
	M-S25 = 25mm thick grating
	M-S38 = 38mm thick grating
	M-S50 = 50mm thick grating
	M Clip for mini mesh grating
	M-M14 = 14mm thick grating
	M-M22 = 22mm thick grating
	M-M38 = 38mm thick grating
	M-M50 = 50mm thick grating
	C Clip
	C-S25 = 25mm thick Standard grating
	C-S30 = 30mm thick Standard grating
	C-S38 = 38mm thick Standard grating
	C-S50 = 50mm thick Standard grating
	C-H38 = 38mm thick Heavy Duty grating
	C-H50 = 50mm thick Heavy Duty grating
	Standard L Clip
	L-S25 = 25mm thick grating
	L-S38 = 38mm thick grating
	L-S50 = 50mm thick grating
	StormChief® Disc
	SC-DIS = 100mm Diameter StormChief Disc
	Standard D Clip
	D-S38 = 38mm x 38mm Standard Mesh
	D-S50 = 50mm x 50mm Standard Mesh
	Standard W Clip
	W-S38 = 38mm x 38mm Standard Mesh
	W-S50 = 50mm x 50mm Standard Mesh
	Standard E Clip
	E-S38 = 38mm x 38mm Standard Mesh
	Standard S Clip
	S-S00 = Universal
Standard O Clip	
O-S00 = Universal	

Appendix 6a: GratEX® Fasteners Ordering Information

	Bottom Clip
	J Clip
	J-S00 = For Standard Mesh
	J-M00 = For Mini Mesh
	Standard H Clip
	H-S00 = For Standard Mesh
	Standard G Clip
	G-S00 = For Standard Mesh
	Standard U Clip
	U-S00 = For Standard Mesh
	V Clip
	V-S00 = For Standard Mesh
	V-M00 = For Mini Mesh
	Standard T Clip
	T-S00 = For Standard Mesh
316	Clip Material
	316 Stainless Steel

Appendix 6b: MoultrEX® Fasteners Ordering Information

MTX-M-381025SR-316	
Code	Description
MTX	Fibreglass Moultruded Grating - MoultrEX®
M	Clip Type
	M M Clip
38	Mesh Thickness
	38 38mm
1025	Mesh Aperture
	1025- 100mm x 25mm
SR	Mesh Detail
	SR = Standard Rectangular Mesh
316	Clip Material
	316 Stainless Steel

Appendix 6c: GridEX® Fasteners Ordering Information

Product code is defined into (GDX)-(M-251515IB)-(316). The different possible combinations are expanded in the tables below.

GDX-M-251515IB-316	
Code	Description
GDX	Fibreglass Pultruded Grating - GridEX®
M-251515IB	M Clip for I Bar
	M-251515IB = 25mm thick x 15mm bar width and 15mm space
	M-251523IB = 25mm thick x 15mm bar width and 23mm space
	M-381515IB = 38mm thick x 15mm bar width and 15mm space
	M-381523IB = 38mm thick x 15mm bar width and 23mm space
	M Clip for T bar
	M-502525TB = 50mm thick x 25.4mm bar width and 25.4mm space
	N Clip for I Bar
	N-381510IB = 15.2mm bar width and 10.2mm space
	N-500805IB = 7.9mm bar width and 5.3mm space grating
	H Clip
	H-P00 = 7.9mm bar width and 5.3mm space grating
316	Clip Material
	316 Stainless Steel

Notes

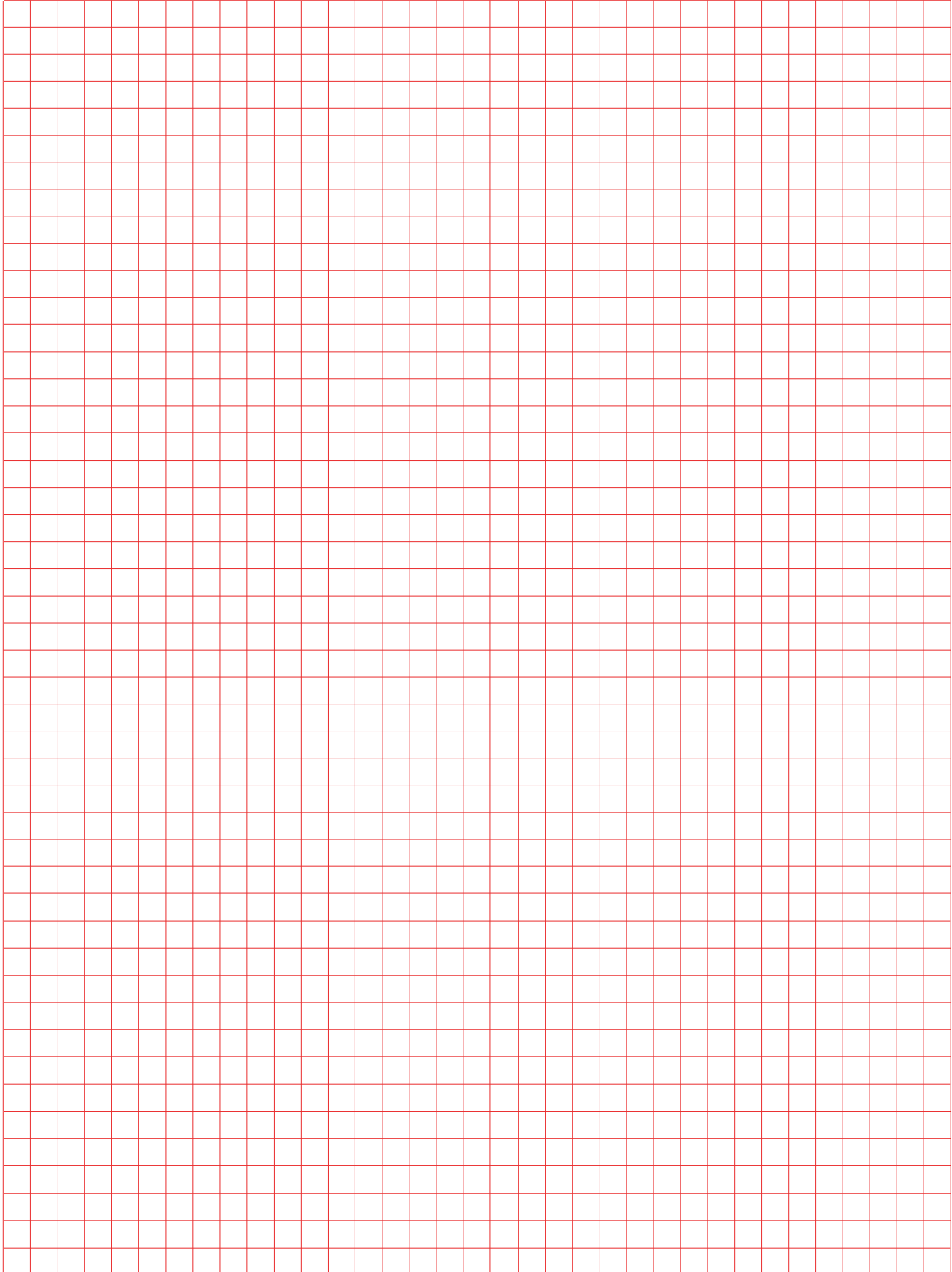
A large grid of red lines on a white background, intended for taking notes. The grid consists of 20 columns and 30 rows of small squares.

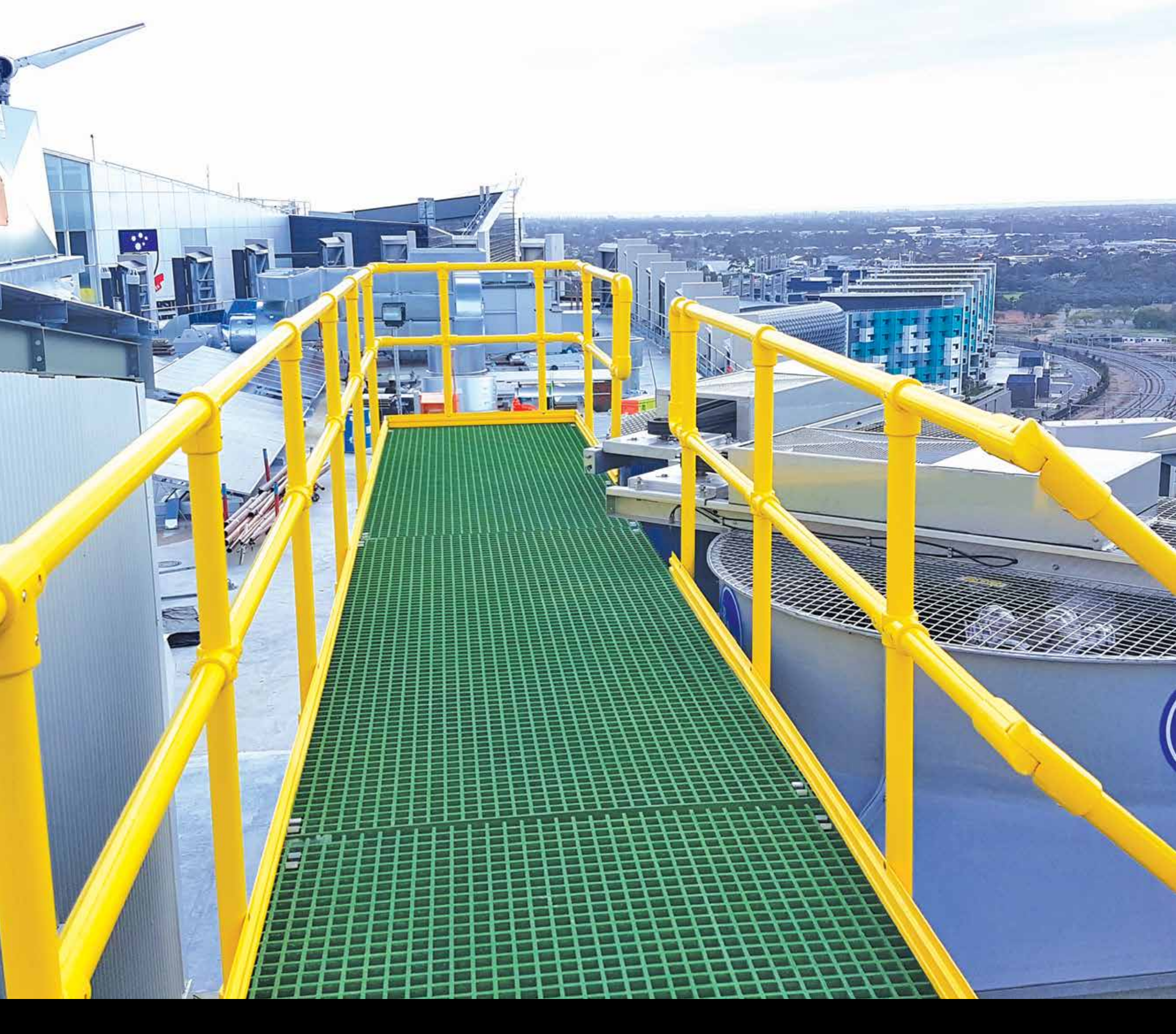

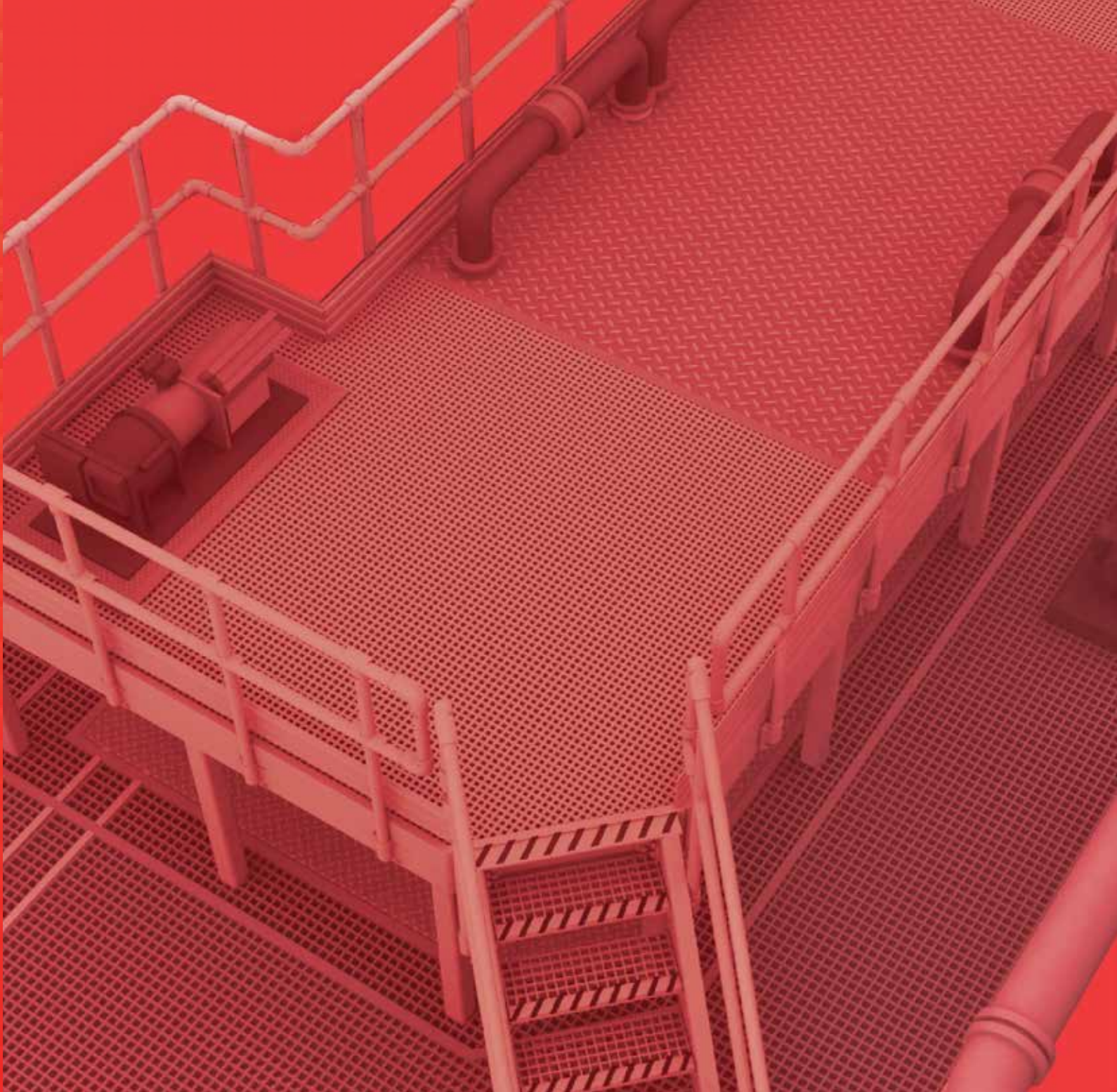
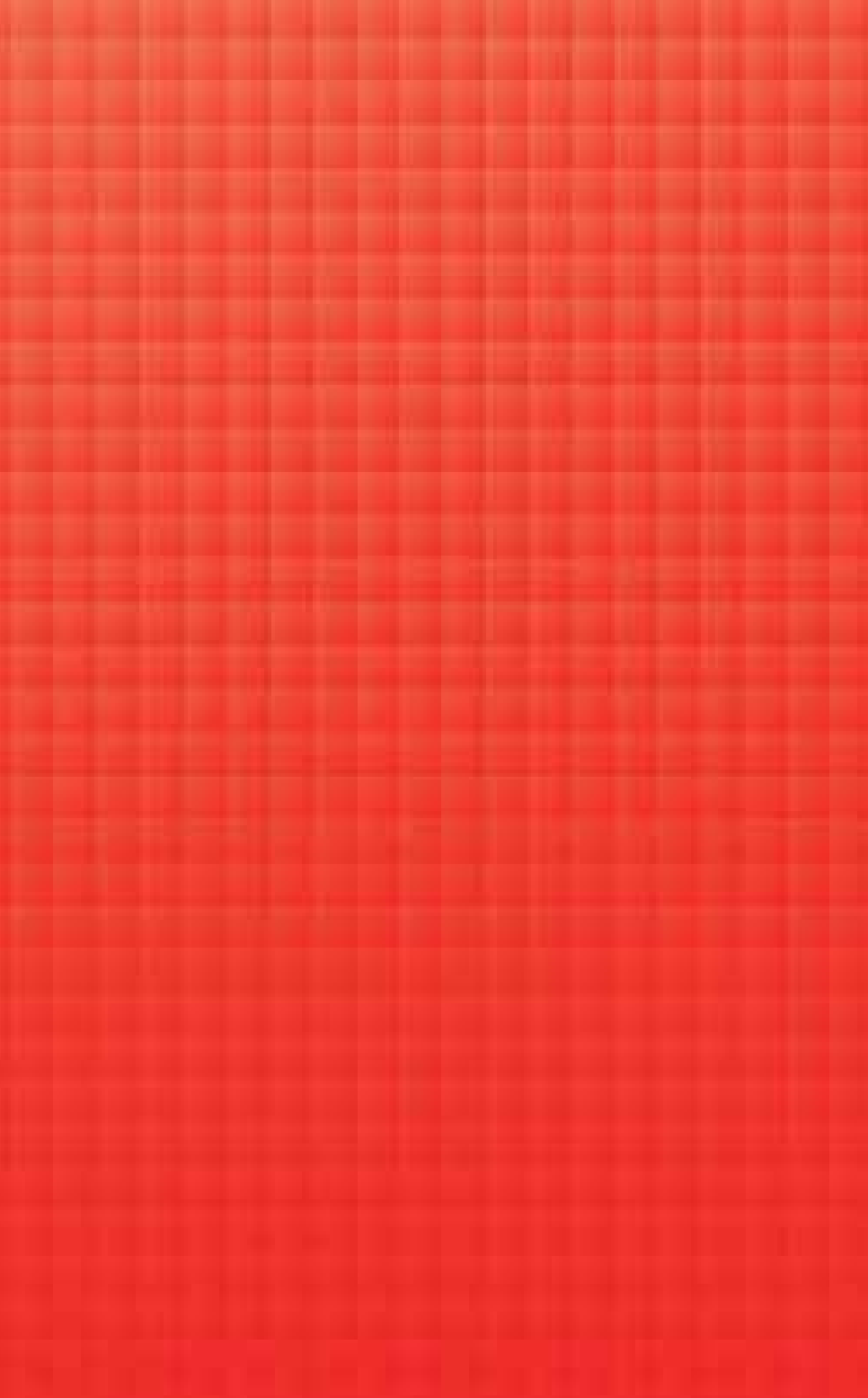

TREADWELL™

Treadwell brands mentioned in this document are all registered brands of Treadwell Group Pty Ltd. All pictures and information are supplied as a guide only. The complete range of Treadwell products are developed, refined, made to meet and exceed stringent specifications for the worldwide market.

Important Note: Sales of products are subject to our Terms and Conditions which are available upon request. All specifications and photos are a guide only and are subject to change without notice. Please ring to confirm details. Treadwell products stated only comply with relevant standards mentioned within this publication when installed and used as they are designed to be.

