



EX-Series®

GratEX®
MoultrEX®
GridEX®

Grating Product Guide

World leaders in the design and supply
of Fibreglass Reinforced Plastic (FRP)
Access Systems for industry.



The team at Treadwell is excited and proud to be releasing the latest version of the FRP Grating Product Guide to the market.

Treadwell's product range has expanded progressively since our last release of our FRP grating guide and now includes extensive offerings such as GratEX® Moulded FRP Grating, MoultrEX® Moultruded FRP Grating and GridEX® FRP Pultruded Grating, Flooring and Stair Treads. These products are offered with an encompassing range of ancillary components and fastenings, as well as floor elevation and embedment products.

Our EX-Series® FRP grating is designed for use in a multitude of environments where the grating may be subjected to continuous spills, electrical dangers, fumes, splashes or submersions. In such demanding environments, FRP grating will outperform the standard traditional grating options. Our FRP grating is available in standard panels or can be customised to specification.

Now with warehouses and distribution centres throughout Australia and New Zealand. Treadwell is your one stop shop for FRP - we stock, we modify and we deliver to ensure that Treadwell is the name you can rely on.

A BRIEF HISTORY

Treadwell Group is one of the most established names in the supply of Access Systems throughout Australia.

Our centrally located Adelaide fabrication facility, coupled with our second to none distribution network across Australia and our commitment to quality and testing, allows our technical staff to provide engineering and design assistance for any project.

With a broad history of installation in a wide range of challenging applications, including industrial process plants, mining applications, marine and costal environments as well as public infrastructure, Treadwell has the experience to help you specify the right resin systems and products every time.

If you have any unique design problems, chances are we've encountered something similar before. Get in contact today - Freecall 1800 246 800.

Treadwell Group Pty Ltd

Australia
P 1800 246 800
sales@treadwellgroup.com.au
treadwellgroup.com.au

New Zealand
P 0800 244 600
sales@treadwellgroup.co.nz
treadwellgroup.co.nz



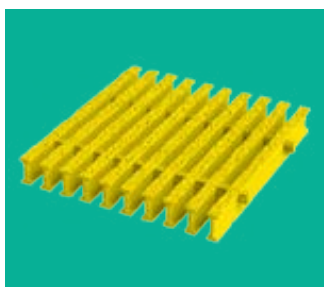

- 04 Ex-Series® Grating Key Selection Considerations
- 05 EX-Series® Resin Selection Guide

GratEX®

- 06 GratEX® Moulded Fibreglass Grating
- 07 GratEX® Square Mesh
- 12 GratEX® Heavy Duty Square Mesh
- 14 GratEX® Mini Mesh
- 19 GratEX® Micro Mesh
- 21 GratEX® Rectangular Mesh
- 24 GratEX® Heavy Duty Rectangular Mesh
- 26 GratEX® Solid Surface Mesh
- 31 GratEX® Heavy Duty Solid Surface Mesh
- 33 GratEX® Stair Treads
- 35 GratEX® Stair Tread Kits
- 36 GratEX® Fastening Clips and Installation Methods
- 38 GratEX® Fixing Assembly Combinations
- 42 GratEX® Closed Load Bar Charts

MoultrEX®

- 47 MoultrEX® Moultruded Fibreglass Grating
- 49 MoultrEX® Installation Methods and Accessories

GridEX®

- 51 GridEX® Pultruded Fibreglass Grating
- 52 GridEX® I Type Grating
- 57 GridEX® T Type Grating
- 61 GridEX® Bar Type Grating
- 65 GridEX® Stair Treads and Landings
- 66 GridEX® Installation Methods and Accessories

EX-Series®

- 67 P-Series® Phenolic Grating
- 69 Colour Palette
- 71 Grating Grit Grades
- 72 HygiGR8®
- 73 Conductive Grating
- 74 Terminology
- 75 Installation Suggestions & Tools
- 76 Drafting Information & Manufacturing Tolerances
- 77 Embedment Angle
- 78 StormChief®
- 80 Access Hatches, Handles and Hinge Systems
- 81 Elevated Support Systems
- 83 Appendix 1: Load Data Tables
- 84 Appendix 2: Chemical Resistance Guide
- 88 Appendix 3: GratEX® Ordering Codes
- 89 Appendix 4: MoultrEX® Ordering Codes
- 90 Appendix 5: GridEX® Ordering Codes
- 91 Appendix 6a: GratEX® Fasteners Ordering Information
- 92 Appendix 6b: MoultrEX® Fasteners Ordering Information
- 93 Appendix 6c: GridEX® Fasteners Ordering Information

Ex-Series® Grating Key Selection Considerations

Treadwell EX-Series® Fibreglass Reinforced Plastic (FRP) grating products are recommended for areas where physical properties are paramount to design and longevity. Treadwell offers a very extensive range of FRP grating products which incorporates three main product systems. Of these three distinct product ranges, there are key differences which you as a user or specifier need to be aware of. The below information outlines for you the key differences and the ideal scenarios in which each of the different types of grating are to be utilised.

GratEX® Moulded FRP Grating

The perfect solution for areas where excessive amounts of penetrations (i.e. for piping) call for traditional uni-directional spanning products which make it horrendously expensive and inconvenient.

Characteristic/Application	Rating
Bi-directional spanning ability	●●●●●
Uni-directional spanning ability	●●●●●
Chemical Resistance	●●●●●
Impact Resistance	●●●●●
Weight saving vs. metallic grating	●●●●●
Open Area (allowing for air flow & light penetration)	●●●●●
Panel size availability	●●●●●
Pipe penetrations	●●●●●

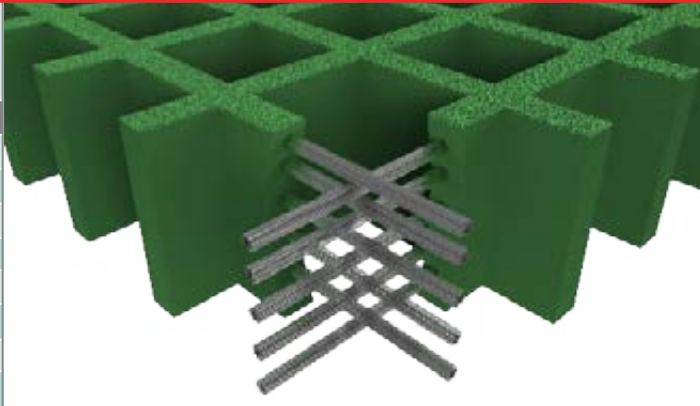

MoultrEX® Moultruded FRP Grating

An excellent product choice for those applications where a medium between great product performance over time and great aesthetics are called for, i.e. jetties, marinas, boardwalks and more!

Characteristic/Application	Rating
Bi-directional spanning ability	●●●●●
Uni-directional spanning ability	●●●●●
Chemical Resistance	●●●●●
Impact Resistance	●●●●●
Weight savings vs. metallic grating	●●●●●
Open Area (allowing for air flow & light penetration)	●●●
Panel size availability	●●
Pipe penetrations	●●●●●

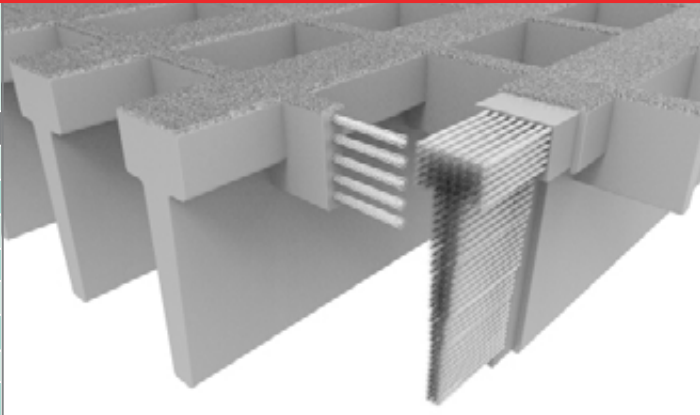





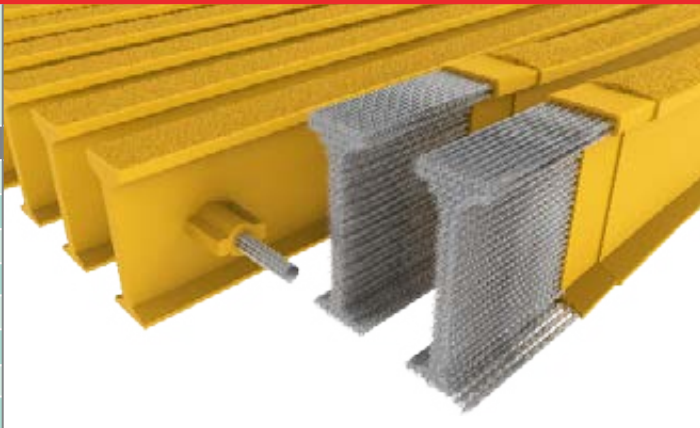

GridEX® Pultruded FRP Grating

The ultimate choice for areas where extremely high loadings, or larger spans present a challenge. Such applications include wide walkways, or where equipment needs to be installed on top of grating.

Characteristic/Application	Rating
Bi-directional spanning ability	●●
Uni-directional spanning ability	●●●●●
Chemical Resistance	●●●●●
Impact Resistance	●●●●●
Weight savings vs. metallic grating	●●●●●
Open Area (allowing for air flow & light penetration)	●●●
Panel size availability	●●●
Pipe penetrations	●●●



Legend	Description	Legend	Description	Legend	Description
	Product is compliant to the Australian Disability Access Code AS 1428.		Product conforms to Australian Standard AS 1657-2013		Product weight per square metre.
	Product is pet friendly. Product is heel safe.		Product conforms to Australian Standard AS 1657-2013, Clause 4.5.		Product conforms to Australian Standard AS 4586 2013. P5 Slip Resistance

EX-Series® Resin Selection Guide



When choosing a resin type for your application, we highly recommend you consult us to ensure that the correct resin is specified. Considerations such as corrosion, environment, temperature, fire resistance, smoke and smoke toxicity requirements must be taken into account, and will dictate which resin system should be utilised for optimum performance over time.

Below is an overview of the resin systems offered in the Access Systems Range.

Options Overview

O-Series™ is an architectural grade polyester resin system with an intermediate level of chemical resistance, and is a good choice for commercial or light industrial applications, especially where moisture is prevalent. O-Series™ is often utilised for public infrastructure applications where it has been proven to outperform traditional timber decking products. This system is manufactured with fire retardant additives.

I-Series™ is a premium isophthalic resin system. This system provides an intermediate level of chemical resistance and is the correct choice for areas subjected to splash and spill contact with harsh chemicals. This system is an excellent general-purpose resin and is a more favourably priced alternative to the vinyl ester system. This system has a flame spread of 25 (Approximately 15) or less.

V-Series™ is a vinyl ester resin system that provides the highest chemical resistance offered in the industry and has been developed for use in environments where FRP products are subject to frequent and direct contact with the harshest of chemicals including a broad range of acids and caustics. This system has a flame spread of 25 (Approximately 15) or less.

P-Series™ is a phenolic resin system that is designed specifically for use where fire resistance, low smoke and low toxic fumes are critical. P-Series™ is typically used in offshore applications and confined spaces where such criteria are an absolute necessity. This system is tested in accordance to ASTM E-84. Various products also conforming to US Coast Guard Approvals, Level 2 and 3, are also offered by Treadwell. This particular resin system has a flame spread rating of 5 and a smoke density rating of 5.

Standards Resin Systems Comparison Chart

	Chemical Resistance	Fire Retardance	Low Smoke	Halogen Free	Temperature Performance
O-Series Polyester	● ● ●	● ● ● ●	—	—	● ● ●
I-Series Isophthalic	● ● ● ● ●	● ● ● ● ●	—	—	● ● ● ●
V-Series Vinyl Ester	● ● ● ● ●	● ● ● ● ●	—	—	● ● ● ● ●
P-Series Phenolic	● ● ● ●	● ● ● ● ●	● ● ● ●	● ● ● ● ●	● ● ● ● ●

GratEX® Moulded Fibreglass Grating

What is GratEX® Moulded Fibreglass Grating

Treadwell's GratEX® Moulded FRP grating is a high strength, single piece construction mesh panel product. Treadwell offers both standard panel sizes as well as the option of custom panels made to order from your drawings, or alternatively, drawings provided by Treadwell's drafting department.

Cost effective GratEX® panels allow for effective on-site fabrication/trimming whilst ensuring that wastage is minimised. Load bearing bars in both directions allow for use without continuous side support and so contribute to cost effectiveness. GratEX® offers all the benefits available with grating made from other materials plus a host of superior benefits unequalled by steel or other metal alternatives.



GratEX® Features and Benefits vs. Traditional Alternatives

	GratEX®	Stainless Steel	Galvanised Steel	Aluminium	Polyurethane
Chemical Resistance	•••••	••••	•	•••	••••
Strength	•••••	•••••	•••••	•••••	•••
Lightweight	•••••	•	•	•••••	•••
Electrical Resistance	•••••	•	•	•	•••••

GratEX® Surface Options

Anti-Slip Surface (Standard). This surface is most commonly used in industrial applications. It is very hard wearing and boasts an extremely effective coefficient of friction (NATA laboratory test report available). Unlike serrated steel, the anti-slip surface does not impact load carrying capacity.

Concave Surface. This is preferred for environments where by-products are commonly caught by serrations, and is hence very often utilised by the food industry. This surface option can also be used for guarding options to allow safe handling/ contact.

Plain Surface. This is a stock option that is widely utilised for guarding and architectural features in a variety of applications. Whilst the aesthetics of the product are improved, the anti-slip properties are not as profound as the other options available.



F-MG13(38/38)S

Isometric View

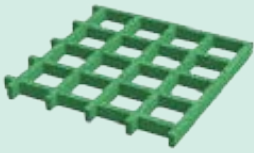

Plan View

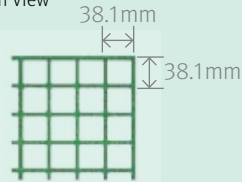

Elevation View

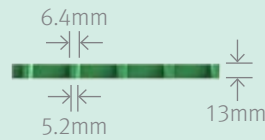

F-MG13(40/40)S

Isometric View

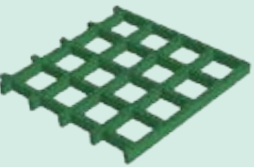

Plan View

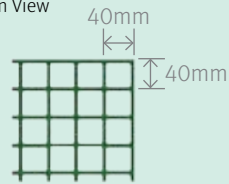

Elevation View

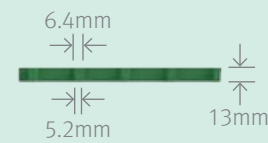

F-MG13(50/50)S

Isometric View

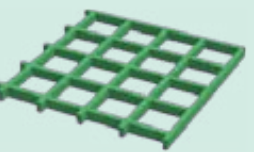

Plan View

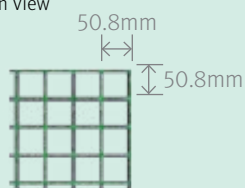

Elevation View

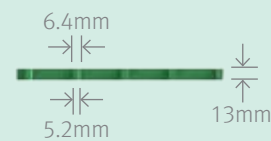

F-MG15(38/38)DS

Isometric View

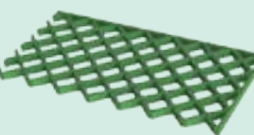

Plan View

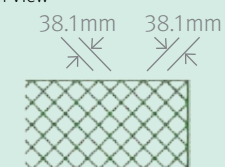

Elevation View

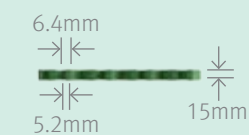

F-MG15(38/38)S

Isometric View

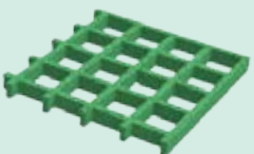

Plan View

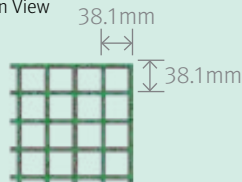

Elevation View

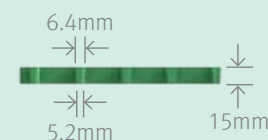

F-MG15(40/40)S

Isometric View

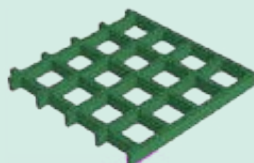



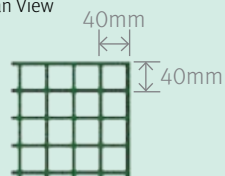



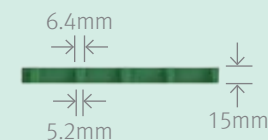



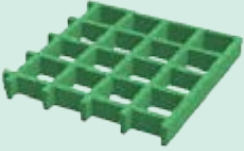
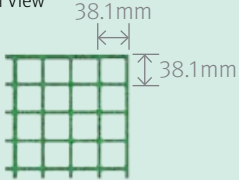
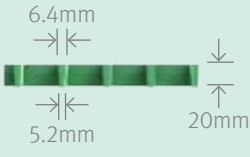

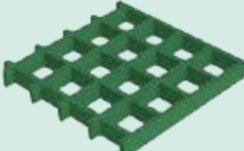
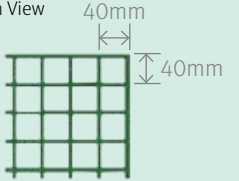
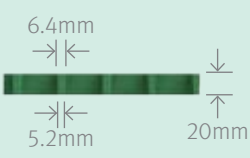
Plan View

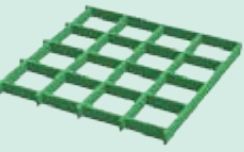
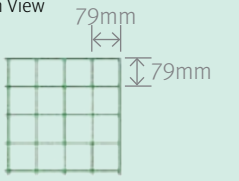
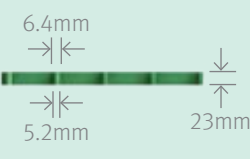

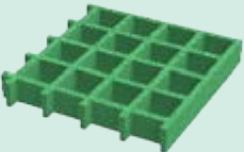
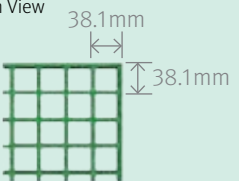
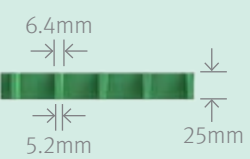
Elevation View

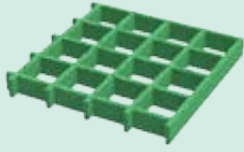
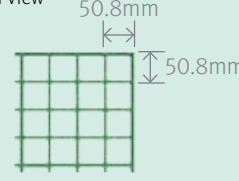
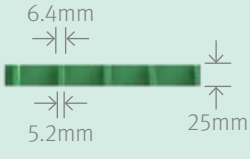

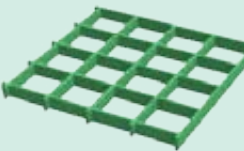
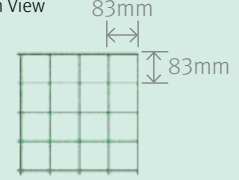
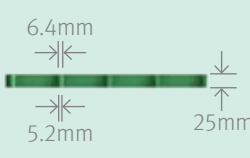
GratEX® Square Mesh

F-MG20(38/38)S			
<p>Isometric View</p> 	<p>Plan View</p> 	<p>Elevation View</p> 	
F-MG20(40/40)S			
<p>Isometric View</p> 	<p>Plan View</p> 	<p>Elevation View</p> 	
F-MG23(79/79)S			
<p>Isometric View</p> 	<p>Plan View</p> 	<p>Elevation View</p> 	
F-MG25(38/38)S			
<p>Isometric View</p> 	<p>Plan View</p> 	<p>Elevation View</p> 	
F-MG25(50/50)S			
<p>Isometric View</p> 	<p>Plan View</p> 	<p>Elevation View</p> 	
F-MG25(83/83)S			
<p>Isometric View</p> 	<p>Plan View</p> 	<p>Elevation View</p> 	

F-MG30(38/38)S

Isometric View

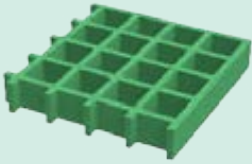

Plan View

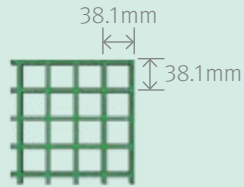

Elevation View

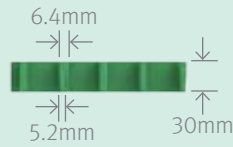

F-MG30(40/40)S

Isometric View

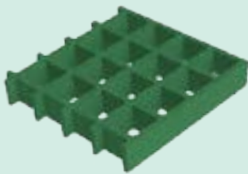

Plan View

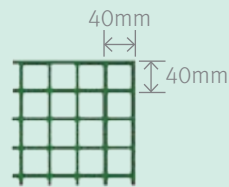

Elevation View

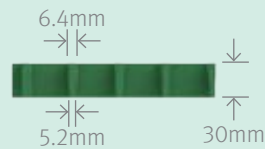

F-MG38(38/38)S

Isometric View

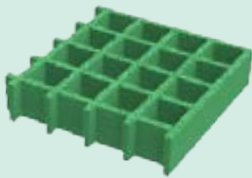

Plan View

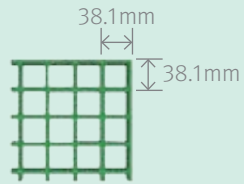

Elevation View

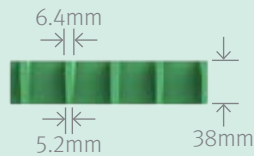

F-MG50(50/50)S

Isometric View



Plan View

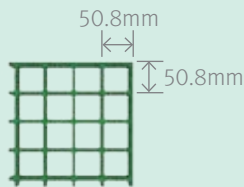

Elevation View

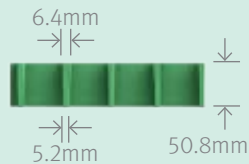

F-MG63(50/50)S

Isometric View



Plan View

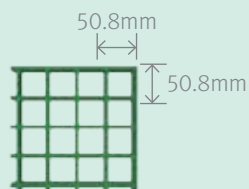

Elevation View

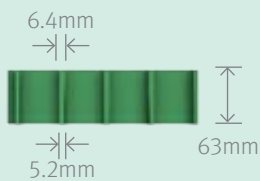

GratEX® Square Mesh

Safe Load & Deflection Charts (mm) - Uniform and Concentrated Line Loads

Mesh Grid	Load Bar Details	Span (mm)	Uniform load – ΔU (kpa/m²) – Deflection (mm) Concentrated line load – ΔC (kN/m) – Deflection (mm)															
			3	5	8	10	15	20	25	30	40	50	60	80	90	100		
FMG25 (38/38)S																		
38X38	25X6	400	ΔU	0.32	0.55	0.87	1.12	1.67	2.23	2.79	3.35	4.46	5.58	6.69	8.93	10.04	11.15	
			ΔC	1.22	2.05	3.27	4.12	6.17	8.23	10.29	12.35	16.46						
		600	ΔU	1.28	2.15	3.43	4.31	6.47	8.63	10.79	12.95	17.26						
			ΔC	3.50	5.85	9.33	11.72	17.57										
		800	ΔU	4.15	6.94	11.09	13.88											
			ΔC	8.30	13.85													
FMG30 (38/38)S																		
38X38	30X6	400	ΔU	0.24	0.42	0.65	0.85	1.26	1.69	2.11	2.54	3.38	4.23	5.07	6.77	7.60	8.44	
			ΔC	0.99	1.67	2.67	3.37	5.04	6.73	8.41	10.10	13.46						
		600	ΔU	0.99	1.67	2.66	3.35	5.02	6.70	8.36	10.04	13.38						
			ΔC	2.72	5.46	7.28	9.13	13.68										
		800	ΔU	3.15	5.28	8.43	10.56											
			ΔC	6.25	10.44													
FMG38 (38/38)S																		
38X38	38X6	400	ΔU	0.12	0.22	0.34	0.45	0.67	0.90	1.12	1.35	1.79	2.25	2.69	3.6	4.04	4.48	
			ΔC	0.62	1.05	1.67	2.12	3.17	4.23	5.29	6.35	8.46	10.58	12.69	16.93	19.04		
		600	ΔU	0.55	0.94	1.49	1.88	2.82	3.77	4.70	5.65	7.52	9.42	11.29	15.07	16.94	18.81	
			ΔC	1.54	2.59	4.13	5.18	7.77	10.37	12.95	15.55							
		800	ΔU	1.69	2.84	4.53	5.68	8.52	11.37	14.2	17.05							
			ΔC	3.28	5.49	8.77	10.98	16.47										
		1000	ΔU	4.16	6.95	11.11	13.92											
			ΔC	6.78	11.32	18.1												
		1200	ΔU	8.76	14.62													
			ΔC	11.58	19.32													
		FMG50 (50/50)S																
		50X50	50X6	400	ΔU	0.08	0.15	0.23	0.32	0.47	0.63	0.79	0.95	1.26	1.58	1.89	2.53	2.84
ΔC	0.31				0.34	0.85	1.08	1.62	2.17	2.70	3.25	4.32	5.42	6.49	8.67	9.74	11.91	
600	ΔU			0.09	0.17	0.25	0.34	0.51	0.69	0.85	1.03	1.36	1.72	2.05	2.75	3.08	3.41	
	ΔC			0.88	1.49	2.37	2.98	4.47	5.97	7.45	8.95	11.92	14.92	17.89				
800	ΔU			0.28	0.49	0.77	0.98	1.47	1.97	2.45	2.95	3.92	4.92	6.49	8.67	8.84	9.81	
	ΔC			1.82	3.05	4.87	6.12	9.17	12.23	15.29	18.35							
1000	ΔU			2.18	3.65	5.83	7.32	10.97	14.63	18.29								
	ΔC			3.62	6.05	9.67	12.12	14.63										
1200	ΔU			4.56	10.1	12.18	12.15											
	ΔC			6.05	13.69	16.15												
1400	ΔU			8.2	16.15													
	ΔC			9.68														

GratEX® Square Mesh Specification

General

1.0 Scope

1.1 The grating shall conform to the material and fabrication requirements as per this specification.

2.0 Standards/Related documents

2.1 The grating system shall conform to the applicable sections of:

- 2.1.1 ASTM E84 Surface Burning Characteristics of Building Materials
- 2.1.2 ASTM D635 Rate of Burning and/or Extent and Time of Burning of Self-Supporting Plastics in a Horizontal Position.

3.0 Design Criteria

- 3.1 The design criteria of the fibreglass products (FRP) shall be in accordance with governing building codes and generally accepted standards in the FRP industry.
- 3.2 Design live loads shall be of ... kPa uniformly distributed load (or as per building code if more stringent) with a maximum deflection of ... mm at the centre of a single span according to product specifications.

4.0 Submittals

- 4.1 Shop drawings of all fabricated grating panels shall be submitted by Treadwell (unless provided by the client) displaying clearly material sizes, types, styles, product codes and including types and sizes of fasteners as well as a layout if required.
- 4.2 Technical data and sample pieces can also be submitted if required.

5.0 Quality Assurance

Quality surrounds every aspect of Treadwell's commitment to our superior products and efficiency. Treadwell's quality assurance strictly adheres to the high quality control standards placed to conform to relevant specifications, codes, Australian Standards and contractual requirements in a timely manner.

6.0 Product Delivery and Storage

- 6.1 All grating and components or ancillary items shall be fabricated as per the design and piece marked to design drawings.
- 6.2 All manufactured materials shall be delivered in unbroken packages.

Product System

7.0 Manufacturing Process

- 7.1 All fibreglass (FRP) items listed under this section shall be constructed from fibreglass reinforcement and resin of the quality necessary to meet the design requirements and dimensions as specified.
- 7.2 Fibreglass reinforcement shall be continuous roving and shall be in sufficient quantities as required for the application.
- 7.3 Resins shall be ... (refer to page 5) with chemical formulations as necessary to provide the corrosion resistance, strength and any other physical properties as required.
- 7.4 All finished surfaces to be smooth, resin-rich, free of voids and without dry spots, cracks or unreinforced areas and all fibreglass reinforcement shall be well covered with resin to protect against exposure due to weather or wear.
- 7.5 All fibreglass (FRP) items shall be EITHER non-fire retardant OR have a tested flame spread rating of 25 or less when tested in accordance with the ASTM E84 Tunnel Test.

- 7.6 Contact Treadwell regarding specification data relative to products conforming to ASTM D635.
- 7.7 All metal accessories shall be manufactured from (304 or 316) Stainless Steel, 2205 Duplex Stainless Steel, 2507 Super Duplex Stainless Steel, hot dipped galvanised steel or aluminium.
- 7.8 Load bars shall be joined with notched cross bars via interlocking methods and the use of chemical bonding.
- 7.9 The fibreglass reinforcement content shall be maintained at 65% (by weight) so as to achieve maximum loading capacity.
- 7.10 All fibreglass material shall have an ultraviolet light inhibiting chemical additive to resist UV degradation.
- 7.11 Grating shall be manufactured with a concave profile on top of each bar OR an anti-slip Aluminium Oxide surface to provide optimum slip resistance.

8.0 Acceptable Manufacturer

The fibreglass underfoot moulded grating system shall be manufactured by Treadwell Group Pty Ltd of Australia.

Ordering Information

Code

1. Nominate the type of grating required	F-MG = GratEX® Moulded Grating
2. Nominate the depth (mm) required	13, 15, 20, 23, 25, 30, 38, 50, 53, 55 and 63
3. Nominate the load bar centres required	(38/38) = 38mm x 38mm (40/40) = 40mm x 40mm (50/50) = 50mm x 50mm (79/79) = 79mm x 79mm (83/83) = 83mm x 83mm
4. Nominate the mesh type required	S = Standard Square Mesh DS = Diagonal Square Mesh

Note: This section of the coding is typically separated from the next section of the coding by a dash (-)

5. Specify the resin, material or type (see page 6)	O = O - Series I = I - Series V = V - Series
6. Specify the colour required <small>*In which instance a code and name of the selected colour must be mentioned within the description.</small>	G = Industrial Green Y = Safety Yellow LG = Light Grey DG = Dark Grey CH = Charcoal C = Custom*
7. Specify the surface style required	CG = Commercial Grade (Grit) Anti-Slip G = Industrial Grade (Grit) Anti-Slip MG = Marine Grade (Grit) Anti-Slip C = Concave P = Plain(Flat)



Note: The next section of coding is separated by a slash (/), it isn't required for custom jobs as GratEX® is available in a variety of size panels to suit applications.

8. Nominate the panel size required	1 = 1225 mm x 3665 mm 2 = 920 mm x 3055 mm
-------------------------------------	---

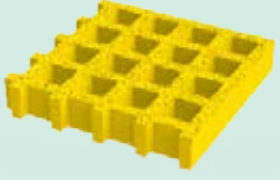
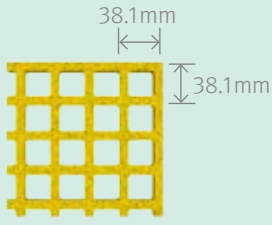
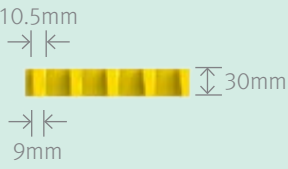

Please refer to Appendix 3: GratEX® Ordering Codes - page 88

GratEX® Heavy Duty Square Mesh

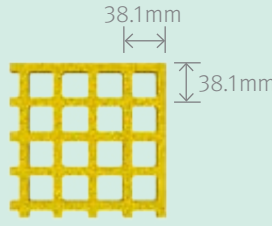
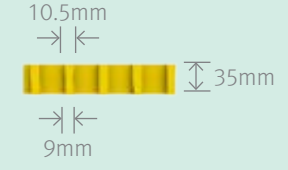

F-MG30(38/38)HDS

<p>Isometric View</p> 	<p>Plan View</p> 	<p>Elevation View</p> 	
---	--	--	---

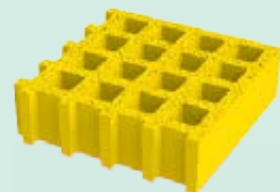
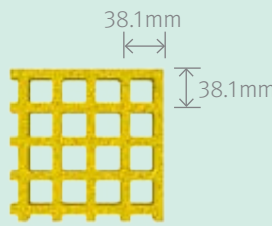
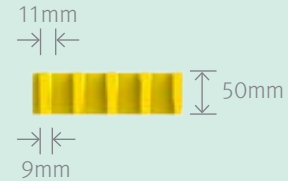

F-MG35(38/38)HDS

<p>Isometric View</p> 	<p>Plan View</p> 	<p>Elevation View</p> 	
--	---	---	--

F-MG50(38/38)HDS

<p>Isometric View</p> 	<p>Plan View</p> 	<p>Elevation View</p> 	
---	--	--	---

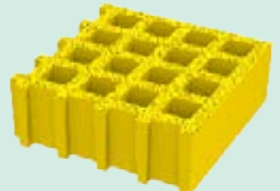
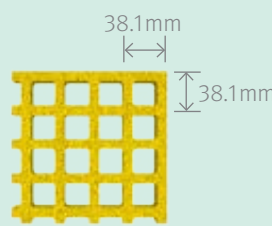
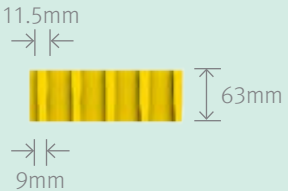
F-MG60(38/38)HDS

<p>Isometric View</p> 	<p>Plan View</p> 	<p>Elevation View</p> 	
---	--	--	---

GratEX® Heavy Duty Square Mesh Specification

General

1.0 Scope

1.1 The grating shall conform to the material and fabrication requirements as per this specification.

2.0 Standards/Related documents

2.1 The grating system shall conform to the applicable sections of:

- 2.1.1 ASTM E84 Surface Burning Characteristics of Building Materials
- 2.1.2 ASTM D635 Rate of Burning and/or Extent and Time of Burning of Self-Supporting Plastics in a Horizontal Position.

3.0 Design Criteria

- 3.1 The design criteria of the fibreglass products (FRP) shall be in accordance with governing building codes and generally accepted standards in the FRP industry.
- 3.2 Design live loads shall be of ... kPa uniformly distributed load (or as per building code if more stringent) with a maximum deflection of ... mm at the centre of a single span according to product specifications.

4.0 Submittals

- 4.1 Shop drawings of all fabricated grating panels shall be submitted by Treadwell (unless provided by the client) displaying clearly material sizes, types, styles, product codes and including types and sizes of fasteners as well as a layout if required.
- 4.2 Technical data and sample pieces can also be submitted if required.

5.0 Quality Assurance

Quality surrounds every aspect of Treadwell's commitment to our superior products and efficiency. Treadwell's quality assurance strictly adheres to the high quality control standards placed to conform to relevant specifications, codes, Australian Standards and contractual requirements in a timely manner.

6.0 Product Delivery and Storage

- 6.1 All grating and components or ancillary items shall be fabricated as per the design and piece marked to design drawings.
- 6.2 All manufactured materials shall be delivered in unbroken packages.

Product System

7.0 Manufacturing Process

- 7.1 All fibreglass (FRP) items listed under this section shall be constructed from fibreglass reinforcement and resin of the quality necessary to meet the design requirements and dimensions as specified.
- 7.2 Fibreglass reinforcement shall be continuous roving and shall be in sufficient quantities as required for the application.
- 7.3 Resins shall be ... (refer to page 5) with chemical formulations as necessary to provide the corrosion resistance, strength and any other physical properties as required.
- 7.4 All finished surfaces to be smooth, resin-rich, free of voids and without dry spots, cracks or unreinforced areas and all fibreglass reinforcement shall be well covered with resin to protect against exposure due to weather or wear.
- 7.5 All fibreglass (FRP) items shall be EITHER non-fire retardant OR have a tested flame spread rating of 25 or less when tested in accordance with the ASTM E84 Tunnel Test.

- 7.6 Contact Treadwell regarding specification data relative to products conforming to ASTM D635.
- 7.7 All metal accessories shall be manufactured from (304 or 316) Stainless Steel, 2205 Duplex Stainless Steel, 2507 Super Duplex Stainless Steel, hot dipped galvanised steel or aluminium.
- 7.8 Load bars shall be joined with notched cross bars via interlocking methods and the use of chemical bonding.
- 7.9 The fibreglass reinforcement content shall be maintained at 65% (by weight) so as to achieve maximum loading capacity.
- 7.10 All fibreglass material shall have an ultraviolet light inhibiting chemical additive to resist UV degradation.
- 7.11 Grating shall be manufactured with a concave profile on top of each bar OR an anti-slip Aluminium Oxide surface to provide optimum slip resistance.

8.0 Acceptable Manufacturer

The fibreglass underfoot moulded grating system shall be manufactured by Treadwell Group Pty Ltd of Australia.

Ordering Information

Code

- | | |
|---|--------------------------------|
| 1. Nominate the type of grating required | F-MG = GratEX® Moulded Grating |
| 2. Nominate the depth (mm) required | 30, 35, 50 and 60 |
| 3. Nominate the load bar centres required | (38/38) = 38mm x 38mm |
| 4. Nominate the mesh type required | HDS = Heavy Duty Square Mesh |

Note: This section of the coding is typically separated from the next section of the coding by a dash (-)









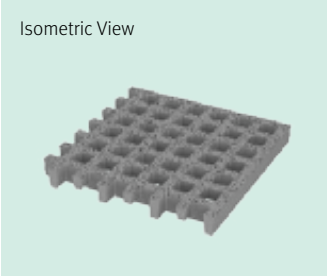
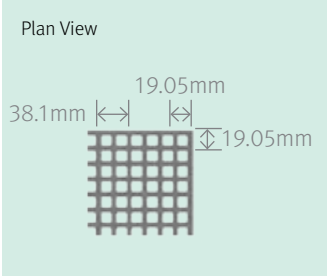
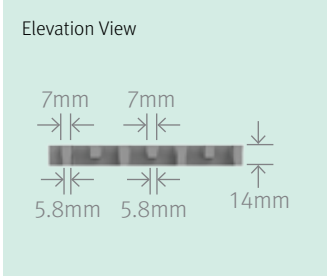

- | | |
|---|---|
| 5. Specify the resin, material or type (see page 6) | O = O- Series
I = I- Series
V = V- Series |
| 6. Specify the colour required | G = Industrial Green
Y = Safety Yellow
LG = Light Grey
DG = Dark Grey
CH = Charcoal
C = Custom* |
| 7. Specify the surface style required | CG = Commercial Grade (Grit) Anti-Slip
G = Industrial Grade (Grit) Anti-Slip
MG = Marine Grade (Grit) Anti-Slip
C = Concave
P = Plain(Flat) |

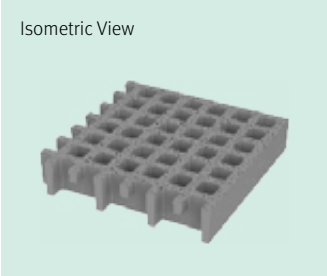
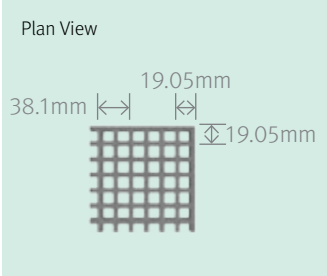
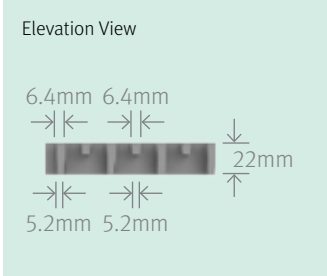
Note: The next section of coding is separated by a slash (/), it isn't required for custom jobs as GratEX® is available in a variety of size panels to suit applications.

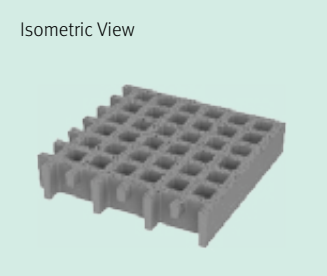
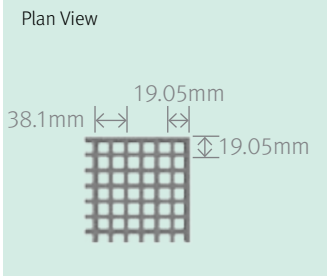
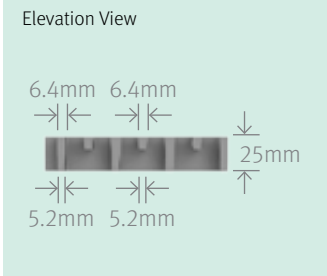

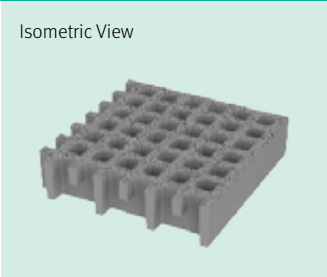
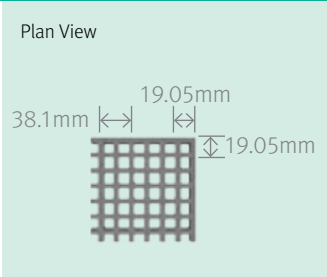
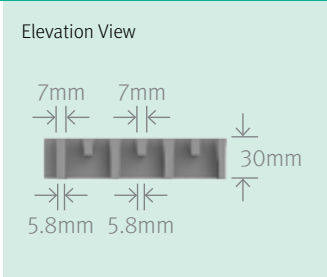
- | | |
|-------------------------------------|---|
| 8. Nominate the panel size required | 1 = 1225 mm x 3665 mm
2 = 920 mm x 3055 mm |
|-------------------------------------|---|

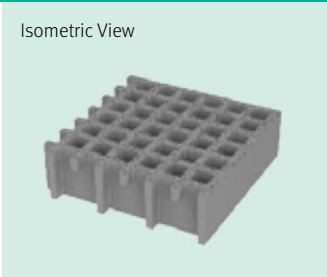
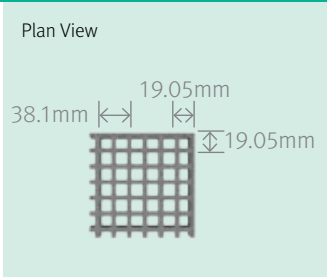
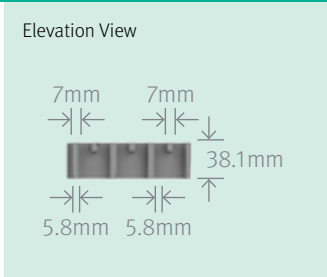
Please refer to Appendix 3: GratEX® Ordering Codes - page 88

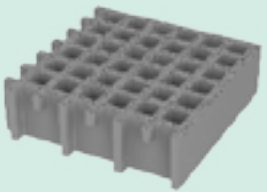
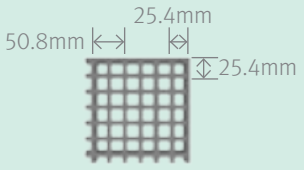
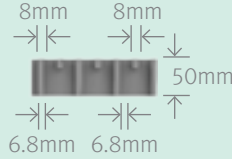

GratEX® Mini Mesh

F-MG14(19/19)M			
<p>Isometric View</p> 	<p>Plan View</p> 	<p>Elevation View</p> 	
F-MG22(19/19)M			
<p>Isometric View</p> 	<p>Plan View</p> 	<p>Elevation View</p> 	
F-MG25(19/19)M			
<p>Isometric View</p> 	<p>Plan View</p> 	<p>Elevation View</p> 	
F-MG30(19/19)M			
<p>Isometric View</p> 	<p>Plan View</p> 	<p>Elevation View</p> 	
F-MG38(19/19)M			
<p>Isometric View</p> 	<p>Plan View</p> 	<p>Elevation View</p> 	

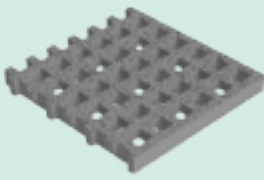
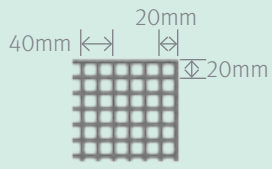
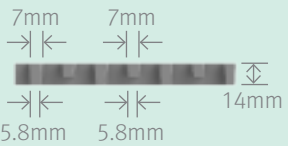

F-MG50(25/25)M

<p>Isometric View</p> 	<p>Plan View</p> 	<p>Elevation View</p> 	
---	--	--	---

F-MG14(20/20)M

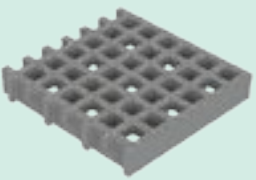
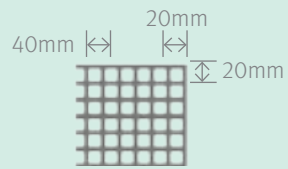
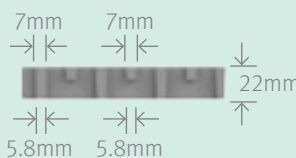

<p>Isometric View</p> 	<p>Plan View</p> 	<p>Elevation View</p> 	
---	--	--	---

F-MG22(20/20)M

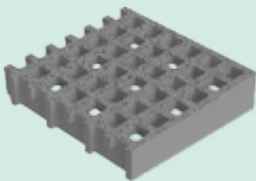
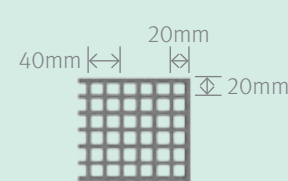
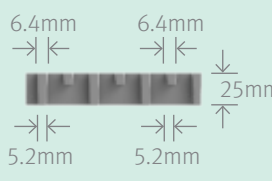

<p>Isometric View</p> 	<p>Plan View</p> 	<p>Elevation View</p> 	
---	--	--	---

GratEX® Mini Mesh

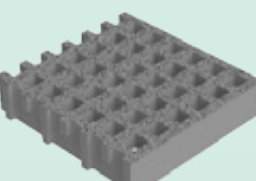
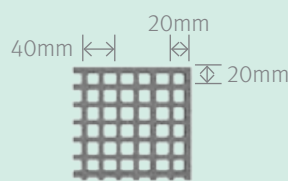
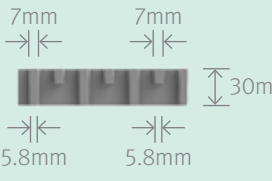

F-MG25(20/20)M

<p>Isometric View</p> 	<p>Plan View</p> 	<p>Elevation View</p> 	
---	--	--	---

F-MG30(20/20)M

<p>Isometric View</p> 	<p>Plan View</p> 	<p>Elevation View</p> 	
---	--	--	---

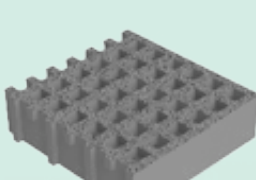
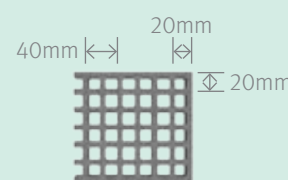
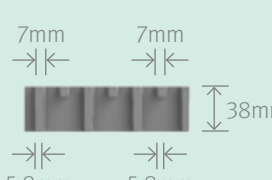
F-MG38(20/20)M

<p>Isometric View</p> 	<p>Plan View</p> 	<p>Elevation View</p> 	
---	--	--	---

Safe Load & Deflection Charts (mm) - Uniform and Concentrated Line Loads

Mesh Grid	Load Bar Details	Span (mm)	Uniform load – ΔU (kpa/m²) – Deflection (mm) Concentrated line load – ΔC (kN/m) – Deflection (mm)													
			3	5	8	10	15	20	25	30	40	50	60	80	90	100

FMG30(19/19)M																		
38x38/ 19x19	32/12.5 x7	400	ΔU	0.19	0.33	0.52	0.68	1.01	1.35	1.69	2.03	3.38	3.38	4.05	5.41	6.08	6.75	
			ΔC	0.79	1.34	2.13	2.70	4.03	5.38	6.73	8.08	10.77						
		600	ΔU	0.79	1.33	2.13	2.68	4.01	5.36	6.69	8.04	10.70						
			ΔC	2.18	3.65	5.82	7.30	10.95										
		800	ΔU	2.52	4.44	6.75	8.45											
			ΔC	5.00	8.35													

FMG38(19/19)M																		
38x38/ 19x19	38/9 x7	400	ΔU	0.096	0.176	0.272	0.360	0.536	0.720	0.896	1.080	1.432	1.800	2.152	2.880	3.232	3.584	
			ΔC	0.496	0.840	1.336	1.696	2.536	3.384	4.232	5.080	6.768	8.464	10.152	13.544	15.232		
		600	ΔU	0.440	0.752	1.192	1.504	6.216	3.016	3.760	4.520	6.106	7.536	9.032	12.056	13.552	15.048	
			ΔC	1.232	2.072	3.304	4.144	6.816	8.296	10.360	12.440							
		800	ΔU	1.352	2.072	3.624	4.544	13.176	9.096	11.360	13.640							
			ΔC	2.624	4.392	7.016	8.784											
		1000	ΔU	3.328	5.560	8.888	11.136											
			ΔC	5.424	9.056	14.480												
		1200	ΔU	7.008	11.696													
			ΔC	9.264	15.456													

FMG50(25/25)M																		
50x50/25 x25	50x9 12x7	400	ΔU	0.064	0.432	0.184	0.256	0.38	0.504	0.632	0.760	1.008	1.264	1.512	2.024	2.272	2.520	
			ΔC	0.248	0.432	0.680	0.864	1.30	1.736	2.160	2.600	3.456	4.336	5.192	6.936	7.792	9.528	
		600	ΔU	0.720	0.136	0.200	0.272	0.41	0.552	0.680	0.824	1.088	1.376	1.640	2.200	2.464	2.728	
			ΔC	0.704	1.192	1.896	2.384	3.58	4.776	5.960	7.160	9.536	11.936	12.312				
		800	ΔU	0.224	0.392	0.616	0.784	1.18	1.576	1.960	2.360	3.136	3.936	4.712	6.296	2.072	7.848	
			ΔC	1.456	2.440	3.896	4.896	7.34	9.784	12.232	14.680							
		1000	ΔU	1.744	2.920	4.664	5.856	8.78	11.704	14.632								
			ΔC	2.896	4.840	7.734	9.696	14.54										
		1200	ΔU	3.648	6.096	9.744	12.200											
			ΔC	4.840	8.080	12.920												
		1400	ΔU	6.560	10.952													
			ΔC	7.744	12.920													

GratEX® Mini Mesh Specification

General

1.0 Scope

1.1 The grating shall conform to the material and fabrication requirements as per this specification.

2.0 Standards/Related documents

2.1 The grating system shall conform to the applicable sections of:

- 2.1.1 ASTM E84 Surface Burning Characteristics of Building Materials
- 2.1.2 ASTM D635 Rate of Burning and/or Extent and Time of Burning of Self-Supporting Plastics in a Horizontal Position.

3.0 Design Criteria

- 3.1 The design criteria of the fibreglass products (FRP) shall be in accordance with governing building codes and generally accepted standards in the FRP industry.
- 3.2 Design live loads shall be of ... kPa uniformly distributed load (or as per building code if more stringent) with a maximum deflection of ... mm at the centre of a single span according to product specifications.

4.0 Submittals

- 4.1 Shop drawings of all fabricated grating panels shall be submitted by Treadwell (unless provided by the client) displaying clearly material sizes, types, styles, product codes and including types and sizes of fasteners as well as a layout if required.
- 4.2 Technical data and sample pieces can also be submitted if required.

5.0 Quality Assurance

Quality surrounds every aspect of Treadwell's commitment to our superior products and efficiency. Treadwell's quality assurance strictly adheres to the high quality control standards placed to conform to relevant specifications, codes, Australian Standards and contractual requirements in a timely manner.

6.0 Product Delivery and Storage

- 6.1 All grating and components or ancillary items shall be fabricated as per the design and piece marked to design drawings.
- 6.2 All manufactured materials shall be delivered in unbroken packages.

Product System

7.0 Manufacturing Process

- 7.1 All fibreglass (FRP) items listed under this section shall be constructed from fibreglass reinforcement and resin of the quality necessary to meet the design requirements and dimensions as specified.
- 7.2 Fibreglass reinforcement shall be continuous roving and shall be in sufficient quantities as required for the application.
- 7.3 Resins shall be ... (refer to page 5) with chemical formulations as necessary to provide the corrosion resistance, strength and any other physical properties as required.
- 7.4 All finished surfaces to be smooth, resin-rich, free of voids and without dry spots, cracks or unreinforced areas and all fibreglass reinforcement shall be well covered with resin to protect against exposure due to weather or wear.
- 7.5 All fibreglass (FRP) items shall be EITHER non-fire retardant OR have a tested flame spread rating of 25 or less when tested in accordance with the ASTM E84 Tunnel Test.

- 7.6 Contact Treadwell regarding specification data relative to products conforming to ASTM D635.
- 7.7 All metal accessories shall be manufactured from (304 or 316) Stainless Steel, 2205 Duplex Stainless Steel, 2507 Super Duplex Stainless Steel, hot dipped galvanised steel or aluminium.
- 7.8 Load bars shall be joined with notched cross bars via interlocking methods and the use of chemical bonding.
- 7.9 The fibreglass reinforcement content shall be maintained at 65% (by weight) so as to achieve maximum loading capacity.
- 7.10 All fibreglass material shall have an ultraviolet light inhibiting chemical additive to resist UV degradation.
- 7.11 Grating shall be manufactured with a concave profile on top of each bar OR an anti-slip Aluminium Oxide surface to provide optimum slip resistance.

8.0 Acceptable Manufacturer

The fibreglass underfoot moulded grating system shall be manufactured by Treadwell Group Pty Ltd of Australia.

Ordering Information

Code

- | | |
|---|--|
| 1. Nominate the type of grating required | F-MG = GratEX® Moulded Grating |
| 2. Nominate the depth (mm) required | 25, 30, 38 and 50 |
| 3. Nominate the load bar centres required | (14 / 14) = 14mm x 14mm
(19 / 19) = 19mm x 19mm
(20 / 20) = 20mm x 20mm
(25 / 25) = 25mm x 25mm |
| 4. Nominate the mesh type required | M = Mini Mesh |

Note: This section of the coding is typically separated from the next section of the coding by a dash (-)

- | | |
|---|--|
| 5. Specify the resin, material or type (see page 6) | O = O- Series
I = I- Series
V = V- Series |
| 6. Specify the colour required | G = Industrial Green
Y = Safety Yellow
LG = Light Grey
DG = Dark Grey
CH = Charcoal
C = Custom* |

- | | |
|---------------------------------------|---|
| 7. Specify the surface style required | CG = Commercial Grade (Grit) Anti-Slip
G = Industrial Grade (Grit) Anti-Slip
MG = Marine Grade (Grit) Anti-Slip
C = Concave
P = Plain(Flat) |
|---------------------------------------|---|

Note: The next section of coding is separated by a slash (/), it isn't required for custom jobs as GratEX® is available in a variety of size panels to suit applications.

- | | |
|-------------------------------------|---|
| 8. Nominate the panel size required | 1 = 1225 mm x 3665 mm
2 = 920 mm x 3055 mm |
|-------------------------------------|---|

Please refer to Appendix 3: GratEX® Ordering Codes - page 88

F-MG25(13/13)MM

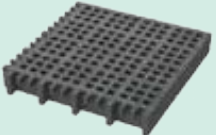
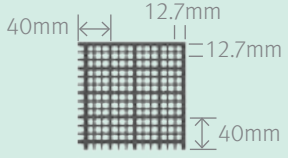
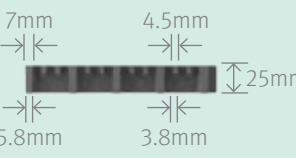
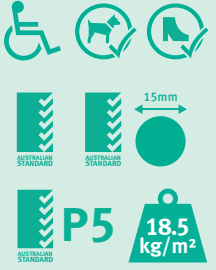
<p>Isometric View</p> 	<p>Plan View</p> 	<p>Elevation View</p> 	
---	--	--	---

F-MG30(13/13)MM

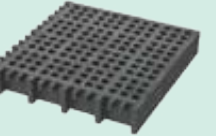
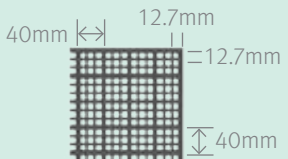
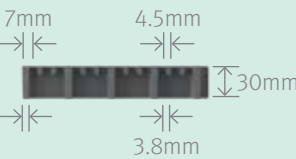
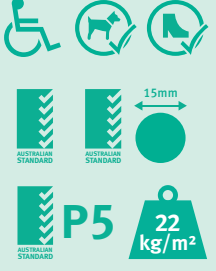
<p>Isometric View</p> 	<p>Plan View</p> 	<p>Elevation View</p> 	
---	--	--	---

F-MG38(13/13)MM

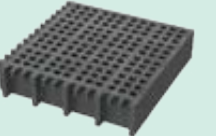
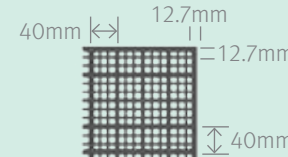
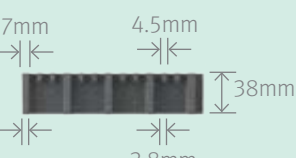
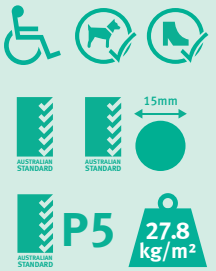
<p>Isometric View</p> 	<p>Plan View</p> 	<p>Elevation View</p> 	
---	--	--	---

GratEX® Micro Mesh Specification

General

1.0 Scope

1.1 The grating shall conform to the material and fabrication requirements as per this specification.

2.0 Standards/Related documents

2.1 The grating system shall conform to the applicable sections of:

- 2.1.1 ASTM E84 Surface Burning Characteristics of Building Materials
- 2.1.2 ASTM D635 Rate of Burning and/or Extent and Time of Burning of Self-Supporting Plastics in a Horizontal Position.

3.0 Design Criteria

- 3.1 The design criteria of the fibreglass products (FRP) shall be in accordance with governing building codes and generally accepted standards in the FRP industry.
- 3.2 Design live loads shall be of ... kPa uniformly distributed load (or as per building code if more stringent) with a maximum deflection of ... mm at the centre of a single span according to product specifications.

4.0 Submittals

- 4.1 Shop drawings of all fabricated grating panels shall be submitted by Treadwell (unless provided by the client) displaying clearly material sizes, types, styles, product codes and including types and sizes of fasteners as well as a layout if required.
- 4.2 Technical data and sample pieces can also be submitted if required.

5.0 Quality Assurance

Quality surrounds every aspect of Treadwell's commitment to our superior products and efficiency. Treadwell's quality assurance strictly adheres to the high quality control standards placed to conform to relevant specifications, codes, Australian Standards and contractual requirements in a timely manner.

6.0 Product Delivery and Storage

- 6.1 All grating and components or ancillary items shall be fabricated as per the design and piece marked to design drawings.
- 6.2 All manufactured materials shall be delivered in unbroken packages.

Product System

7.0 Manufacturing Process

- 7.1 All fibreglass (FRP) items listed under this section shall be constructed from fibreglass reinforcement and resin of the quality necessary to meet the design requirements and dimensions as specified.
- 7.2 Fibreglass reinforcement shall be continuous roving and shall be in sufficient quantities as required for the application.
- 7.3 Resins shall be ... (refer to page 5) with chemical formulations as necessary to provide the corrosion resistance, strength and any other physical properties as required.
- 7.4 All finished surfaces to be smooth, resin-rich, free of voids and without dry spots, cracks or unreinforced areas and all fibreglass reinforcement shall be well covered with resin to protect against exposure due to weather or wear.
- 7.5 All fibreglass (FRP) items shall be EITHER non-fire retardant OR have a tested flame spread rating of 25 or less when tested in accordance with the ASTM E84 Tunnel Test.

- 7.6 Contact Treadwell regarding specification data relative to products conforming to ASTM D635.
- 7.7 All metal accessories shall be manufactured from (304 or 316) Stainless Steel, 2205 Duplex Stainless Steel, 2507 Super Duplex Stainless Steel, hot dipped galvanised steel or aluminium.
- 7.8 Load bars shall be joined with notched cross bars via interlocking methods and the use of chemical bonding.
- 7.9 The fibreglass reinforcement content shall be maintained at 65% (by weight) so as to achieve maximum loading capacity.
- 7.10 All fibreglass material shall have an ultraviolet light inhibiting chemical additive to resist UV degradation.
- 7.11 Grating shall be manufactured with a concave profile on top of each bar OR an anti-slip Aluminium Oxide surface to provide optimum slip resistance.

8.0 Acceptable Manufacturer

The fibreglass underfoot moulded grating system shall be manufactured by Treadwell Group Pty Ltd of Australia.

Ordering Information

Code

- | | |
|---|--------------------------------|
| 1. Nominate the type of grating required | F-MG = GratEX® Moulded Grating |
| 2. Nominate the depth (mm) required | 25, 30 and 38 |
| 3. Nominate the load bar centres required | (13/13) = 13mm x 13mm |
| 4. Nominate the mesh type required | MM = Micro Mesh |

Note: This section of the coding is typically separated from the next section of the coding by a dash (-)

- | | |
|---|---|
| 5. Specify the resin, material or type (see page 6) | O = O- Series
I = I- Series
V = V- Series |
| 6. Specify the colour required
*In which instance a code and name of the selected colour must be mentioned within the description. | G = Industrial Green
Y = Safety Yellow
LG = Light Grey
DG = Dark Grey
CH = Charcoal
C = Custom* |
| 7. Specify the surface style required | CG = Commercial Grade (Grit) Anti-Slip
G = Industrial Grade (Grit) Anti-Slip
MG = Marine Grade (Grit) Anti-Slip
C = Concave
P = Plain(Flat) |

Note: The next section of coding is separated by a slash (/), it isn't required for custom jobs as GratEX® is available in a variety of size panels to suit applications.

- | | |
|-------------------------------------|---|
| 8. Nominate the panel size required | 1 = 1225 mm x 3665 mm
2 = 920 mm x 3055 mm |
|-------------------------------------|---|

Please refer to Appendix 3: GratEX® Ordering Codes - page 88

GratEX® Rectangular Mesh

F-MG25(25/100)R

Isometric View

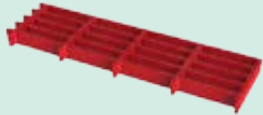

Plan View

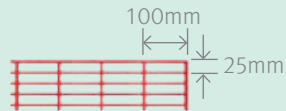

Elevation View

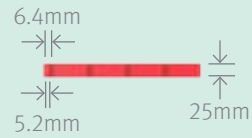

F-MG30(25/100)R

Isometric View

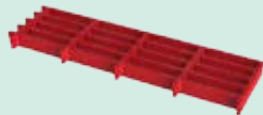

Plan View

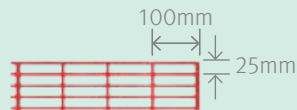

Elevation View



F-MG38(25/100)R

Isometric View

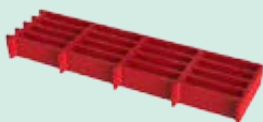

Plan View

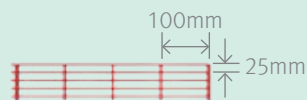

Elevation View



GratEX® Rectangular Mesh

F-MG38(25/152)R

Isometric View



Plan View

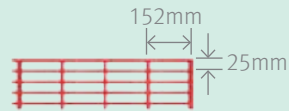

Elevation View

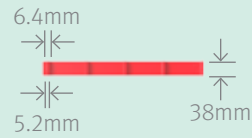

F-MG38(38/100)R

Isometric View

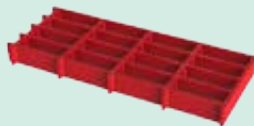

Plan View

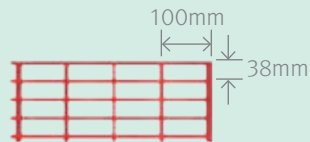

Elevation View

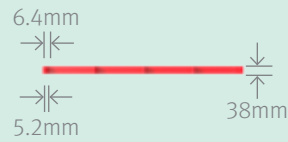

F-MG38(60/220)R

Isometric View



Plan View

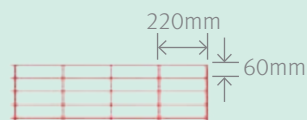

Elevation View

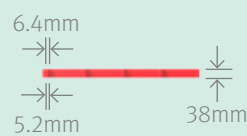

GratEX® Rectangular Mesh Specification

General

1.0 Scope

1.1 The grating shall conform to the material and fabrication requirements as per this specification.

2.0 Standards/Related documents

2.1 The grating system shall conform to the applicable sections of:

- 2.1.1 ASTM E84 Surface Burning Characteristics of Building Materials
- 2.1.2 ASTM D635 Rate of Burning and/or Extent and Time of Burning of Self-Supporting Plastics in a Horizontal Position.

3.0 Design Criteria

- 3.1 The design criteria of the fibreglass products (FRP) shall be in accordance with governing building codes and generally accepted standards in the FRP industry.
- 3.2 Design live loads shall be of ... kPa uniformly distributed load (or as per building code if more stringent) with a maximum deflection of ... mm at the centre of a single span according to product specifications.

4.0 Submittals

- 4.1 Shop drawings of all fabricated grating panels shall be submitted by Treadwell (unless provided by the client) displaying clearly material sizes, types, styles, product codes and including types and sizes of fasteners as well as a layout if required.
- 4.2 Technical data and sample pieces can also be submitted if required.

5.0 Quality Assurance

Quality surrounds every aspect of Treadwell's commitment to our superior products and efficiency. Treadwell's quality assurance strictly adheres to the high quality control standards placed to conform to relevant specifications, codes, Australian Standards and contractual requirements in a timely manner.

6.0 Product Delivery and Storage

- 6.1 All grating and components or ancillary items shall be fabricated as per the design and piece marked to design drawings.
- 6.2 All manufactured materials shall be delivered in unbroken packages.

Product System

7.0 Manufacturing Process

- 7.1 All fibreglass (FRP) items listed under this section shall be constructed from fibreglass reinforcement and resin of the quality necessary to meet the design requirements and dimensions as specified.
- 7.2 Fibreglass reinforcement shall be continuous roving and shall be in sufficient quantities as required for the application.
- 7.3 Resins shall be ... (refer to page 5) with chemical formulations as necessary to provide the corrosion resistance, strength and any other physical properties as required.
- 7.4 All finished surfaces to be smooth, resin-rich, free of voids and without dry spots, cracks or unreinforced areas and all fibreglass reinforcement shall be well covered with resin to protect against exposure due to weather or wear.
- 7.5 All fibreglass (FRP) items shall be EITHER non-fire retardant OR have a tested flame spread rating of 25 or less when tested in accordance with the ASTM E84 Tunnel Test.

- 7.6 Contact Treadwell regarding specification data relative to products conforming to ASTM D635.
- 7.7 All metal accessories shall be manufactured from (304 or 316) Stainless Steel, 2205 Duplex Stainless Steel, 2507 Super Duplex Stainless Steel, hot dipped galvanised steel or aluminium.
- 7.8 Load bars shall be joined with notched cross bars via interlocking methods and the use of chemical bonding.
- 7.9 The fibreglass reinforcement content shall be maintained at 65% (by weight) so as to achieve maximum loading capacity.
- 7.10 All fibreglass material shall have an ultraviolet light inhibiting chemical additive to resist UV degradation.
- 7.11 Grating shall be manufactured with a concave profile on top of each bar OR an anti-slip Aluminium Oxide surface to provide optimum slip resistance.

8.0 Acceptable Manufacturer

The fibreglass underfoot moulded grating system shall be manufactured by Treadwell Group Pty Ltd of Australia.

Ordering Information

Code

- | | |
|---|---|
| 1. Nominate the type of grating required | F-MG = GratEX® Moulded Grating |
| 2. Nominate the depth (mm) required | 25, 30 and 38 |
| 3. Nominate the load bar centres required | (25/100) = 25mm x 100mm
(38/100) = 38mm x 100mm
(25/152) = 25mm x 152mm
(38/152) = 38mm x 152mm
(60/220) = 60mm x 220mm |

- | | |
|------------------------------------|-------------------------------|
| 4. Nominate the mesh type required | R = Standard Rectangular Mesh |
|------------------------------------|-------------------------------|

Note: This section of the coding is typically separated from the next section of the coding by a dash (-)

- | | |
|--|--|
| 5. Specify the resin, material or type (see page 6) | O = O- Series
I = I- Series
V = V- Series |
| 6. Specify the colour required
<small>*In which instance a code and name of the selected colour must be mentioned within the description.</small> | G = Industrial Green
Y = Safety Yellow
LG = Light Grey
DG = Dark Grey
CH = Charcoal
C = Custom* |

- | | |
|---------------------------------------|---|
| 7. Specify the surface style required | CG = Commercial Grade (Grit) Anti-Slip
G = Industrial Grade (Grit) Anti-Slip
MG = Marine Grade (Grit) Anti-Slip
C = Concave
P = Plain(Flat) |
|---------------------------------------|---|



Note: The next section of coding is separated by a slash (/), it isn't required for custom jobs as GratEX® is available in a variety of size panels to suit applications.

- | | |
|-------------------------------------|---|
| 8. Nominate the panel size required | 1 = 1225 mm x 3665 mm
2 = 920 mm x 3055 mm |
|-------------------------------------|---|

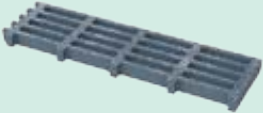
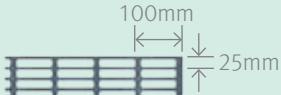
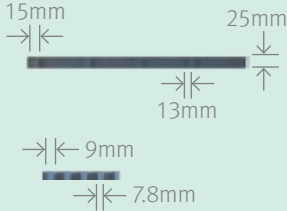

Please refer to Appendix 3: GratEX® Ordering Codes - page 88

GratEX® Heavy Duty Rectangular Mesh

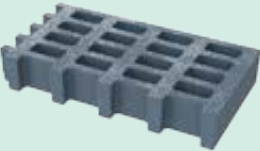
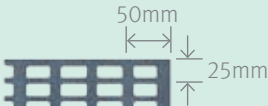
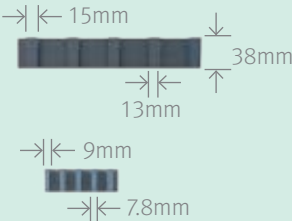

F-MG25(25/100)HDR

<p>Isometric View</p> 	<p>Plan View</p> 	<p>Elevation View</p> 	
---	--	--	---

F-MG38(25/50)HDR

<p>Isometric View</p> 	<p>Plan View</p> 	<p>Elevation View</p> 	
---	--	--	---

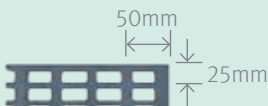
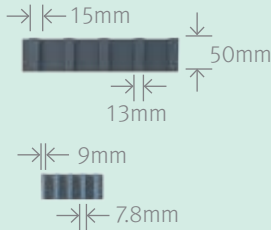
F-MG50(25/50)HDR

<p>Isometric View</p> 	<p>Plan View</p> 	<p>Elevation View</p> 	
---	--	--	---

GratEX® Heavy Duty Rectangular Mesh Specification

General

1.0 Scope

1.1 The grating shall conform to the material and fabrication requirements as per this specification.

2.0 Standards/Related documents

2.1 The grating system shall conform to the applicable sections of:

- 2.1.1 ASTM E84 Surface Burning Characteristics of Building Materials
- 2.1.2 ASTM D635 Rate of Burning and/or Extent and Time of Burning of Self-Supporting Plastics in a Horizontal Position.

3.0 Design Criteria

- 3.1 The design criteria of the fibreglass products (FRP) shall be in accordance with governing building codes and generally accepted standards in the FRP industry.
- 3.2 Design live loads shall be of ... kPa uniformly distributed load (or as per building code if more stringent) with a maximum deflection of ... mm at the centre of a single span according to product specifications.

4.0 Submittals

- 4.1 Shop drawings of all fabricated grating panels shall be submitted by Treadwell (unless provided by the client) displaying clearly material sizes, types, styles, product codes and including types and sizes of fasteners as well as a layout if required.
- 4.2 Technical data and sample pieces can also be submitted if required.

5.0 Quality Assurance

Quality surrounds every aspect of Treadwell's commitment to our superior products and efficiency. Treadwell's quality assurance strictly adheres to the high quality control standards placed to conform to relevant specifications, codes, Australian Standards and contractual requirements in a timely manner.

6.0 Product Delivery and Storage

- 6.1 All grating and components or ancillary items shall be fabricated as per the design and piece marked to design drawings.
- 6.2 All manufactured materials shall be delivered in unbroken packages.

Product System

7.0 Manufacturing Process

- 7.1 All fibreglass (FRP) items listed under this section shall be constructed from fibreglass reinforcement and resin of the quality necessary to meet the design requirements and dimensions as specified.
- 7.2 Fibreglass reinforcement shall be continuous roving and shall be in sufficient quantities as required for the application.
- 7.3 Resins shall be ... (refer to page 5) with chemical formulations as necessary to provide the corrosion resistance, strength and any other physical properties as required.
- 7.4 All finished surfaces to be smooth, resin-rich, free of voids and without dry spots, cracks or unreinforced areas and all fibreglass reinforcement shall be well covered with resin to protect against exposure due to weather or wear.
- 7.5 All fibreglass (FRP) items shall be EITHER non-fire retardant OR have a tested flame spread rating of 25 or less when tested in accordance with the ASTM E84 Tunnel Test.

- 7.6 Contact Treadwell regarding specification data relative to products conforming to ASTM D635.
- 7.7 All metal accessories shall be manufactured from (304 or 316) Stainless Steel, 2205 Duplex Stainless Steel, 2507 Super Duplex Stainless Steel, hot dipped galvanised steel or aluminium.
- 7.8 Load bars shall be joined with notched cross bars via interlocking methods and the use of chemical bonding.
- 7.9 The fibreglass reinforcement content shall be maintained at 65% (by weight) so as to achieve maximum loading capacity.
- 7.10 All fibreglass material shall have an ultraviolet light inhibiting chemical additive to resist UV degradation.
- 7.11 Grating shall be manufactured with a concave profile on top of each bar OR an anti-slip Aluminium Oxide surface to provide optimum slip resistance.

8.0 Acceptable Manufacturer

The fibreglass underfoot moulded grating system shall be manufactured by Treadwell Group Pty Ltd of Australia.

Ordering Information

Code

- | | |
|---|--|
| 1. Nominate the type of grating required | F-MG = GratEX® Moulded Grating |
| 2. Nominate the depth (mm) required | 25, 38, and 50 |
| 3. Nominate the load bar centres required | (25/50) = 25mm x 50mm
(25/100) = 25mm x 100mm |
| 4. Nominate the mesh type required | HDR = Heavy Duty Rectangular Mesh |

Note: This section of the coding is typically separated from the next section of the coding by a dash (-)

- | | |
|--|---|
| 5. Specify the resin, material or type (see page 6) | O = O- Series
I = I- Series
V = V- Series |
| 6. Specify the colour required
<small>*In which instance a code and name of the selected colour must be mentioned within the description.</small> | G = Industrial Green
Y = Safety Yellow
LG = Light Grey
DG = Dark Grey
CH = Charcoal
C = Custom* |
| 7. Specify the surface style required | CG = Commercial Grade (Grit) Anti-Slip
G = Industrial Grade (Grit) Anti-Slip
MG = Marine Grade (Grit) Anti-Slip
C = Concave
P = Plain(Flat) |

Note: The next section of coding is separated by a slash (/), it isn't required for custom jobs as GratEX® is available in a variety of size panels to suit applications.

- | | |
|-------------------------------------|---|
| 8. Nominate the panel size required | 1 = 1225 mm x 3665 mm
2 = 920 mm x 3055 mm |
|-------------------------------------|---|

Please refer to Appendix 3: GratEX® Ordering Codes - page 88

GratEX® Solid Surface Mesh

GratEX® Solid Surface Options

Anti-Slip Surface (Standard). This surface is most commonly used in industrial applications. It is very hard-wearing and has an extremely effective coefficient of friction (NATA laboratory test report available). Unlike serrated steel grating, the anti-slip surface does not impact on load carrying capacity.

Chequer Plate Surface. Offers a less aggressive anti-slip flooring solution which does not trap as much dirt or grime as grit types and can be cleaned much easier. These options also offer superior aesthetics compared to other surface finishes.

Diamond Plate. Diamond Plate surface is a popular cover option that offers less traction. It is ideal in environments where grit and grime can be potentially trapped in conventional grating. The diamond pattern is aesthetically pleasing and easy to clean.

Plain Surface. This surface is a non-stock option and is most commonly utilised in applications where a robust and anti-corrosive substrate is required for a primary floor covering. Used commonly in commercial and industrial flooring applications, it successfully provides lightweight and cost-effective solutions.



F-MG20(38/38)(3)F, F-MG20(38/38)(5)F*

<p>Isometric View</p>	<p>Plan View</p>	<p>Elevation View</p>	
-----------------------	------------------	-----------------------	--

F-MG23(79/79)(3)F, F-MG23(79/79)(5)F*

<p>Isometric View</p>	<p>Plan View</p>	<p>Elevation View</p>	
-----------------------	------------------	-----------------------	--

GratEX® Solid Surface Mesh

F-MG25(38/38)(3)F, F-MG25(38/38)(5)F*

Isometric View

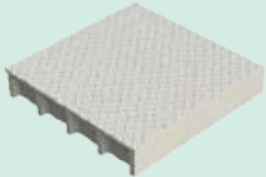

Plan View



Elevation View

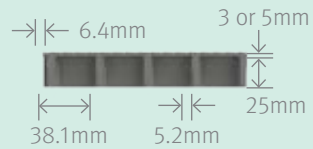

F-MG30(38/38)(3)F, F-MG30(38/38)(5)F*

Isometric View

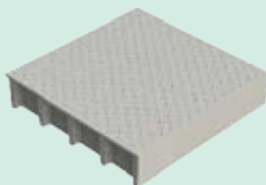

Plan View



Elevation View

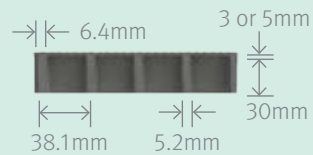

F-MG35(38/38)(3)F, F-MG35(38/38)(5)F*

Isometric View

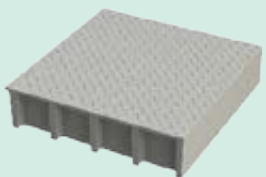

Plan View





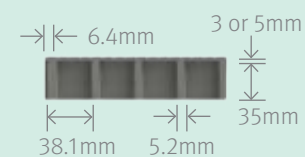

Elevation View





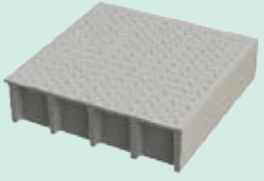

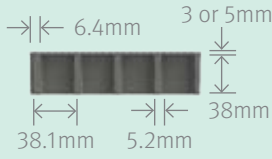
* (3) or (5) refers to the option of a 3mm or 5mm Solid Top. ** All weights are based on 5mm Solid Top.

GratEX® Solid Surface Mesh



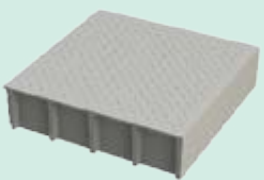

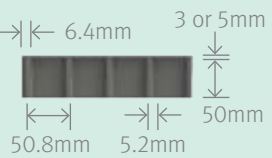
F-MG38(38/38)(3)F, F-MG38(38/38)(5)F*

<p>Isometric View</p> 	<p>Plan View</p> 	<p>Elevation View</p> 	
---	--	--	---

F-MG50(50/50)(3)F, F-MG50(50/50)(5)F*

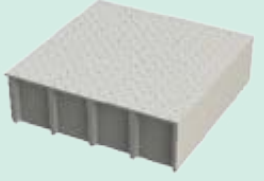
<p>Isometric View</p> 	<p>Plan View</p> 	<p>Elevation View</p> 	
---	--	--	---

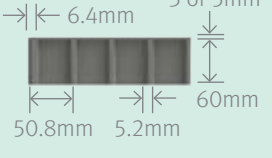
F-MG60(50/50)(3)F, F-MG60(50/50)(5)F*

<p>Isometric View</p> 	<p>Plan View</p> 	<p>Elevation View</p> 	
---	--	--	---

GratEX® Solid Surface Mesh

Safe Load & Deflection Charts (mm) - Uniform and Concentrated Line Loads

Mesh Grid	Load Bar Details	Span (mm)	Uniform load – ΔU (kpa/m²) – Deflection (mm) Concentrated line load – ΔC (kN/m) – Deflection (mm)													
			3	5	8	10	15	20	25	30	40	50	60	80	90	100

FMG25 (38/38)(3) F, FMG25 (38/38)(5) F																		
38x38	25x6	400	ΔU	0.26	0.44	0.70	0.90	1.34	1.78	2.23	2.68	3.57	4.46	5.35	7.14	8.03	8.92	
			ΔC	0.98	1.64	2.616	3.30	4.94	6.58	8.23	9.88	13.17						
		600	ΔU	1.02	1.72	2.74	3.46	5.18	6.90	8.63	10.36	13.81						
			ΔC	2.80	4.68	7.48	9.38	14.06										
		800	ΔU	3.32	5.55	8.87	11.10											
			ΔC	6.64	11.08													

FMG38 (38/38)(3) F, FMG38 (38/38)(5) F																		
38x38	38x6	400	ΔU	0.96	0.18	0.27	0.36	0.54	0.72	0.90	1.08	1.43	1.80	2.15	3.23	2.88	3.58	
			ΔC	0.50	0.84	1.34	1.7	2.54	3.38	4.23	5.08	6.77	8.46	10.15	15.53	13.54	15.05	
		600	ΔU	0.44	0.75	1.19	1.5	2.26	3.02	3.76	4.52	6.02	7.54	9.03	12.06	12.06		
			ΔC	1.23	2.07	3.3	4.14	6.22	8.3	10.36	12.44							
		800	ΔU	1.35	2.27	3.62	4.54	6.82	9.1	11.36	13.64							
			ΔC	2.62	4.39	7.02	8.78	13.18										
		1200	ΔU	3.54	5.91	9.44	11.83											
			ΔC	5.76	9.62	15.39												
		1400	ΔU	7.45	12.34													
			ΔC	9.84	16.42													

FMG50 (50/50)(3) F, FMG50 (50/50)(5) F																		
50x50	50x6	400	ΔU	0.06	0.12	0.18	0.26	0.38	0.50	0.63	0.76	1.01	1.26	1.51	2.02	2.27	2.52	
			ΔC	0.25	0.27	0.68	0.86	1.3	1.74	2.16	2.6	3.46	4.34	5.19	6.94	7.79	9.53	
		600	ΔU	0.07	0.14	0.2	0.27	0.41	0.55	0.68	1.03*.8	1.38	1.38	1.64				
			ΔC	0.7	1.19	1.9	2.38	3.58	4.78	5.96	7.16	11.94	11.94	14.31	2.20	2.46	2.73	
		800	ΔU	0.22	0.39	0.62	0.78	1.18	1.58	1.96	2.36	3.94	3.94	4.71	6.30	7.07	7.85	
			ΔC	1.46	2.44	3.9	4.9	7.34	9.78	12.23	14.68							
		1000	ΔU	1.74	2.92	4.66	5.86	8.78	11.70	14.63								
			ΔC	2.9	4.84	7.74	9.7	14.63										
		1200	ΔU	3.88	6.48	10.35	12.96											
			ΔC	5.14	8.59	13.73												
		1400	ΔU	6.97	11.64													
			ΔC	8.23	13.73													

GratEX® Solid Surface Mesh Specification

General

1.0 Scope

1.1 The grating shall conform to the material and fabrication requirements as per this specification.

2.0 Standards/Related documents

- 2.1 The grating system shall conform to the applicable sections of:
- 2.1.1 ASTM E84 Surface Burning Characteristics of Building Materials
 - 2.1.2 ASTM D635 Rate of Burning and/or Extent and Time of Burning of Self-Supporting Plastics in a Horizontal Position.

3.0 Design Criteria

- 3.1 The design criteria of the fibreglass products (FRP) shall be in accordance with governing building codes and generally accepted standards in the FRP industry.
- 3.2 Design live loads shall be of ... kPa uniformly distributed load (or as per building code if more stringent) with a maximum deflection of ... mm at the centre of a single span according to product specifications.

4.0 Submittals

- 4.1 Shop drawings of all fabricated grating panels shall be submitted by Treadwell (unless provided by the client) displaying clearly material sizes, types, styles, product codes and including types and sizes of fasteners as well as a layout if required.
- 4.2 Technical data and sample pieces can also be submitted if required.

5.0 Quality Assurance

Quality surrounds every aspect of Treadwell's commitment to our superior products and efficiency. Treadwell's quality assurance strictly adheres to the high quality control standards placed to conform to relevant specifications, codes, Australian Standards and contractual requirements in a timely manner.

6.0 Product Delivery and Storage

- 6.1 All grating and components or ancillary items shall be fabricated as per the design and piece marked to design drawings.
- 6.2 All manufactured materials shall be delivered in unbroken packages.

Product System

7.0 Manufacturing Process

- 7.1 All fibreglass (FRP) items listed under this section shall be constructed from fibreglass reinforcement and resin of the quality necessary to meet the design requirements and dimensions as specified.
- 7.2 Fibreglass reinforcement shall be continuous roving and shall be in sufficient quantities as required for the application.
- 7.3 Resins shall be ... (refer to page 5) with chemical formulations as necessary to provide the corrosion resistance, strength and any other physical properties as required.
- 7.4 All finished surfaces to be smooth, resin-rich, free of voids and without dry spots, cracks or unreinforced areas and all fibreglass reinforcement shall be well covered with resin to protect against exposure due to weather or wear.
- 7.5 All fibreglass (FRP) items shall be EITHER non-fire retardant OR have a tested flame spread rating of 25 or less when tested in accordance with the ASTM E84 Tunnel Test.

- 7.6 Contact Treadwell regarding specification data relative to products conforming to ASTM D635.
- 7.7 All metal accessories shall be manufactured from (304 or 316) Stainless Steel, 2205 Duplex Stainless Steel, 2507 Super Duplex Stainless Steel, hot dipped galvanised steel or aluminium.
- 7.8 Load bars shall be joined with notched cross bars via interlocking methods and the use of chemical bonding.
- 7.9 The fibreglass reinforcement content shall be maintained at 65% (by weight) so as to achieve maximum loading capacity.
- 7.10 All fibreglass material shall have an ultraviolet light inhibiting chemical additive to resist UV degradation.
- 7.11 Grating shall be manufactured with a smooth chequer plate, diamond plate or an anti-slip Aluminium Oxide surface to provide optimum slip resistance.

8.0 Acceptable Manufacturer

The fibreglass underfoot moulded grating system shall be manufactured by Treadwell Group Pty Ltd of Australia.

Ordering Information

Code

1. Nominate the type of grating required	F-MG = GratEX® Moulded Grating
2. Nominate the depth (mm) required	20, 25, 35, 38, 50, and 60
3. Nominate the load bar centres required	(38/38) = 38mm x 38mm (50/50) = 50mm x 50mm (79/79) = 79mm x 79mm
4. Nominate thickness solid top that you require	(3) = 3mm (5) = 5mm

Note: This section of the coding is typically separated from the next section of the coding by a dash (-)

5. Specify the mesh type required	F = Solid Surface (Flat) Mesh
6. Specify the resin, material or type (see page 6)	O = O- Series I = I- Series V = V- Series
7. Specify the colour required	G = Industrial Green Y = Safety Yellow LG = Light Grey DG = Dark Grey CH = Charcoal C = Custom*

*In which instance a code and name of the selected colour must be mentioned within the description.

8. Specify the surface style required	CG = Commercial Grade (Grit) Anti-Slip G = Industrial Grade (Grit) Anti-Slip MG = Marine Grade (Grit) Anti-Slip CP = Chequer Plate DP = Diamond Plate P = Plain (Smooth)
---------------------------------------	---

Note: The next section of coding is separated by a slash (/), it isn't required for custom jobs as GratEX® is available in a variety of size panels to suit applications.

9. Nominate the panel size required	1 = 1225 mm x 3665 mm 2 = 920 mm x 3055 mm
-------------------------------------	---

Please refer to Appendix 3: GratEX® Ordering Codes - page 88

GratEX® Heavy Duty Solid Surface Mesh

F-MG30(38/38)(3)HDF, F-MG30(38/38)(5)HDF*

Isometric View

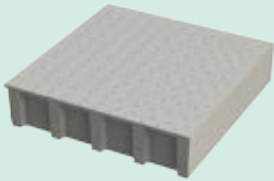

Plan View



Elevation View

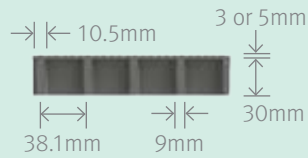

F-MG35(38/38)(3)HDF, F-MG35(38/38)(5)HDF*

Isometric View

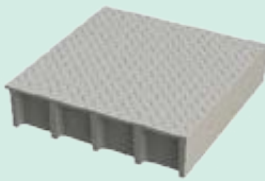

Plan View



Elevation View

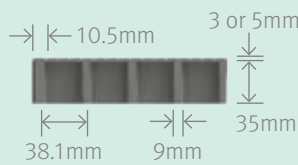

F-MG50(38/38)(3)HDF, F-MG50(38/38)(5)HDF*

Isometric View

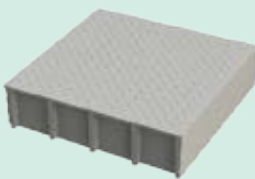

Plan View



Elevation View

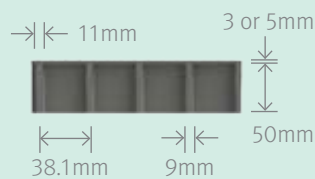

F-MG60(38/38)(3)HDF, F-MG60(38/38)(5)HDF*

Isometric View

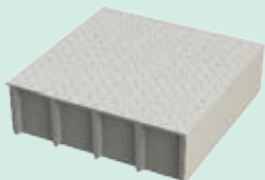

Plan View

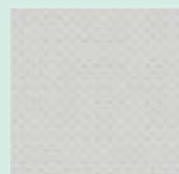

Elevation View

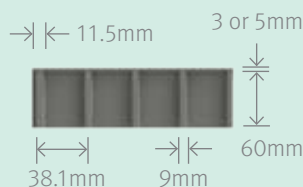

GratEX® Heavy Duty Solid Surface Mesh Specification

General

1.0 Scope

1.1 The grating shall conform to the material and fabrication requirements as per this specification.

2.0 Standards/Related documents

2.1 The grating system shall conform to the applicable sections of:

- 2.1.1 ASTM E84 Surface Burning Characteristics of Building Materials
- 2.1.2 ASTM D635 Rate of Burning and/or Extent and Time of Burning of Self-Supporting Plastics in a Horizontal Position.

3.0 Design Criteria

- 3.1 The design criteria of the fibreglass products (FRP) shall be in accordance with governing building codes and generally accepted standards in the FRP industry.
- 3.2 Design live loads shall be of ... kPa uniformly distributed load (or as per building code if more stringent) with a maximum deflection of ... mm at the centre of a single span according to product specifications.

4.0 Submittals

- 4.1 Shop drawings of all fabricated grating panels shall be submitted by Treadwell (unless provided by the client) displaying clearly material sizes, types, styles, product codes and including types and sizes of fasteners as well as a layout if required.
- 4.2 Technical data and sample pieces can also be submitted if required.

5.0 Quality Assurance

Quality surrounds every aspect of Treadwell's commitment to our superior products and efficiency. Treadwell's quality assurance strictly adheres to the high quality control standards placed to conform to relevant specifications, codes, Australian Standards and contractual requirements in a timely manner.

6.0 Product Delivery and Storage

- 6.1 All grating and components or ancillary items shall be fabricated as per the design and piece marked to design drawings.
- 6.2 All manufactured materials shall be delivered in unbroken packages.

Product System

7.0 Manufacturing Process

- 7.1 All fibreglass (FRP) items listed under this section shall be constructed from fibreglass reinforcement and resin of the quality necessary to meet the design requirements and dimensions as specified.
- 7.2 Fibreglass reinforcement shall be continuous roving and shall be in sufficient quantities as required for the application.
- 7.3 Resins shall be ... (refer to page 5) with chemical formulations as necessary to provide the corrosion resistance, strength and any other physical properties as required.
- 7.4 All finished surfaces to be smooth, resin-rich, free of voids and without dry spots, cracks or unreinforced areas and all fibreglass reinforcement shall be well covered with resin to protect against exposure due to weather or wear.
- 7.5 All fibreglass (FRP) items shall be EITHER non-fire retardant OR have a tested flame spread rating of 25 or less when tested in accordance with the ASTM E84 Tunnel Test.

- 7.6 Contact Treadwell regarding specification data relative to products conforming to ASTM D635.
- 7.7 All metal accessories shall be manufactured from (304 or 316) Stainless Steel, 2205 Duplex Stainless Steel, 2507 Super Duplex Stainless Steel, hot dipped galvanised steel or aluminium.
- 7.8 Load bars shall be joined with notched cross bars via interlocking methods and the use of chemical bonding.
- 7.9 The fibreglass reinforcement content shall be maintained at 65% (by weight) so as to achieve maximum loading capacity.
- 7.10 All fibreglass material shall have an ultraviolet light inhibiting chemical additive to resist UV degradation.
- 7.11 Grating shall be manufactured with a smooth, chequer plate, diamond plate or anti-slip Aluminium Oxide surface to provide optimum slip resistance.

8.0 Acceptable Manufacturer

The fibreglass underfoot moulded grating system shall be manufactured by Treadwell Group Pty Ltd of Australia.

Ordering Information

Code

- | | |
|--|--------------------------------|
| 1. Nominate the type of grating required | F-MG = GratEX® Moulded Grating |
| 2. Nominate the depth (mm) required | 30, 35, 50 and 60 |
| 3. Nominate the load bar centres required | (38/38) = 38mm x 38mm |
| 4. Nominate thickness solid top that you require | (3) = 3mm
(5) = 5mm |

Note: This section of the coding is typically separated from the next section of the coding by a dash (-)

- | | |
|--|--|
| 5. Specify the mesh type required | HDF = Heavy Duty Solid Surface (Flat) Mesh |
| 6. Specify the resin, material or type (see page 6) | O = O- Series
I = I- Series
V = V- Series |
| 7. Specify the colour required
<small>*In which instance a code and name of the selected colour must be mentioned within the description.</small> | G = Industrial Green
Y = Safety Yellow
LG = Light Grey
DG = Dark Grey
CH = Charcoal
C = Custom* |
| 8. Specify the surface style required | CG = Commercial Grade (Grit) Anti-Slip
G = Industrial Grade (Grit) Anti-Slip
MG = Marine Grade (Grit) Anti-Slip
CH = Chequer Plate
P = Plain(Flat) |

Note: The next section of coding is separated by a slash (/), it isn't required for custom jobs as GratEX® is available in a variety of size panels to suit applications.

- | | |
|-------------------------------------|---|
| 9. Nominate the panel size required | 1 = 1225 mm x 3665 mm
2 = 920 mm x 3055 mm |
|-------------------------------------|---|

Please refer to Appendix 3: GratEX® Ordering Codes - page 88

GratEX® Stair Treads

Can I Use FRP for Stair Treads?

Treadwell's range of GratEX® Stair Treads includes both open surface and closed surface options, and a range of surface patterns, colour and leading edge nosing options.

All GratEX® Premium and Standard Stair Tread options are moulded with the Solid Leading Edge Nosing as an integrated single stage operation. This increases the rigidity and durability of the entire leading edge, ensuring reliable performance in high traffic scenarios. All the treads with abrasive leading edge nosings are manufactured to conform to AS-1657-2013.

The GratEX® Stair Tread nosings are typically stocked in colours that contrast by 30% with the primary tread colour as per AS 1657-2013. This ensures maximum visual awareness of the stair treads forward edge for personnel utilising the stairways and consequently enhancing the OHS safety ratings.

Treadwell recommends that leading edge nosings are specified when ordering GratEX® Stair Treads as the safety risks associated with elevated work areas or walkways are significantly increased without them.

NOTE: A bearing surface of at least 40mm is recommended at either side of GratEX® Stair Treads. Compliance with AS 1657-2013 requires a Tread depth of > 225mm.

Selecting a tread with lasting non-slip properties, resilience to corrosion and proven long term cost advantages can help you enhance safety in the workplace by reducing the chance of slips, trips and falls.

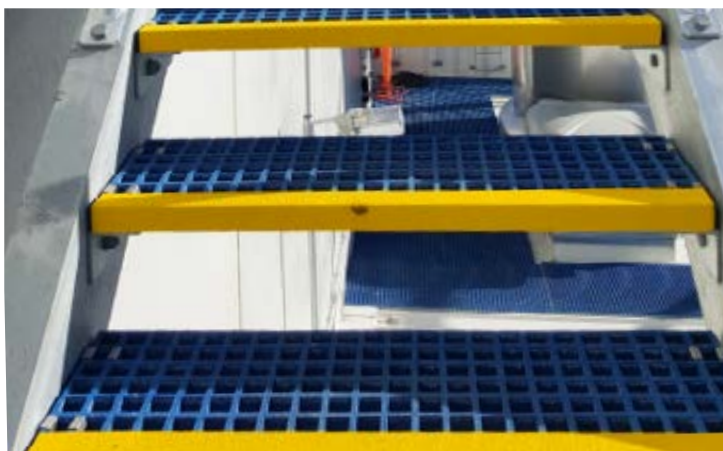

	Economy (STE)	Standard (STD)	Premium (STP)
GratEX® Square Mesh			
GratEX® Mini Mesh			
GratEX® Micro Mesh			

GratEX® Stair Treads

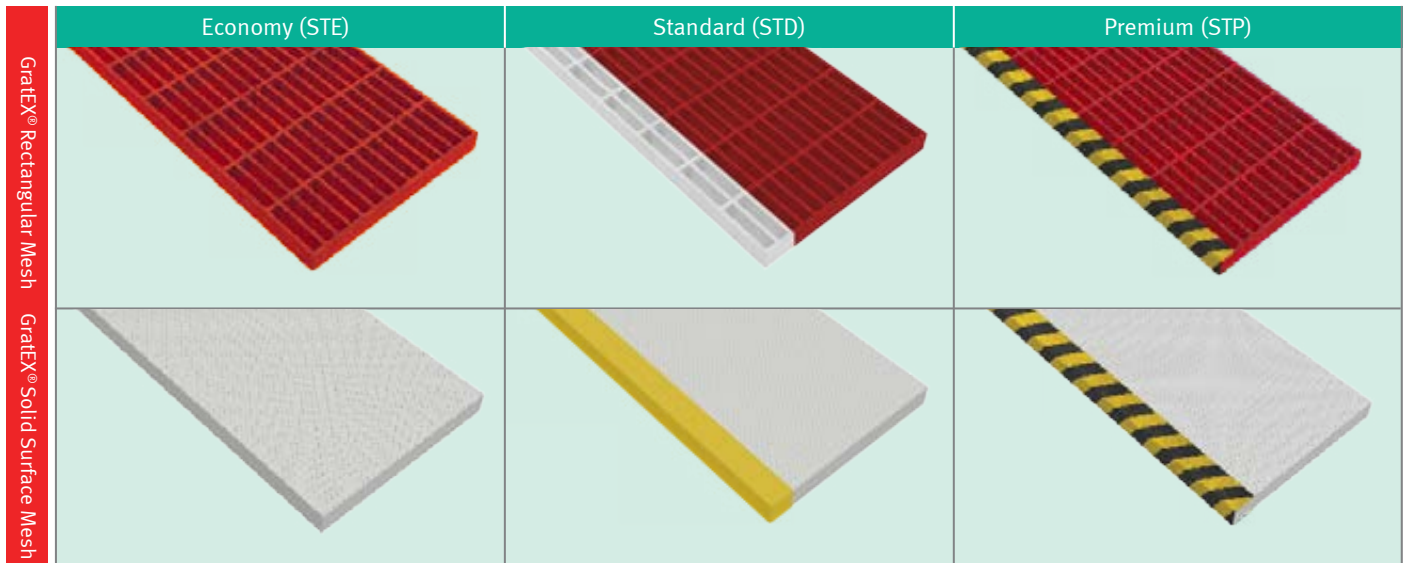

Ordering Information

	Code
1. Nominate the type of grating required	F-MG = GratEX® Moulded Grating
2. Choose the depth (mm) required	25, 30, 38, 50
3. Select the load bar centres required	(13/13) = 13mm x 13mm (25/25) = 25mm x 25mm (19/19) = 19mm x 19mm (38/38) = 38mm x 38mm (20/20) = 20mm x 20mm (50/50) = 50mm x 50mm
4. Select the mesh type required	S = Square mesh R = Rectangular M = Mini Mesh F = Solid Surface MM = Micro Mesh

Note: This section of the coding is typically separated from the next section of the coding by a dash (-)

5. Select the resin, material or type (see page 6)	O = O-Series I = I-Series V = V-Series
6. Choose the tread colour required (*In which instance a code and name of the selected colour must be mentioned within the description)	G = Industrial Green DG = Dark Grey Y = Safety Yellow CH = Charcoal LG = Light Grey C = Custom*
7. Select the surface style required	CG = Commercial Grade (Grit) Anti-Slip G = Industrial Grade (Grit) Anti-Slip MG = Marine Grade (Grit) Anti-Slip C = Concave P = Plain (Flat) CH = Checker Plate

Note: This section of the coding is typically separated from the next section of the coding by a dash (-)

8. Nominate the stair tread type	STE = Economy STC = Custom STP = Premium STK = Kit
9. Select the nosing colour required (*In which instance a code and name of the selected colour must be mentioned within the description)	(B) = Black (H) = Chevron (two tone) (Y) = Safety Yellow (C) = Custom*

Note: Please specify the tread size required and the side that you require the nosing on in the description.

Minimum width: 582mm
Maximum width: 3665mm

Minimum depth: 235mm
Maximum depth: 387mm

Example: F-MG38(38/38)S-IGG-STP(Y)

GratEX® Stair Tread Kits



Is there a GratEX® Stair Tread Retro-fit Option?

GratEX® Stair Tread Kits offer a complete 'change out' package to replace existing stair treads and stringer bracket assemblies that have suffered premature corrosion.

Traditionally, stringer bracket assemblies are made from metallic materials which require corrosion inhibiting coatings to ensure satisfactory life span. It is typical for stair tread mounting brackets to be drilled in situ after this coating has been applied, thus compromising the integrity of this first line of defence against corrosion. It is also common for stringer brackets to be constructed of lighter walled material than other adjacent componentry such as stringers.

These kits have been adopted as a superior replacement for the originally specified equipment in many instances as well as being chosen as a long life and cost saving alternative to metallic systems in numerous new plants.

Tread kits are available in all resin systems and are supplied with M-Clips as standard. Treads can be supplied assembled ready for installation or ready for assembly onsite. Likewise, stringer support brackets can be supplied with pre-drilled mounting holes if specified. Treadwell does not recommend the use of stair treads with a thickness of less than 25mm.

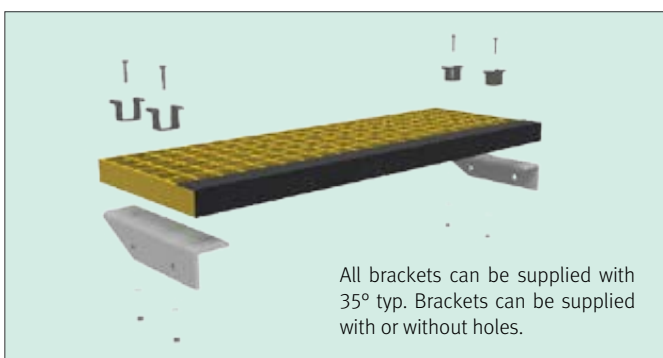

All brackets can be supplied with 35° typ. Brackets can be supplied with or without holes.

GratEX® Landings



GratEX® landings are also available as a part of Treadwell's extensive range.

GratEX® landings combine the lasting non-slip properties, the resilience to corrosion and the proven long term cost advantages of GratEX® stair treads with the durable nature of GratEX® grating.

These landings are custom made for each and every application, greatly enhance visibility and reduce the wear commonly seen on landings immensely.

Contact Treadwell's technical assistance team for further details.

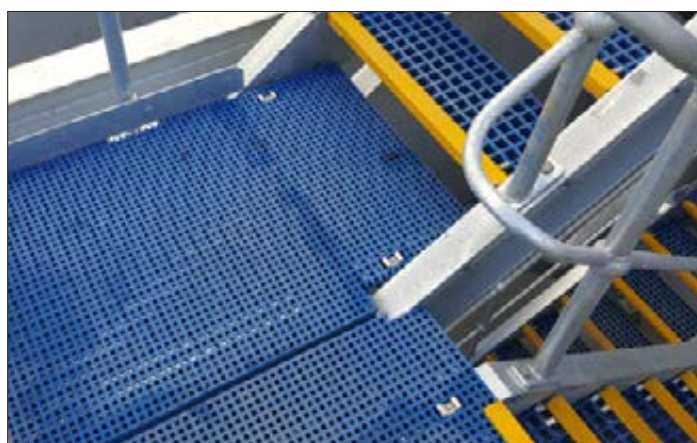

Fastening Clips & Installation Methods



Installation Accessories

The GratEX® Moulded FRP Grating products are complimented by an extensive range of fixing types and installation systems. All GratEX® installation clip sets are tested and proven to function in the harshest of applications, offering you total peace of mind.

All of the GratEX® installation systems are supplied and stocked as 316 grade stainless steel with super duplex, 304 grade stainless and galvanised steel options available upon request. This flexibility means that we can provide a suitable solution for whatever chemicals or application you have.

The GratEX® Clip range also includes a large range of underside clips which provides additional options when when designing sub-structures with the consideration of fixing methods. Refer to the StormChief® page for information on our unique range of extreme strength clip options for high wave action zones.

GratEX® Clip - Tops

STANDARD M	3D	PLAN	ELEVATION	FASTENING OPTIONS
Hole Diameter: 8mm Material type: 316 st/st Threaded hole: N/A				1, 3, 4, 6
MINI MESH M	3D	PLAN	ELEVATION	FASTENING OPTIONS
Hole Diameter: 6mm Material type: 316 st/st Threaded hole: N/A				5, 7
C	3D	PLAN	ELEVATION	FASTENING OPTIONS
Hole Diameter: 6mm Material type: 316 st/st Threaded hole: Yes				2
L	3D	PLAN	ELEVATION	FASTENING OPTIONS
Hole Diameter: 6.5mm Material type: 316 st/st Threaded hole: N/A				2
D	3D	PLAN	ELEVATION	FASTENING OPTIONS
Hole Diameter: 8.5mm Material type: 316 st/st Threaded hole: N/A				1, 3, 4, 6
E	3D	PLAN	ELEVATION	FASTENING OPTIONS
Hole Diameter: 8mm Material type: 316 st/st Threaded hole: N/A				1, 3, 4, 6
W	3D	PLAN	ELEVATION	FASTENING OPTIONS
Hole Diameter: 8mm Material type: 316 st/st Threaded hole: N/A				1, 3, 4, 6
S	3D	PLAN	ELEVATION	FASTENING OPTIONS
Hole Diameter: 5mm Material type: 316 st/st Threaded hole: N/A				5, 7
O	3D	PLAN	ELEVATION	FASTENING OPTIONS
Hole Diameter: 8mm Material type: 316 st/st Threaded hole: N/A				10

Fastening Clips & Installation Methods

Clamp Underside

J - UNIVERSAL	3D	PLAN	ELEVATION	SIDE ELEVATION	FASTENING OPTIONS
Hole Diameter: N/A Material type: 316 st/st Threaded hole: N/A					1, 3, 4
J - MINI-MESH	3D	PLAN	ELEVATION	SIDE ELEVATION	FASTENING OPTIONS
Hole Diameter: N/A Material type: 316 st/st Threaded hole: N/A					5
H	3D	PLAN	ELEVATION	FASTENING OPTIONS	
Hole Diameter: 8mm Material type: st/st Threaded hole: Yes				1, 3, 4	
G	3D	PLAN	ELEVATION	FASTENING OPTIONS	
Hole Diameter: 6mm Material type: st/st Threaded hole: Yes				2	
U	3D	PLAN	ELEVATION	FASTENING OPTIONS	
Hole Diameter: 8mm Material type: 316 st/st Threaded hole: Yes				1, 3, 4	
V	3D	PLAN	ELEVATION	FASTENING OPTIONS	
Hole Diameter: 8mm Material type: 316 st/st Threaded hole: N/A				1, 3, 4	
T	3D	PLAN	ELEVATION	FASTENING OPTIONS	
Hole Diameter: Material type: Threaded hole:				1, 3, 4, 9	

Fastening Options

1	2	3	4	5
F-FA(SC)-M8*40-HX-SS316 Metric 8mm x 40mm, 316 Grade Stainless Steel Set Screw with Hex Head c/w nylon nut and washer.	F-FA(SC)-M6*40-HX-SS316 Metric 6mm x 40mm, 316 Grade Stainless Steel Set Screw with Hex Head c/w nylon nut and washer.	F-FA(SC)-M8*40-SH-SS316 Metric 8mm x 40mm, 316 Grade Stainless Steel Set Screw with Socket Head c/w nylon nut and washer.	F-FA(SC)-M8*60-BH-SS316 Metric 8mm x 60mm, 316 Grade Stainless Steel Set Screw with Button Head c/w nylon nut and washer.	F-FA(B)-13/16*50-SH-SS304 Imperial 3/16" x 2", 304 Grade Steel Bolt with Socket Head c/w nylon nut.
6	7	8	9	10
F-FA(SD)-G14*50-HX-SS316 Type 17 (14 Gauge) Self Drilling Screw, 50mm, Hex Head, 316 Stainless Steel	F-FA(SD)-G12*50-TX-SS316 (12 Gauge) Self Drilling Screw, 50mm, Torx Head, 316 Stainless Steel	F-FA(ST)-G6.3*70-IHX-SS316 Type 17 (6.3 Gauge) Self Tapping Screw, 70mm, Internal Hex Drive, 316 Stainless Steel c/w washer.	F-FA(B)-M8*50-CH-SS316 8mm Thread Size, 50mm Length, Hexagon Height 5mm, 316 Stainless Steel.	F-FA(B)-M8*50-CS-SS316 8mm Thread Size, 50mm Length, 316 Stainless Steel.

Fastening Profiles Ordering Information:

Please refer to Appendix 6a: GratEX® Fasteners Ordering Information.

Fastening Clip Frequency Recommendation:

Treadwell recommends that at least 4 GratEX® clip sets be installed per panel, regardless of size, or approximately 4 per m² for areas exceeding 1 m². If you have a unique requirement, chances are we have encountered something similar before – contact Treadwell on 1800 246 800.

Fixing Assembly Combinations

M Clip Assembly

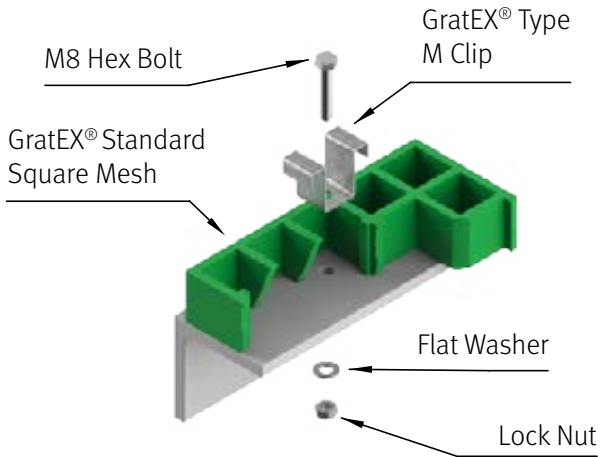

L Clip Assembly

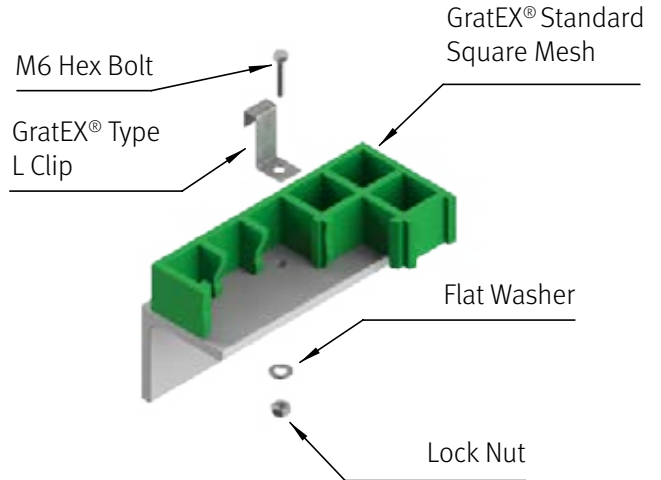

Mini M Clip Assembly

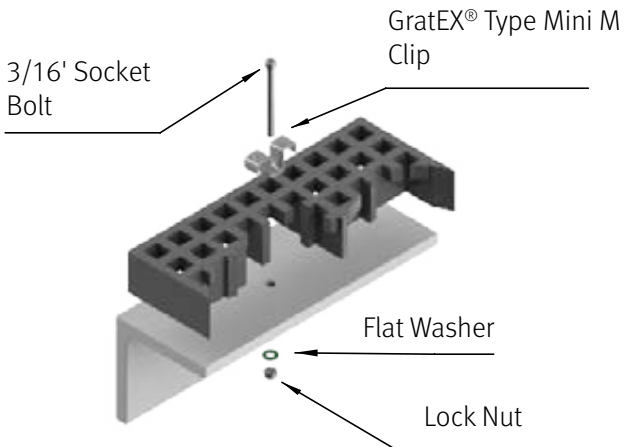

D Clip Assembly

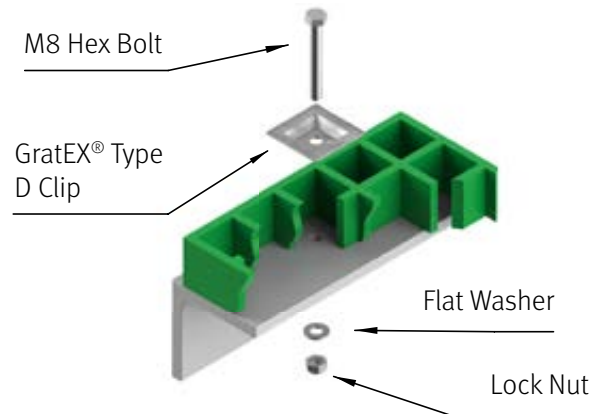

C Clip Assembly

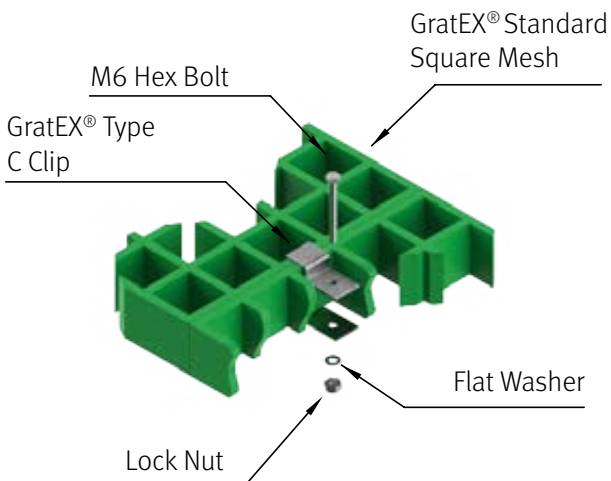

E Clip Assembly

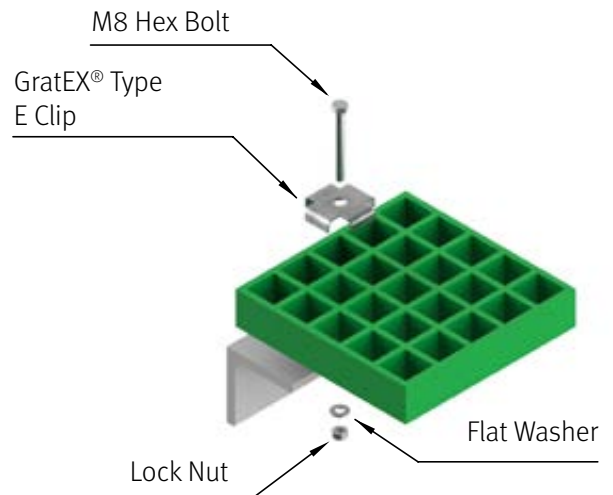

Fixing Assembly Combinations

S Clip Assembly

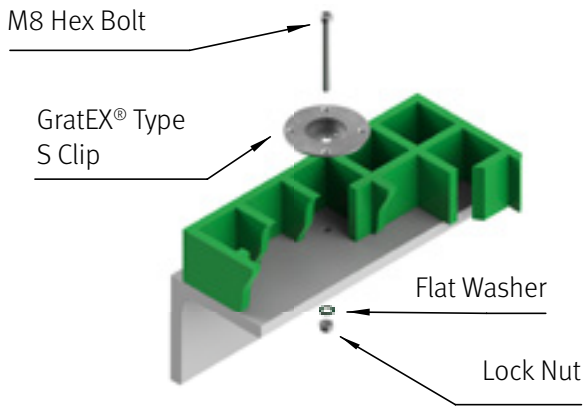

Micro Mesh Assembly

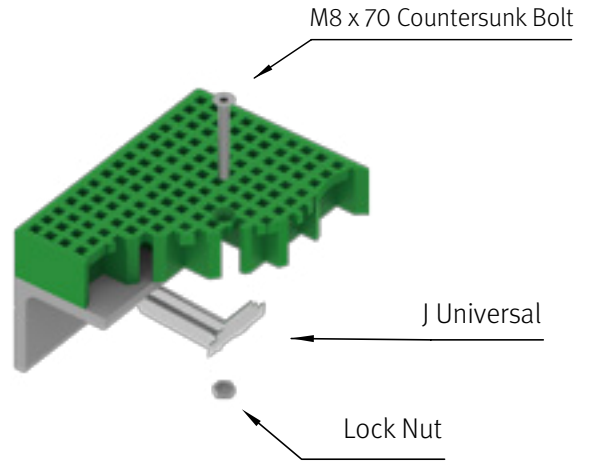

S Clip Installation Tool



Treadwell provides 38mm and 50mm S clips according to the needs of clients. To facilitate the sizes, our quality installation tools come in 32mm and 44mm to suit the size of each aperture.

Solid Surface Recess Tool



W Clip Assembly

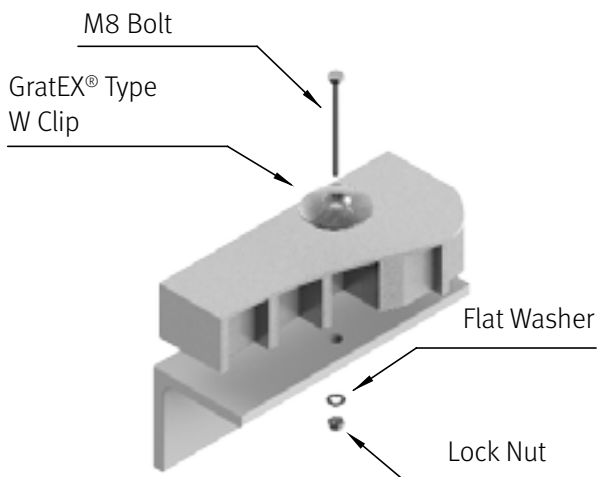

OH Clip Assembly

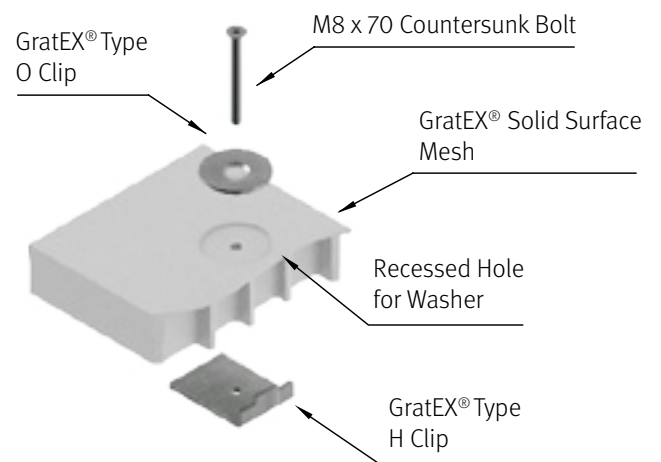

Fixing Assembly Combinations

MJ Clip Assembly

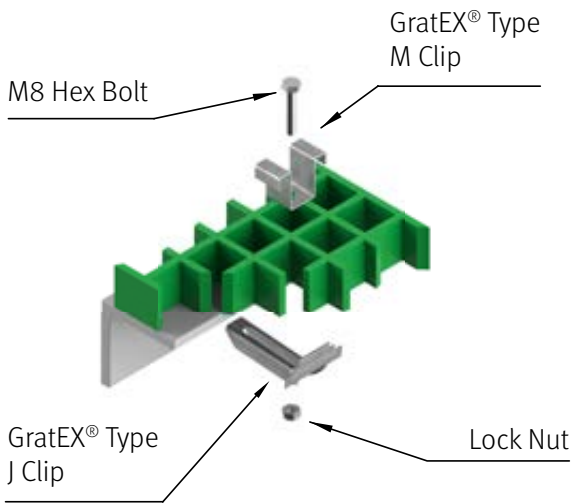

MH Clip Assembly

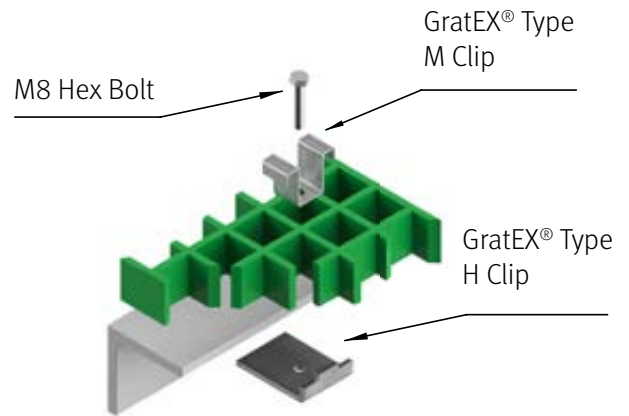

MU Clip Assembly

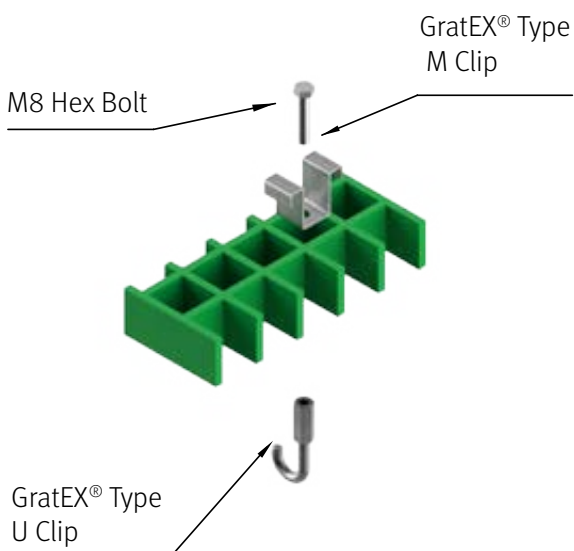

MV Clip Assembly

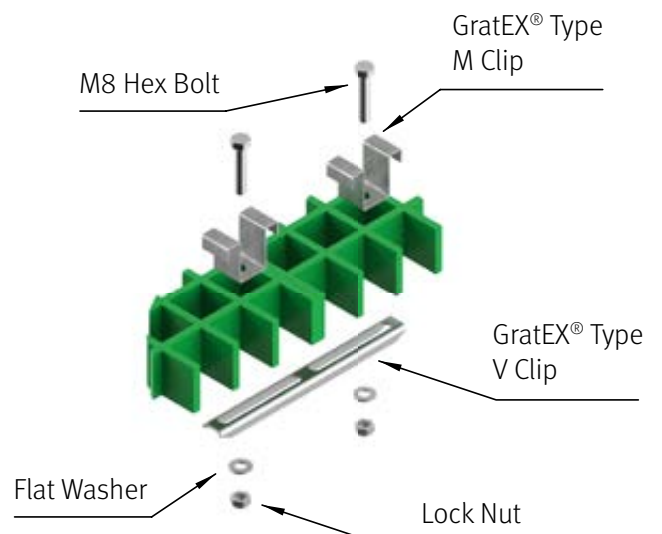

Fixing Assembly Combinations

DG Clip Assembly

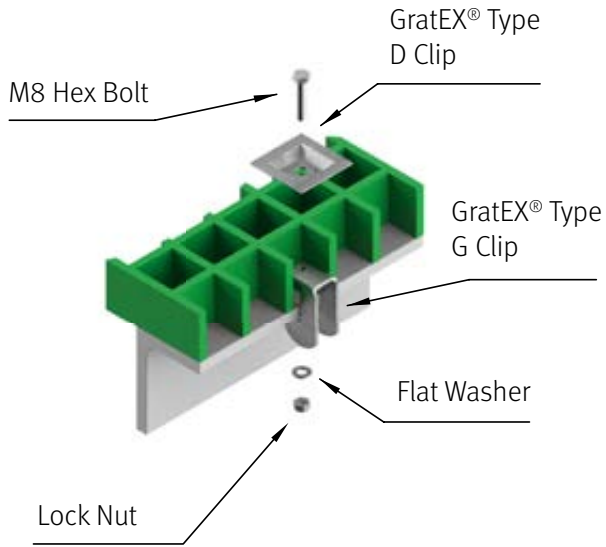

MJ Mini Mesh Assembly

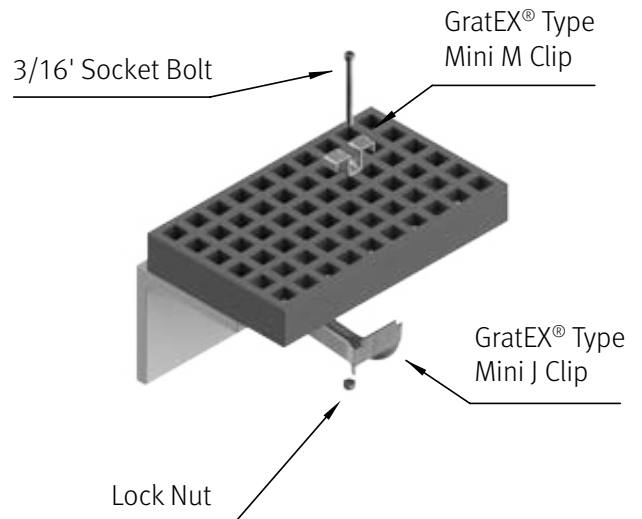

MT Clip Assembly

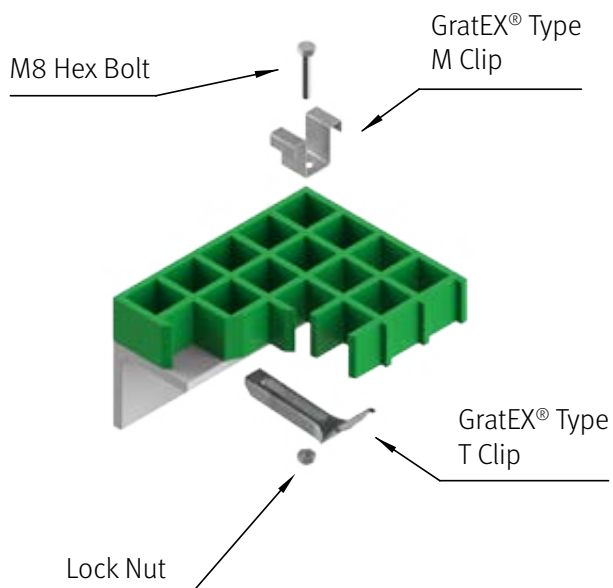

SJ Clip Assembly

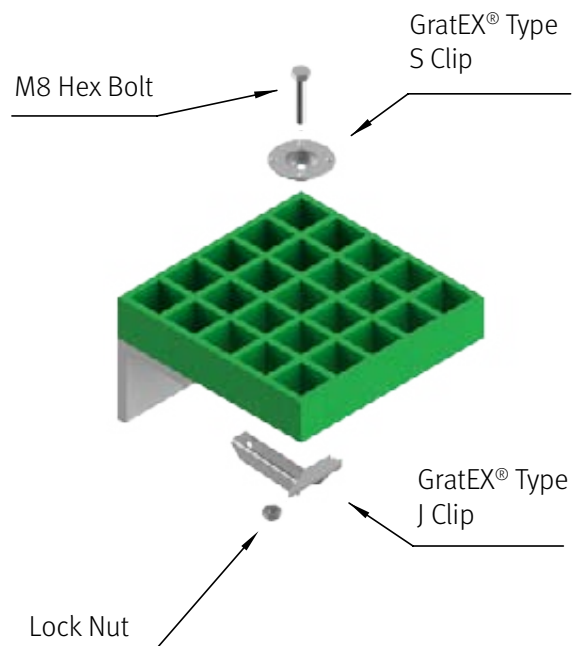

Closed Load Bar Charts

To find the closed load bar dimension that is closest to your required dimensions, simply find the table that relates to your preferred grating type and aperture, and then locate the dimension listed which varies the least from the required dimensions. These dimensions are indicative and can be varied slightly in manufacture. The Treadwell team can provide advice on designing around grating closed load bar dimensions – please call 1800 246 800.

GratEX® Square Mesh

38 x 38 Mesh Grid Load Bar Chart

No. of Bars	mm								
2	44.5	22	806.5	42	1568.5	62	2330.5	82	3092.5
3	82.6	23	844.6	43	1606.6	63	2368.6	83	3130.6
4	120.7	24	882.7	44	1644.7	64	2406.7	84	3168.7
5	158.8	25	920.8	45	1682.8	65	2444.8	85	3206.8
6	196.9	26	958.9	46	1720.9	66	2482.9	86	3244.9
7	235	27	997.0	47	1759.0	67	2521.0	87	3283.0
8	273.1	28	1035.1	48	1797.1	68	2559.1	88	3321.1
9	311.2	29	1073.2	49	1835.2	69	2597.2	89	3359.2
10	349.3	30	1111.3	50	1873.3	70	2635.3	90	3397.3
11	387.4	31	1149.4	51	1911.4	71	2673.4	91	3435.4
12	425.5	32	1187.5	52	1949.5	72	2711.5	92	3473.5
13	463.6	33	1225.6	53	1987.6	73	2749.6	93	3511.6
14	501.7	34	1263.7	54	2025.7	74	2787.7	94	3549.7
15	539.8	35	1301.8	55	2063.8	75	2825.8	95	3587.8
16	577.9	36	1339.9	56	2101.9	76	2863.9	96	3625.9
17	616	37	1378.0	57	2140.0	77	2902.0	97	3664.0
18	654.1	38	1416.1	58	2178.1	78	2940.1	98	3702.1
19	692.2	39	1454.2	59	2216.2	79	2978.2	99	3740.2
20	730.3	40	1492.3	60	2254.3	80	3016.3	100	3778.3
21	768.4	41	1530.4	61	2292.4	81	3054.4	101	3816.4

40 x 40 Mesh Grid Load Bar Chart

No. of Bars	mm								
2	46.4	22	846.4	42	1646.4	62	2446.4	82	3246.4
3	86.4	23	886.4	43	1686.4	63	2486.4	83	3286.4
4	126.4	24	926.4	44	1726.4	64	2526.4	84	3326.4
5	166.4	25	966.4	45	1766.4	65	2566.4	85	3366.4
6	206.4	26	1006.4	46	1806.4	66	2606.4	86	3406.4
7	246.4	27	1046.4	47	1846.4	67	2646.4	87	3446.4
8	286.4	28	1086.4	48	1886.4	68	2686.4	88	3486.4
9	326.4	29	1126.4	49	1926.4	69	2726.4	89	3526.4
10	366.4	30	1166.4	50	1966.4	70	2766.4	90	3566.4
11	406.4	31	1206.4	51	2006.4	71	2806.4	91	3606.4
12	446.4	32	1246.4	52	2046.4	72	2846.4	92	3646.4
13	486.4	33	1286.4	53	2086.4	73	2886.4	93	3686.4
14	526.4	34	1326.4	54	2126.4	74	2926.4	94	3726.4
15	566.4	35	1366.4	55	2166.4	75	2966.4	95	3766.4
16	606.4	36	1406.4	56	2206.4	76	3006.4	96	3806.4
17	646.4	37	1446.4	57	2246.4	77	3046.4	97	3846.4
18	686.4	38	1486.4	58	2286.4	78	3086.4	98	3886.4
19	726.4	39	1526.4	59	2326.4	79	3126.4	99	3926.4
20	766.4	40	1566.4	60	2366.4	80	3166.4	100	3966.4
21	806.4	41	1606.4	61	2406.4	81	3206.4	101	4006.4

50.8 x 50.8 Mesh Grid Load Bar Chart

No. of Bars	mm								
2	57.2	22	1073.2	42	2089.2	62	3105.2	82	4121.2
3	108.0	23	1124.0	43	2140.0	63	3156.0	83	4172.0
4	158.8	24	1174.8	44	2190.8	64	3206.8	84	4222.8
5	209.6	25	1225.6	45	2241.6	65	3257.6	85	4273.6
6	260.4	26	1276.4	46	2292.4	66	3308.4	86	4324.4
7	311.2	27	1327.2	47	2343.2	67	3359.2	87	4375.2
8	362.0	28	1378.0	48	2394.0	68	3410.0	88	4426.0
9	412.8	29	1428.8	49	2444.8	69	3460.8	89	4476.8
10	463.6	30	1479.6	50	2495.6	70	3511.6	90	4527.6
11	514.4	31	1530.4	51	2546.4	71	3562.4	91	4578.4
12	565.2	32	1581.2	52	2597.2	72	3613.2	92	4629.2
13	616.0	33	1632.0	53	2648.0	73	3664.0	93	4680.0
14	666.8	34	1682.8	54	2698.8	74	3714.8	94	4730.8
15	717.6	35	1733.6	55	2749.6	75	3765.6	95	4781.6
16	768.4	36	1784.4	56	2800.4	76	3816.4	96	4832.4
17	819.2	37	1835.2	57	2851.2	77	3867.2	97	4883.2
18	870.0	38	1886.0	58	2902.0	78	3918.0	98	4934.0
19	920.8	39	1936.8	59	2952.8	79	3968.8	99	4984.8
20	971.6	40	1987.6	60	3003.6	80	4019.6	100	5035.6
21	1022.4	41	2038.4	61	3054.4	81	4070.4	101	5086.4

79 x 79 Mesh Grid Load Bar Chart

No. of Bars	mm								
2	85.4	22	1665.4	42	3245.4	62	4825.4	82	6405.4
3	164.4	23	1744.4	43	3324.4	63	4904.4	83	6484.4
4	243.4	24	1823.4	44	3403.4	64	4983.4	84	6563.4
5	322.4	25	1902.4	45	3482.4	65	5062.4	85	6642.4
6	401.4	26	1981.4	46	3561.4	66	5141.4	86	6721.4
7	480.4	27	2060.4	47	3640.4	67	5220.4	87	6800.4
8	559.4	28	2139.4	48	3719.4	68	5299.4	88	6879.4
9	638.4	29	2218.4	49	3798.4	69	5378.4	89	6958.4
10	717.4	30	2297.4	50	3877.4	70	5457.4	90	7037.4
11	796.4	31	2376.4	51	3956.4	71	5536.4	91	7116.4
12	875.4	32	2455.4	52	4035.4	72	5615.4	92	7195.4
13	954.4	33	2534.4	53	4114.4	73	5694.4	93	7274.4
14	1033.4	34	2613.4	54	4193.4	74	5773.4	94	7353.4
15	1112.4	35	2692.4	55	4272.4	75	5852.4	95	7432.4
16	1191.4	36	2771.4	56	4351.4	76	5931.4	96	7511.4
17	1270.4	37	2850.4	57	4430.4	77	6010.4	97	7590.4
18	1349.4	38	2929.4	58	4509.4	78	6089.4	98	7669.4
19	1428.4	39	3008.4	59	4588.4	79	6168.4	99	7748.4
20	1507.4	40	3087.4	60	4667.4	80	6247.4	100	7827.4
21	1586.4	41	3166.4	61	4746.4	81	6326.4	101	7906.4

Clause: The figures are indicative or an estimate only. This is a guide and an allowance for manufacturing tolerances (page 76) should be made.

Closed Load Bar Charts

GratEX® Heavy Duty Mesh

80 x 80 Mesh Grid Load Bar Chart

No. of Bars	mm								
2	86.4	12	886.4	22	1686.4	32	2486.4	42	3286.4
3	166.4	13	966.4	23	1766.4	33	2566.4	43	3366.4
4	246.4	14	1046.4	24	1846.4	34	2646.4	44	3446.4
5	326.4	15	1126.4	25	1926.4	35	2726.4	45	3526.4
6	406.4	16	1206.4	26	2006.4	36	2806.4	46	3606.4
7	486.4	17	1286.4	27	2086.4	37	2886.4	47	3686.4
8	566.4	18	1366.4	28	2166.4	38	2966.4	48	3766.4
9	646.4	19	1446.4	29	2246.4	39	3046.4	49	3846.4
10	726.4	20	1526.4	30	2326.4	40	3126.4	50	3926.4
11	806.4	21	1606.4	31	2406.4	41	3206.4	51	4006.4

38.1 x 38.1 Heavy Duty Mesh Grid Load Bar Chart

No. of Bars	mm									
2	48.6	22	810.6	42	1572.6	62	2334.6	82	3096.6	
3	86.7	23	848.7	43	1610.7	63	2372.7	83	3134.7	
4	124.8	24	886.8	44	1648.8	64	2410.8	84	3172.8	
5	162.9	25	924.9	45	1686.9	65	2448.9	85	3210.9	
6	201.0	26	963.0	46	1725.0	66	2487.0	86	3249.0	
7	239.1	27	1001.1	47	1763.1	67	2525.1	87	3287.1	
8	277.2	28	1039.2	48	1801.2	68	2563.2	88	3325.2	
9	315.3	29	1077.3	49	1839.3	69	2601.3	89	3363.3	
10	353.4	30	1115.4	50	1877.4	70	2639.4	90	3401.4	
11	391.5	31	1153.5	51	1915.5	71	2677.5	91	3439.5	
12	429.6	32	1191.6	52	1953.6	72	2715.6	92	3477.6	
13	467.7	33	1229.7	53	1991.7	73	2753.7	93	3515.7	
14	505.8	34	1267.8	54	2029.8	74	2791.8	94	3553.8	
15	543.9	35	1305.9	55	2067.9	75	2829.9	95	3591.9	
16	582.0	36	1344.0	56	2106.0	76	2868.0	96	3630.0	
17	620.1	37	1382.1	57	2144.1	77	2906.1	97	3668.1	
18	658.2	38	1420.2	58	2182.2	78	2944.2	98	3706.2	
19	696.3	39	1458.3	59	2220.3	79	2982.3	99	3744.3	
20	734.4	40	1496.4	60	2258.4	80	3020.4	100	3782.4	
21	772.5	41	1534.5	61	2296.5	81	3058.5	101	3820.5	

GratEX® Mini-Mesh

19.05 x 19.05 Mini Mesh Grid Load Bar Chart

No. of Bars	mm																		
2	26.1	12	216.6	22	407.1	32	597.6	42	788.0	52	978.5	62	1169.1	72	1359.6	82	1550.1	92	1740.6
3	45.1	13	235.6	23	426.1	33	616.6	43	807.1	53	997.6	63	1188.1	73	1378.6	83	1569.1	93	1759.6
4	64.2	14	254.7	24	445.2	34	635.7	44	826.1	54	1016.7	64	1207.2	74	1397.7	84	1588.2	94	1778.7
5	83.2	15	273.7	25	464.2	35	654.7	45	845.2	55	1035.7	65	1226.2	75	1416.7	85	1607.2	95	1797.7
6	102.3	16	292.8	26	483.3	36	673.8	46	864.2	56	1054.8	66	1245.3	76	1435.8	86	1626.3	96	1816.8
7	121.3	17	311.8	27	502.3	37	692.8	47	883.3	57	1073.8	67	1264.3	77	1454.8	87	1645.3	97	1835.8
8	140.4	18	330.9	28	521.4	38	711.9	48	902.3	58	1092.9	68	1283.4	78	1473.9	88	1664.4	98	1854.9
9	159.4	19	349.9	29	540.4	39	730.9	49	921.4	59	1111.9	69	1302.4	79	1492.9	89	1683.4	99	1873.9
10	178.5	20	369.0	30	559.5	40	750.0	50	940.4	60	1131.0	70	1321.5	80	1512.0	90	1702.5	100	1893.0
11	197.5	21	388.0	31	578.5	41	769.0	51	959.5	61	1150.0	71	1340.5	81	1531.0	91	1721.5	101	1912.0

Clause: The figures are indicative or an estimate only. This is a guide and an allowance for manufacturing tolerances (page 76) should be made.

Closed Load Bar Charts

GratEX® Mini-Mesh

20 x 20 Mini Mesh Grid Load Bar Chart

No. of Bars	mm																				
2	27.0	20	387.0	38	747.0	56	1107.0	74	1467.0	92	1827.0	110	2187.0	128	2547.0	146	2907.0	164	3267.0	182	3627.0
3	47.0	21	407.0	39	767.0	57	1127.0	75	1487.0	93	1847.0	111	2207.0	129	2567.0	147	2927.0	165	3287.0	183	3647.0
4	67.0	22	427.0	40	787.0	58	1147.0	76	1507.0	94	1867.0	112	2227.0	130	2587.0	148	2947.0	166	3307.0	184	3667.0
5	87.0	23	447.0	41	807.0	59	1167.0	77	1527.0	95	1887.0	113	2247.0	131	2607.0	149	2967.0	167	3327.0	185	3687.0
6	107.0	24	467.0	42	827.0	60	1187.0	78	1547.0	96	1907.0	114	2267.0	132	2627.0	150	2987.0	168	3347.0	186	3707.0
7	127.0	25	487.0	43	847.0	61	1207.0	79	1567.0	97	1927.0	115	2287.0	133	2647.0	151	3007.0	169	3367.0	187	3727.0
8	147.0	26	507.0	44	867.0	62	1227.0	80	1587.0	98	1947.0	116	2307.0	134	2667.0	152	3027.0	170	3387.0	188	3747.0
9	167.0	27	527.0	45	887.0	63	1247.0	81	1607.0	99	1967.0	117	2327.0	135	2687.0	153	3047.0	171	3407.0	189	3767.0
10	187.0	28	547.0	46	907.0	64	1267.0	82	1627.0	100	1987.0	118	2347.0	136	2707.0	154	3067.0	172	3427.0	190	3787.0
11	207.0	29	567.0	47	927.0	65	1287.0	83	1647.0	101	2007.0	119	2367.0	137	2727.0	155	3087.0	173	3447.0	191	3807.0
12	227.0	30	587.0	48	947.0	66	1307.0	84	1667.0	102	2027.0	120	2387.0	138	2747.0	156	3107.0	174	3467.0	192	3827.0
13	247.0	31	607.0	49	967.0	67	1327.0	85	1687.0	103	2047.0	121	2407.0	139	2767.0	157	3127.0	175	3487.0	193	3847.0
14	267.0	32	627.0	50	987.0	68	1347.0	86	1707.0	104	2067.0	122	2427.0	140	2787.0	158	3147.0	176	3507.0	194	3867.0
15	287.0	33	647.0	51	1007.0	69	1367.0	87	1727.0	105	2087.0	123	2447.0	141	2807.0	159	3167.0	177	3527.0	195	3887.0
16	307.0	34	667.0	52	1027.0	70	1387.0	88	1747.0	106	2107.0	124	2467.0	142	2827.0	160	3187.0	178	3547.0	196	3907.0
17	327.0	35	687.0	53	1047.0	71	1407.0	89	1767.0	107	2127.0	125	2487.0	143	2847.0	161	3207.0	179	3567.0	197	3927.0
18	347.0	36	707.0	54	1067.0	72	1427.0	90	1787.0	108	2147.0	126	2507.0	144	2867.0	162	3227.0	180	3587.0	198	3947.0
19	367.0	37	727.0	55	1087.0	73	1447.0	91	1807.0	109	2167.0	127	2527.0	145	2887.0	163	3247.0	181	3607.0	199	3967.0

25.4 x 25.4 Mini Mesh Grid Load Bar Chart

No. of Bars	mm																				
2	33.4	16	389.0	30	744.6	44	1100.2	58	1455.8	72	1811.4	86	2167.0	100	2522.6	114	2878.2	128	3233.8	142	3589.4
3	58.8	17	414.4	31	770.0	45	1125.6	59	1481.2	73	1836.8	87	2192.4	101	2548.0	115	2903.6	129	3259.2	143	3614.8
4	84.2	18	439.8	32	795.4	46	1151.0	60	1506.6	74	1862.2	88	2217.8	102	2573.4	116	2929.0	130	3284.6	144	3640.2
5	109.6	19	465.2	33	820.8	47	1176.4	61	1532.0	75	1887.6	89	2243.2	103	2598.8	117	2954.4	131	3310.0	145	3665.6
6	135.0	20	490.6	34	846.2	48	1201.8	62	1557.4	76	1913.0	90	2268.6	104	2624.2	118	2979.8	132	3335.4	146	3691.0
7	160.4	21	516.0	35	871.6	49	1227.2	63	1582.8	77	1938.4	91	2294.0	105	2649.6	119	3005.2	133	3360.8	147	3716.4
8	185.8	22	541.4	36	897.0	50	1252.6	64	1608.2	78	1963.8	92	2319.4	106	2675.0	120	3030.6	134	3386.2	148	3741.8
9	211.2	23	566.8	37	922.4	51	1278.0	65	1633.6	79	1989.2	93	2344.8	107	2700.4	121	3056.0	135	3411.6	149	3767.2
10	236.6	24	592.2	38	947.8	52	1303.4	66	1659.0	80	2014.6	94	2370.2	108	2725.8	122	3081.4	136	3437.0	150	3792.6
11	262.0	25	617.6	39	973.2	53	1328.8	67	1684.4	81	2040.0	95	2395.6	109	2751.2	123	3106.8	137	3462.4	151	3818.0
12	287.4	26	643.0	40	998.6	54	1354.2	68	1709.8	82	2065.4	96	2421.0	110	2776.6	124	3132.2	138	3487.8	152	3843.4
13	312.8	27	668.4	41	1024.0	55	1379.6	69	1735.2	83	2090.8	97	2446.4	111	2802.0	125	3157.6	139	3513.2	153	3868.8
14	338.2	28	693.8	42	1049.4	56	1405.0	70	1760.6	84	2116.2	98	2471.8	112	2827.4	126	3183.0	140	3538.6	154	3894.2
15	363.6	29	719.2	43	1074.8	57	1430.4	71	1786.0	85	2141.6	99	2497.2	113	2852.8	127	3208.4	141	3564.0	155	3919.6

Clause: The figures are indicative or an estimate only. This is a guide and an allowance for manufacturing tolerances (page 76) should be made.

Closed Load Bar Charts

GratEX® Micro Mesh Micro Mesh Grid Load Bar Chart

No. of Bars	mm																		
2	18.8	34	425.0	66	828.8	98	1234.8	130	1641.0	162	2044.8	194	2450.8	226	2857.0	258	3260.8	290	3666.8
3	30.8	35	436.8	67	843.0	99	1246.8	131	1652.8	163	2059.0	195	2462.8	227	2868.8	259	3275.0	291	3678.8
4	45.0	36	448.8	68	854.8	100	1261.0	132	1664.8	164	2070.8	196	2477.0	228	2880.8	260	3286.8	292	3693.0
5	56.8	37	463.0	69	866.8	101	1272.8	133	1679.0	165	2082.8	197	2488.8	229	2895.0	261	3298.8	293	3704.8
6	68.8	38	474.8	70	881.0	102	1284.8	134	1690.8	166	2097.0	198	2500.8	230	2906.8	262	3313.0	294	3716.8
7	83.0	39	486.8	71	892.8	103	1299.0	135	1702.8	167	2108.8	199	2515.0	231	2918.8	263	3324.8	295	3731.0
8	94.8	40	501.0	72	904.8	104	1310.8	136	1717.0	168	2120.8	200	2526.8	232	2933.0	264	3336.8	296	3742.8
9	106.8	41	512.8	73	919.0	105	1322.8	137	1728.8	169	2135.0	201	2538.8	233	2944.8	265	3351.0	297	3754.8
10	121.0	42	524.8	74	930.8	106	1337.0	138	1740.8	170	2146.8	202	2553.0	234	2956.8	266	3362.8	298	3769.0
11	132.8	43	539.0	75	942.8	107	1348.8	139	1755.0	171	2158.8	203	2564.8	235	2971.0	267	3374.8	299	3780.8
12	144.8	44	550.8	76	957.0	108	1360.8	140	1766.8	172	2173.0	204	2576.8	236	2982.8	268	3389.0	300	3792.8
13	159.0	45	562.8	77	968.8	109	1375.0	141	1778.8	173	2184.8	205	2591.0	237	2994.8	269	3400.8	301	3807.0
14	170.8	46	577.0	78	980.8	110	1386.8	142	1793.0	174	2196.8	206	2602.8	238	3009.0	270	3412.8	302	3818.8
15	182.8	47	588.8	79	995.0	111	1398.8	143	1804.8	175	2211.0	207	2614.8	239	3020.8	271	3427.0	303	3830.8
16	197.0	48	600.8	80	1006.8	112	1413.0	144	1816.8	176	2222.8	208	2629.0	240	3032.8	272	3438.8	304	3845.0
17	208.8	49	615.0	81	1018.8	113	1424.8	145	1831.0	177	2234.8	209	2640.8	241	3047.0	273	3450.8	305	3856.8
18	220.8	50	626.8	82	1033.0	114	1436.8	146	1842.8	178	2249.0	210	2652.8	242	3058.8	274	3465.0	306	3868.8
19	235.0	51	638.8	83	1044.8	115	1451.0	147	1854.8	179	2260.8	211	2667.0	243	3070.8	275	3476.8	307	3883.0
20	246.8	52	653.0	84	1056.8	116	1462.8	148	1869.0	180	2272.8	212	2678.8	244	3085.0	276	3488.8	308	3894.8
21	258.8	53	664.8	85	1071.0	117	1474.8	149	1880.8	181	2287.0	213	2690.8	245	3096.8	277	3503.0	309	3906.8
22	273.0	54	676.8	86	1082.8	118	1489.0	150	1892.8	182	2298.8	214	2705.0	246	3108.8	278	3514.8	310	3921.0
23	284.8	55	691.0	87	1094.8	119	1500.8	151	1907.0	183	2310.8	215	2716.8	247	3123.0	279	3526.8	311	3932.8
24	296.8	56	702.8	88	1109.0	120	1512.8	152	1918.8	184	2325.0	216	2728.8	248	3134.8	280	3541.0	312	3944.8
25	311.0	57	714.8	89	1120.8	121	1527.0	153	1930.8	185	2336.8	217	2743.0	249	3146.8	281	3552.8	313	3959.0
26	322.8	58	729.0	90	1132.8	122	1538.8	154	1945.0	186	2348.8	218	2754.8	250	3161.0	282	3564.8	314	3970.8
27	334.8	59	740.8	91	1147.0	123	1550.8	155	1956.8	187	2363.0	219	2766.8	251	3172.8	283	3579.0	315	3982.8
28	349.0	60	752.8	92	1158.8	124	1565.0	156	1968.8	188	2374.8	220	2781.0	252	3184.8	284	3590.8	316	3997.0
29	360.8	61	767.0	93	1170.8	125	1576.8	157	1983.0	189	2386.8	221	2792.8	253	3199.0	285	3602.8	317	4008.8
30	372.8	62	778.8	94	1185.0	126	1588.8	158	1994.8	190	2401.0	222	2804.8	254	3210.8	286	3617.0	318	4020.8
31	387.0	63	790.8	95	1196.8	127	1603.0	159	2006.8	191	2412.8	223	2819.0	255	3222.8	287	3628.8	319	4035.0
32	398.8	64	805.0	96	1208.8	128	1614.8	160	2021.0	192	2424.8	224	2830.8	256	3237.0	288	3640.8	320	4046.8
33	410.8	65	816.8	97	1223.0	129	1626.8	161	2032.8	193	2439.0	225	2842.8	257	3248.8	289	3655.0		

GratEX® Rectangular Mesh 25 x 100 Mesh Grid Load Bar Chart

No. of Bars	mm	(Length)						No. of Bars	mm	(Width)									
		2	3	4	5	6	7			2	3	4	5	6	7				
2	106.4	10	906.4	18	1706.4	26	2506.4	34	3306.4	2	31.4	10	231.4	18	431.4	26	631.4	34	831.4
3	206.4	11	1006.4	19	1806.4	27	2606.4	35	3406.4	3	56.4	11	256.4	19	456.4	27	656.4	35	856.4
4	306.4	12	1106.4	20	1906.4	28	2706.4	36	3506.4	4	81.4	12	281.4	20	481.4	28	681.4	36	881.4
5	406.4	13	1206.4	21	2006.4	29	2806.4	37	3606.4	5	106.4	13	306.4	21	506.4	29	706.4	37	906.4
6	506.4	14	1306.4	22	2106.4	30	2906.4	38	3706.4	6	131.4	14	331.4	22	531.4	30	731.4	38	931.4
7	606.4	15	1406.4	23	2206.4	31	3006.4	39	3806.4	7	156.4	15	356.4	23	556.4	31	756.4	39	956.4
8	706.4	16	1506.4	24	2306.4	32	3106.4	40	3906.4	8	181.4	16	381.4	24	581.4	32	781.4	40	981.4
9	806.4	17	1606.4	25	2406.4	33	3206.4	41	4006.4	9	206.4	17	406.4	25	606.4	33	806.4	41	1006.4

Clause: The figures are indicative or an estimate only. This is a guide and an allowance for manufacturing tolerances (page 76) should be made.

Closed Load Bar Charts

GratEX® Rectangular Mesh

25 x 152 Mesh Grid Load Bar Chart

No. of Bars	mm	(Length)								No. of Bars	mm	(Width)							
		2	3	4	5	6	7	8	9			2	3	4	5	6	7	8	9
2	158.4	10	1374.4	18	2590.4	26	3806.4	34	5022.4	2	31.4	10	231.4	18	431.4	26	631.4	34	831.4
3	310.4	11	1526.4	19	2742.4	27	3958.4	35	5174.4	3	56.4	11	256.4	19	456.4	27	656.4	35	856.4
4	462.4	12	1678.4	20	2894.4	28	4110.4	36	5326.4	4	81.4	12	281.4	20	481.4	28	681.4	36	881.4
5	614.4	13	1830.4	21	3046.4	29	4262.4	37	5478.4	5	106.4	13	306.4	21	506.4	29	706.4	37	906.4
6	766.4	14	1982.4	22	3198.4	30	4414.4	38	5630.4	6	131.4	14	331.4	22	531.4	30	731.4	38	931.4
7	918.4	15	2134.4	23	3350.4	31	4566.4	39	5782.4	7	156.4	15	356.4	23	556.4	31	756.4	39	956.4
8	1070.4	16	2286.4	24	3502.4	32	4718.4	40	5934.4	8	181.4	16	381.4	24	581.4	32	781.4	40	981.4
9	1222.4	17	2438.4	25	3654.4	33	4870.4	41	6086.4	9	206.4	17	406.4	25	606.4	33	806.4	41	1006.4

38 x 100 Mesh Grid Load Bar Chart

No. of Bars	mm	(Length)								No. of Bars	mm	(Width)							
		2	3	4	5	6	7	8	9			2	3	4	5	6	7	8	9
2	106.4	7	606.4	12	1106.4	17	1606.4	22	2106.4	2	44.4	7	234.4	12	424.4	17	614.4	22	804.4
3	206.4	8	706.4	13	1206.4	18	1706.4	23	2206.4	3	82.4	8	272.4	13	462.4	18	652.4	23	842.4
4	306.4	9	806.4	14	1306.4	19	1806.4	24	2306.4	4	120.4	9	310.4	14	500.4	19	690.4	24	880.4
5	406.4	10	906.4	15	1406.4	20	1906.4	25	2406.4	5	158.4	10	348.4	15	538.4	20	728.4	25	918.4
6	506.4	11	1006.4	16	1506.4	21	2006.4	26	2506.4	6	196.4	11	386.4	16	576.4	21	766.4	26	956.4

60 x 220 Mesh Grid Load Bar Chart

No. of Bars	mm	(Length)								No. of Bars	mm	(Width)							
		2	3	4	5	6	7	8	9			2	3	4	5	6	7	8	9
2	226.4	8	1546.4	14	2866.4	20	4186.4	26	5506.4	2	66.4	8	426.4	14	786.4	20	1146.4	26	1506.4
3	446.4	9	1766.4	15	3086.4	21	4406.4	27	5726.4	3	126.4	9	486.4	15	846.4	21	1206.4	27	1566.4
4	666.4	10	1986.4	16	3306.4	22	4626.4	28	5946.4	4	186.4	10	546.4	16	906.4	22	1266.4	28	1626.4
5	886.4	11	2206.4	17	3526.4	23	4846.4	29	6166.4	5	246.4	11	606.4	17	966.4	23	1326.4	29	1686.4
6	1106.4	12	2426.4	18	3746.4	24	5066.4	30	6386.4	6	306.4	12	666.4	18	1026.4	24	1386.4	30	1746.4
7	1326.4	13	2646.4	19	3966.4	25	5286.4	31	6606.4	7	366.4	13	726.4	19	1086.4	25	1446.4	31	1806.4

Clause: The figures are indicative or an estimate only. This is a guide and an allowance for manufacturing tolerances (page 76) should be made.

MoultrEX® Moultruded Fibreglass Grating

What is MoultrEX® Moultruded Fibreglass Grating

Treadwell's MoultrEX® fibreglass moultruded grating is the first open mesh grating ever to combine the high performance values of fibreglass reinforced plastic (FRP) moulded grating with the amazing capabilities of pultrusion. This has been achieved through clever utilisation of pultrusions within the body of the products' load bars and boasts greater amounts of glass in every item than have ever been seen previously. With the introduction of this revolutionary product, a new vista of grating products is now available to meet both the needs and demands of pedestrian and industrial applications.

Engineered to be lighter than metallic alternatives, MoultrEX® is Treadwell's remarkable hybrid of GratEX®'s moulded and GridEX® pultruded systems. It offers excellent load bearing and resilience characteristics, whilst upholding the highest level of resistance to the elements and corrosives.

The product is also aesthetically pleasing and ideally suited to use in public areas where both smaller apertures ensure compliance with relevant codes, and where requirements for a higher level of finish are called for.



MoultrEX® Features and Benefits vs. Traditional Alternatives

	MoultrEX®	Stainless Steel	Galvanised Steel	Aluminium	Polyurethane
Chemical Resistance	•••••	••••	•	•••	••••
Strength	•••••	•••••	•••••	•••••	•••
Lightweight	•••••	•	•	•••••	•••
Electrical Resistance	•••••	•	•	•••••	•••••

MoultrEX® Surface Options

Anti-Slip Surface (Standard).

This surface is most commonly used in industrial applications. It is very hard-wearing and has an extremely effective coefficient of friction (NATA laboratory test report available). Unlike serrated steel grating, the anti-slip surface does not impact on load carrying capacity.



Concave Surface

This is the preferred surface for environments where by-products are commonly caught by serrations, and is hence very often utilised in the food industry. This surface option can also be utilised for guarding options to allow safe handling/contact.



MoultrEX® Moultruded Fibreglass Grating

F-MPG38(25/100)R

Isometric View

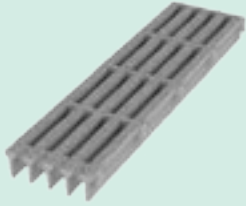

Plan View

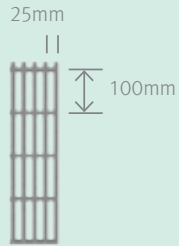

Elevation View

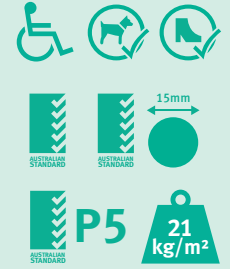
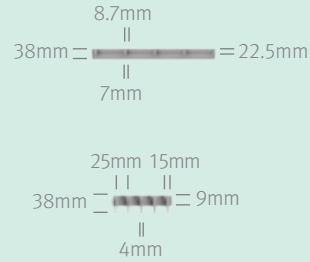

F-MPG38(38/100)R

Isometric View

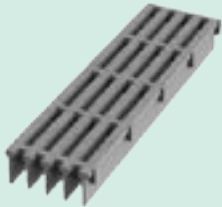

Plan View

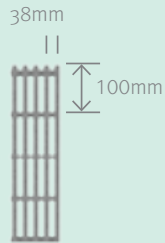

Elevation View

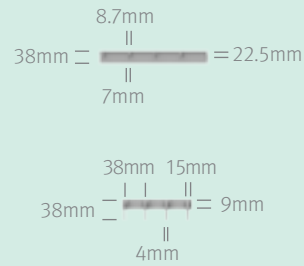

F-MPG50(25/100)R

Isometric View

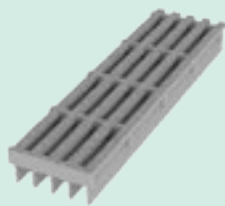

Plan View

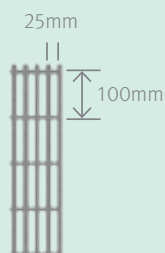

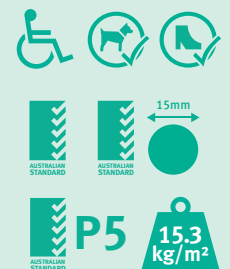
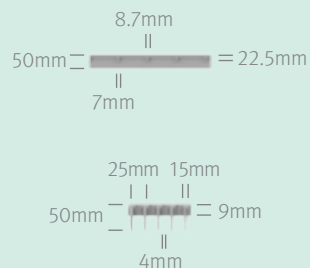

Elevation View







MoultrEX® Installation Methods & Accessories

Treadwell stocks a range of durable 316 stainless steel secure clip options for MoultrEX® Moultruded FRP Grating. Further details regarding fixing types and ordering information can be found on page 92.

Clip - Tops

MoultrEX® M	3D	PLAN	ELEVATION	FASTENING OPTIONS
Hole Diameter: 6mm Material type: 316 st/st Threaded hole: N/A				2

Clamp Underside

J - UNIVERSAL	G	U	V
			
Hole Diameter: N/A Material type: 316 st/st Threaded hole: N/A	Hole Diameter: 6mm Material type: st/st Threaded hole: Yes	Hole Diameter: 8mm Material type: 316 st/st Threaded hole: Yes	Hole Diameter: 8mm Material type: 316 st/st Threaded hole: N/A

Fixing Assembly Combinations

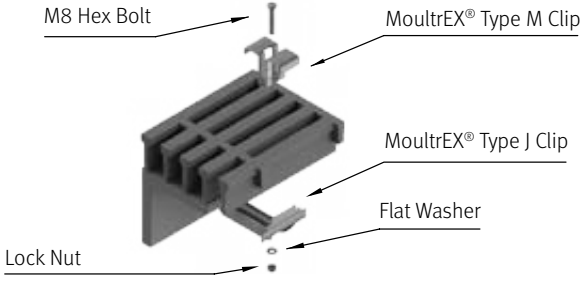
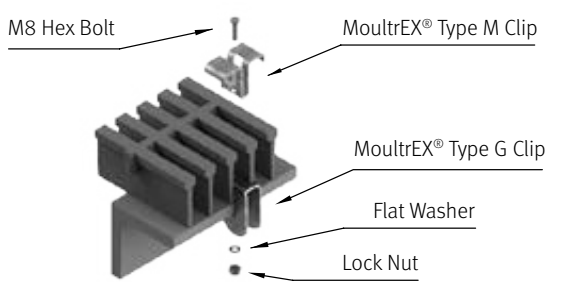
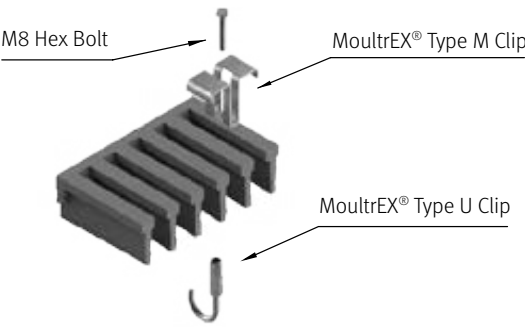
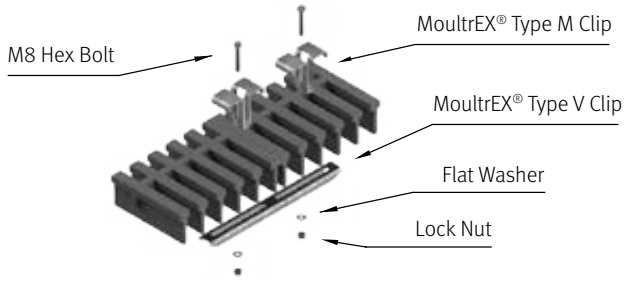
MJ Clip Assembly	MG Clip Assembly
 <p>M8 Hex Bolt</p> <p>MoultrEX® Type M Clip</p> <p>MoultrEX® Type J Clip</p> <p>Flat Washer</p> <p>Lock Nut</p>	 <p>M8 Hex Bolt</p> <p>MoultrEX® Type M Clip</p> <p>MoultrEX® Type G Clip</p> <p>Flat Washer</p> <p>Lock Nut</p>
MU Clip Assembly	MV Clip Assembly
 <p>M8 Hex Bolt</p> <p>MoultrEX® Type M Clip</p> <p>MoultrEX® Type U Clip</p>	 <p>M8 Hex Bolt</p> <p>MoultrEX® Type M Clip</p> <p>MoultrEX® Type V Clip</p> <p>Flat Washer</p> <p>Lock Nut</p>

Please refer to Appendix 6b: MoultrEX® Fasteners Ordering Information (Page 92).

MoultrEX® Moultruded Fibreglass Grating Specification

General

1.0 Scope

1.1 The grating shall conform to the material and fabrication requirements as per this specification.

2.0 Standards/Related documents

- 2.1 The grating system shall conform to the applicable sections of:
- 2.1.1 ASTM E84 Surface Burning Characteristics of Building Materials
 - 2.1.2 ASTM D635 Rate of Burning and/or Extent and Time of Burning of Self-Supporting Plastics in a Horizontal Position.

3.0 Design Criteria

- 3.1 The design criteria of the fibreglass products (FRP) shall be in accordance with governing building codes and generally accepted standards in the FRP industry.
- 3.2 Design live loads shall be of ... kPa uniformly distributed load (or as per building code if more stringent) with a maximum deflection of ... mm at the centre of a single span according to product specifications.

4.0 Submittals

- 4.1 Shop drawings of all fabricated grating panels shall be submitted by Treadwell (unless provided by the client) displaying clearly material sizes, types, styles, product codes and including types and sizes of fasteners as well as a layout if required.
- 4.2 Technical data and sample pieces can also be submitted if required.

5.0 Quality Assurance

Quality surrounds every aspect of Treadwell's commitment to our superior products and efficiency. Treadwell's quality assurance strictly adheres to the high quality control standards placed to conform to relevant specifications, codes, Australian Standards and contractual requirements in a timely manner.

6.0 Product Delivery and Storage

- 6.1 All grating and components or ancillary items shall be fabricated as per the design and piece marked to design drawings.
- 6.2 All manufactured materials shall be delivered in unbroken packages.

Product System

7.0 Manufacturing Process

- 7.1 All fibreglass (FRP) items listed under this section shall be constructed from fibreglass reinforcement and resin of the quality necessary to meet the design requirements and dimensions as specified.
- 7.2 Fibreglass reinforcement shall be continuous roving and shall be in sufficient quantities as required for the application.
- 7.3 Resins shall be ... (refer to page 5) with chemical formulations as necessary to provide the corrosion resistance, strength and any other physical properties as required.
- 7.4 All finished surfaces to be smooth, resin-rich, free of voids and without dry spots, cracks or unreinforced areas and all fibreglass reinforcement shall be well covered with resin to protect against exposure due to weather or wear.
- 7.5 All fibreglass (FRP) items shall be EITHER non-fire retardant OR have a tested flame spread rating of 25 or less when tested in accordance with the ASTM E84 Tunnel Test.

- 7.6 Contact Treadwell regarding specification data relative to products conforming to ASTM D635.
- 7.7 All metal accessories shall be manufactured from (304 or 316) Stainless Steel, 2205 Duplex Stainless Steel, 2507 Super Duplex Stainless Steel, hot dipped galvanised steel or aluminium.
- 7.8 Moulded grating shall be of one piece moulded construction with tops and bottoms of bearing bar and cross bars in the same plane. Grating shall be (either Square, Mini, Rectangular or Solid Surface – choose one)
- 7.9 The fibreglass reinforcement content shall be maintained at 40% (by weight) so as to achieve maximum corrosion resistance.
- 7.10 All fibreglass material shall have an ultraviolet light inhibiting chemical additive to resist UV degradation.
- 7.11 Grating shall be manufactured with a concave profile on top of each bar OR an anti-slip Aluminium Oxide surface to provide optimum slip resistance.
- 7.12 Colour shall be one of the standard Treadwell standard colours (Industrial Green, Safety Yellow, Light Grey or Dark Grey) unless specified as Custom.

8.0 Acceptable Manufacturer

The fibreglass underfoot moultruded grating system shall be manufactured by Treadwell Group Pty Ltd of Australia.

Ordering Information

Code

- | | |
|---|--|
| 1. Nominate the type of grating required | F-MPG = MoultrEX® Moultruded Grating |
| 2. Nominate the depth (mm) required | 38 and 50 |
| 3. Nominate the load bar centres that you require | (25/100) = 25mm x 100mm
(38/100) = 38mm x 100mm |
| 4. Nominate the mesh type required | R = Rectangular Mesh |

Note: This section of the coding is typically separated from the next section of the coding by a dash (-)

- | | |
|---|--|
| 5. Specify the resin, material or type (see page 6) | O = O- Series
I = I- Series
V = V- Series |
| 6. Specify the colour required | G = Industrial Green
Y = Safety Yellow
LG = Light Grey
DG = Dark Grey
CH = Charcoal
C = Custom* |

*In which instance a code and name of the selected colour must be mentioned within the description.

Note: The next section of coding is separated by a slash (/), it isn't required for custom jobs as GratEX® is available in a variety of size panels to suit applications.

- | | |
|-------------------------------------|---|
| 8. Nominate the panel size required | 1 = 1200 mm x 5900 mm
2 = 920 mm x 3055 mm |
|-------------------------------------|---|

Please refer to Appendix 4: MoultrEX® Ordering Codes - page 89

GridEX® Pultruded Fibreglass Grating

What is GridEX® Pultruded Fibreglass Grating

Treadwell's GridEX® pultruded FRP grating systems are designed for specific applications where a standard fibreglass grating system cannot be effectively be utilised. GridEX® offers you options such as selection of open space, bar shape, cross-rod placement, custom fabrication, and custom resin or colour.

A wide variety of bar shapes along with various bearing bar and cross-rod spacings are available depending on the design requirements. Refer to the safe load and deflection charts for our standard selection, and please do not hesitate to contact us for details relating to our custom options.

Most common GridEX® options are available in 25 mm, 38 mm and 50 mm depths. However, Treadwell brings to the market extremely heavy duty versions of GridEX® that offer more durable, stronger and much larger span capacities as the situation calls for.



GridEX® Cross Rod Systems

Treadwell is the only company to offer numerous cross rod systems, allowing you the flexibility to achieve what is required for your application.



Standard (Two Part)



Heavy Duty (Three Part)

GridEX® Surface Options

Ribbed Surface

This is the preferred surface for environments where by-products are commonly caught by serrations, and is hence very often utilised in the food industry. This surface option can also be utilised for wet areas and wash down applications.



Anti-Slip Surface (Standard)

A very hard-wearing surface with an extremely effective coefficient of friction (NATA laboratory test report available) – commonly used in industrial applications. Unlike serrated steel grating, the anti-slip surface does not impact load carrying capacity.



Covered Surface

This non-stock option is very often utilised for applications where high strength covered floors are required. The system is supplied with Checkerplate or Anti-Slip surface bonded to every load bar to ensure performance is maintained in harsh environments.



GridEX® I Type Grating

F-PG25(7.8/5.3)I

Isometric View

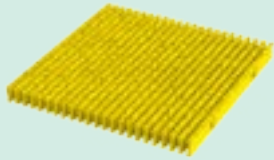

Plan View

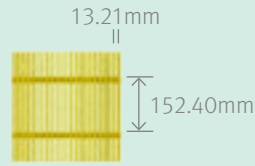

Elevation View



F-PG25(7.8/7.8)I

Isometric View

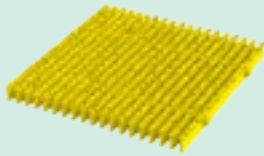

Plan View

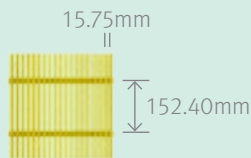

Elevation View

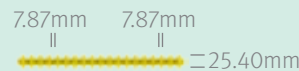

F-PG25(7.8/12)I

Isometric View

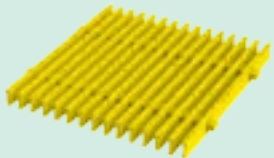

Plan View

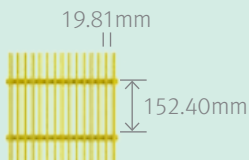

Elevation View

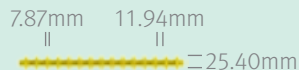

F-PG25(15/10)I

Isometric View

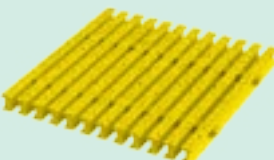

Plan View

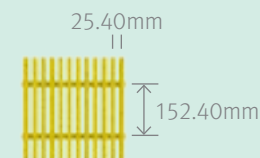

Elevation View



F-PG25(15/15)I

Isometric View

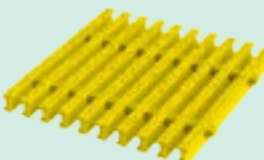

Plan View

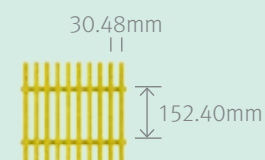



Elevation View



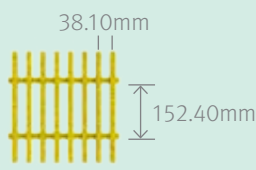
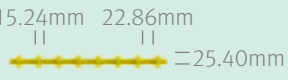

GridEX® I Type Grating

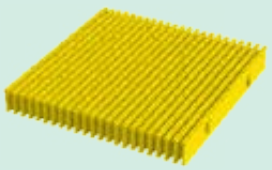
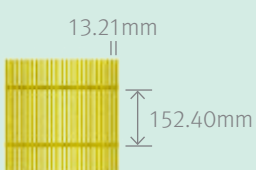

F-PG25(15/22.8)I

<p>Isometric View</p> 	<p>Plan View</p> 	<p>Elevation View</p> 	 <p>P5 12 kg/m²</p>
---	--	--	---

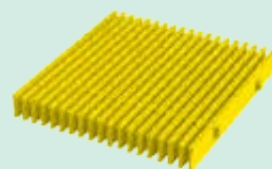
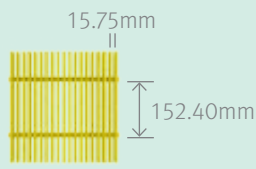

F-PG38(7.8/5.3)I

<p>Isometric View</p> 	<p>Plan View</p> 	<p>Elevation View</p> 	 <p>26 kg/m² P5</p>
---	--	--	---

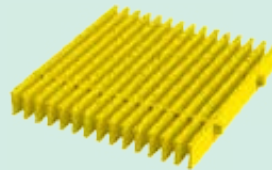
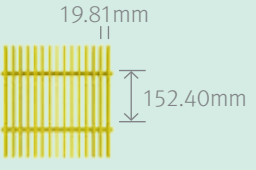
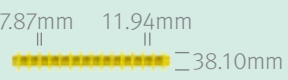

F-PG38(7.8/7.8)I

<p>Isometric View</p> 	<p>Plan View</p> 	<p>Elevation View</p> 	 <p>22.64 kg/m² P5</p>
---	--	--	--

F-PG38(7.8/12)I

<p>Isometric View</p> 	<p>Plan View</p> 	<p>Elevation View</p> 	 <p>18.25 kg/m² P5</p>
---	--	--	--

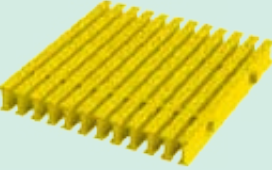
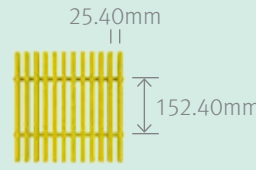
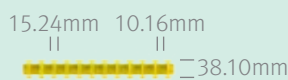
F-PG38(15/10)I

<p>Isometric View</p> 	<p>Plan View</p> 	<p>Elevation View</p> 	 <p>20.6 kg/m² P5</p>
---	--	--	---

GridEX® I Type Grating

F-PG38(15/15)I

Isometric View

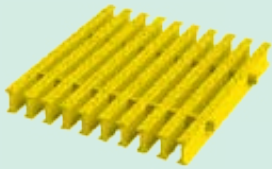

Plan View

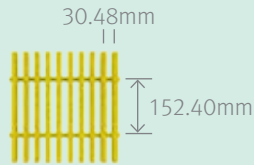

Elevation View



F-PG38(15/22.8)I

Isometric View

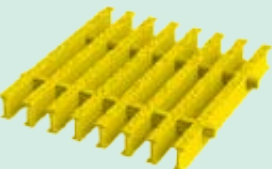

Plan View

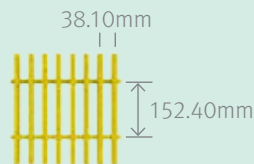

Elevation View

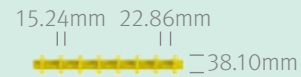

F-PG76(15/10)I

Isometric View

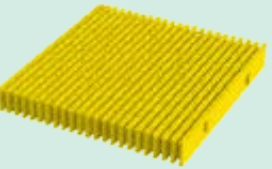

Plan View

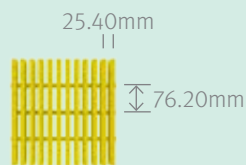

Elevation View

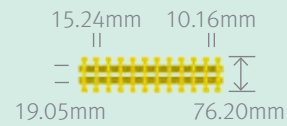

F-PG76(15/15)I

Isometric View

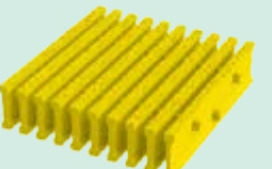

Plan View

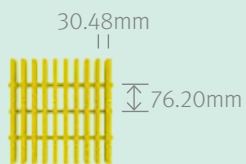

Elevation View

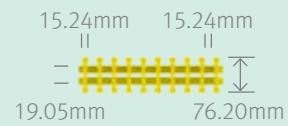

F-PG76(15/22.8)I

Isometric View

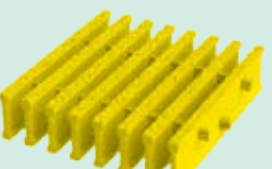

Plan View

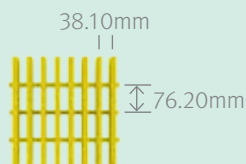

Elevation View

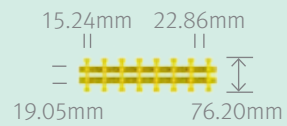

Safe Load & Deflection Charts (mm) - Uniform and Concentrated Line Loads

Grid			Span	Uniform load – ΔU (kpa/m²) – Deflection (mm)										Concentrated line load – ΔC (kN/m) – Deflection (mm)						Safe Load kN		
Open	Closed	Depth		3	5	8	10	13	15	20	25	39	50	100	150	200	250					
F-PG25(5.3/7.8)I																						
60%	40%	25mm	400	ΔU	0.1	0.2	0.3	0.3	0.4	0.5	0.6	0.8	1.2	1.6	3.2	4.8	6.4	8.0	298			
				ΔC	0.4	0.6	1.0	1.3	1.7	1.9	2.6	3.2	5.0	6.4	12.8	59						
			600	ΔU	0.4	0.7	1.0	1.3	1.7	2.0	2.6	3.3	5.1	6.6	13.1	143						
				ΔC	1.0	1.7	2.8	3.5	4.5	5.2	7.0	8.7	13.6	43								
			800	ΔU	1.2	1.9	3.1	3.9	5.0	5.8	7.7	9.6	15.1	82								
				ΔC	2.3	3.9	6.2	7.7	10.0	11.6	15.4	33										
			1000	ΔU	2.8	4.6	7.3	9.2	11.9	13.8	53											
				ΔC	4.4	7.3	11.7	14.7	26													
			1200	ΔU	5.6	9.3	14.9	35														
				ΔC	7.5	12.4	22															
			F-PG25(7.8/7.8)I																			
			40%	60%	25mm	400	ΔU	0.1	0.1	0.2	0.2	0.3	0.3	0.4	0.5	0.8	1.1	2.1	3.2	4.3	5.3	446
ΔC	0.3	0.4					0.7	0.9	1.1	1.3	1.7	2.1	3.3	4.3	8.5	12.8	89					
600	ΔU	0.3				0.4	0.7	0.9	1.1	1.3	1.8	2.2	3.4	4.4	8.8	13.1	214					
	ΔC	0.7				1.2	1.9	2.3	3.0	3.5	4.7	5.8	9.1	11.7	65							
800	ΔU	0.8				1.3	2.1	2.6	3.4	3.9	5.2	6.4	10.1	12.9	124							
	ΔC	1.5				2.6	4.1	5.2	6.7	7.7	10.3	12.9	49									
1000	ΔU	1.8				3.1	4.9	6.1	8.0	9.2	12.3	15.3	79									
	ΔC	2.9				4.9	7.8	9.8	12.7	14.7	39											
1200	ΔU	3.7				6.2	9.9	12.4	53													
	ΔC	5.0				8.3	13.3	32														
F-PG38(15/22.8)I																						
60%	40%	38mm				400	ΔU	0.0	0.1	0.1	0.1	0.2	0.2	0.3	0.4	0.5	0.7	1.4	2.1	2.8	3.5	504
			ΔC	0.2	0.3		0.5	0.6	0.7	0.8	1.1	1.4	2.2	2.8	5.6	8.4	11.3	14.1	100			
			600	ΔU	0.2	0.3	0.4	0.5	0.7	0.8	1.0	1.3	2.0	2.6	5.2	7.8	10.4	13.0	217			
				ΔC	0.4	0.7	1.1	1.4	1.8	2.1	2.8	3.5	5.4	7.0	13.9	66						
			800	ΔU	0.4	0.7	1.2	1.5	1.9	2.2	2.9	3.7	5.7	7.4	14.7	124						
				ΔC	0.9	1.5	2.4	2.9	3.8	4.4	5.9	7.4	11.5	14.7	49							
			1000	ΔU	1.0	1.7	2.7	3.4	4.4	5.1	6.8	8.6	13.3	78								
				ΔC	1.6	2.7	4.4	5.5	7.1	8.2	10.9	13.7	38									
			1200	ΔU	2.1	3.5	5.6	7.0	9.1	10.5	14.0	50										
				ΔC	2.8	4.7	7.5	9.3	12.1	14.0	30											
			1400	ΔU	3.9	6.5	10.4	12.9	36													
				ΔC	4.4	7.4	11.8	14.8	25													
			1600	ΔU	6.6	11.0	27															
				ΔC	6.6	11.0	21															
			F-PG38(7.8/7.8)I																			
			40%	60%	38mm	400	ΔU	0.0	0.0	0.1	0.1	0.1	0.1	0.2	0.2	0.4	0.5	0.9	1.4	1.9	2.3	756
							ΔC	0.1	0.2	0.3	0.4	0.5	0.6	0.8	0.9	1.5	1.9	3.8	5.6	7.5	9.4	150
						600	ΔU	0.1	0.2	0.3	0.3	0.5	0.5	0.7	0.9	1.4	1.7	3.5	5.2	7.0	8.7	325
ΔC	0.3	0.5					0.7	0.9	1.2	1.4	1.9	2.3	3.6	4.6	9.3	13.9	99					
800	ΔU	0.3				0.5	0.8	1.0	1.3	1.5	2.0	2.5	3.8	4.9	9.8	14.7	185					
	ΔC	0.6				1.0	1.6	2.0	2.6	2.9	3.9	4.9	7.7	9.8	74							
1000	ΔU	0.7				1.1	1.8	2.3	3.0	3.4	4.6	5.7	8.9	11.4	116							
	ΔC	1.1				1.8	2.9	3.7	4.7	5.5	7.3	9.1	14.2	58								
1200	ΔU	1.4				2.3	3.7	4.7	6.1	7.0	9.3	11.7	75									
	ΔC	1.9				3.1	5.0	6.2	8.1	9.3	12.5	15.6	45									
1400	ΔU	2.6				4.3	6.9	8.6	11.2	13.0	55											
	ΔC	3.0				4.9	7.9	9.9	12.8	14.8	38											
1600	ΔU	4.4				7.3	11.7	14.7	40													
	ΔC	4.4				7.3	11.7	14.7	32													

GridEX® I Type Specification

General

1.0 Scope

1.1 The grating shall conform to the material and fabrication requirements as per this specification.

2.0 Standards/Related documents

- 2.1 The grating system shall conform to the applicable sections of:
- 2.1.1 ASTM E84 Surface Burning Characteristics of Building Materials
 - 2.1.2 ASTM D635 Rate of Burning and/or Extent and Time of Burning of Self-Supporting Plastics in a Horizontal Position.

3.0 Design Criteria

- 3.1 The design criteria of the fibreglass products (FRP) shall be in accordance with governing building codes and generally accepted standards in the FRP industry.
- 3.2 Design live loads shall be of ... kPa uniformly distributed load (or as per building code if more stringent) with a maximum deflection of ... mm at the centre of a single span according to product specifications.

4.0 Submittals

- 4.1 Shop drawings of all fabricated grating panels shall be submitted by Treadwell (unless provided by the client) displaying clearly material sizes, types, styles, product codes and including types and sizes of fasteners as well as a layout if required.
- 4.2 Technical data and sample pieces can also be submitted if required.

5.0 Quality Assurance

Quality surrounds every aspect of Treadwell's commitment to our superior products and efficiency. Treadwell's quality assurance strictly adheres to the high quality control standards placed to conform to relevant specifications, codes, Australian Standards and contractual requirements in a timely manner.

6.0 Product Delivery and Storage

- 6.1 All grating and components or ancillary items shall be fabricated as per the design and piece marked to design drawings.
- 6.2 All manufactured materials shall be delivered in unbroken packages.

Product System

7.0 Manufacturing Process

- 7.1 All fibreglass (FRP) items listed under this section shall be constructed from fibreglass reinforcement and resin of the quality necessary to meet the design requirements and dimensions as specified.
- 7.2 Fibreglass reinforcement shall be continuous roving and shall be in sufficient quantities as required for the application.
- 7.3 Resins shall be ... (refer to page 5) with chemical formulations as necessary to provide the corrosion resistance, strength and any other physical properties as required.
- 7.4 All finished surfaces to be smooth, resin-rich, free of voids and without dry spots, cracks or unreinforced areas and all fibreglass reinforcement shall be well covered with resin to protect against exposure due to weather or wear.
- 7.5 All fibreglass (FRP) items shall be EITHER non-fire retardant OR have a tested flame spread rating of 25 or less when tested in accordance with the ASTM E84 Tunnel Test.

- 7.7 All metal accessories shall be manufactured from (304 or 316) Stainless Steel, 2205 Duplex Stainless Steel, 2507 Super Duplex Stainless Steel, hot dipped galvanised steel or aluminium.
- 7.8 Pultruded grating components, which will be of pultruded construction shall be high strength and will be constructed utilising continuous roving and continuous strand mat fibreglass reinforcement. A surface veil will be utilised to ensure a resin rich surface is created for superior corrosion and resistance and ultraviolet degradation. Grating shall be – (either Type T, Type I or Bar Type choose one).
- 7.9 Load bars shall be joined with notched cross bars via interlocking methods and the use of chemical bonding.
- 7.10 The fibreglass reinforcement content shall be maintained at 65% (by weight) so as to achieve maximum loading capacity.
- 7.11 All fibreglass material shall have an ultraviolet light inhibiting chemical additive to resist UV degradation.
- 7.12 Grating shall be manufactured with a concave profile, ribbed profile, solid surface on top of each bar OR an anti-slip Aluminium Oxide to provide optimum slip resistance.
- 7.13 Colour shall be either of the standard Treadwell standard colours (Industrial Green, Safety Yellow, Light Grey or Dark Grey).

8.0 Acceptable Manufacturer

The fibreglass underfoot pultruded grating system shall be manufactured by Treadwell Group Pty Ltd of Australia.

Ordering Information

Code

- | | |
|---|---|
| 1. Nominate the type of grating required | F-PG = GridEX® Pultruded Grating |
| 2. Nominate the depth (mm) required | 25, 38 and 76 |
| 3. Nominate the load bar centres that you require | (5.3/7.8) = 5.3mm x 7.8mm
(7.8/5.3) = 7.8mm x 5.3mm
(7.8/7.8) = 7.8mm x 7.8mm
(7.8/12) = 7.8mm x 12mm
(15/10) = 15mm x 10mm
(15/15) = 15mm x 15mm
(15/22.8) = 15mm x 22.8mm |
| 4. Nominate the mesh type required | I = I Type |

Note: This section of the coding is typically separated from the next section of the coding by a dash (-)











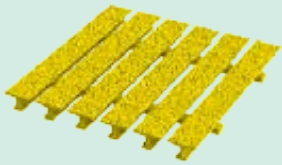
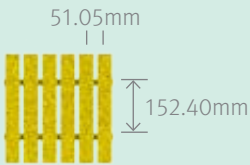
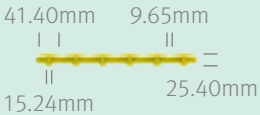



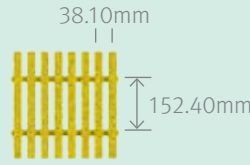

- | | |
|--|--|
| 5. Specify the resin, material or type (see page 6) | O = O- Series
I = I- Series
V = V- Series |
| 6. Specify the colour required
<small>*In which instance a code and name of the selected colour must be mentioned within the description.</small> | G = Industrial Green
Y = Safety Yellow
LG = Light Grey
DG = Dark Grey
CH = Charcoal
C = Custom* |
| 7. Specify the surface style required | CG = Commercial Grade (Grit) Anti-Slip
G = Industrial Grade (Grit) Anti-Slip
MG = Marine Grade (Grit) Anti-Slip
CH = Chequer Plate
P = Plain(Flat) |

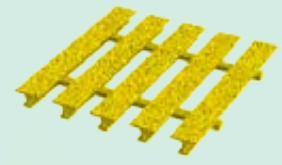
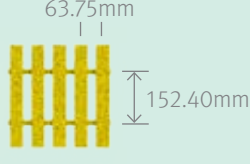
Note: The next section of coding is separated by a slash (/), it isn't required for custom jobs as GridEX® is available in a variety of size panels to suit applications.

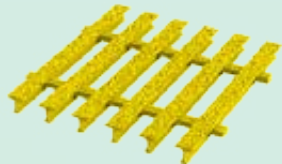
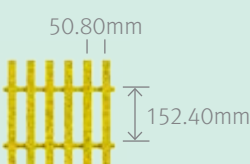
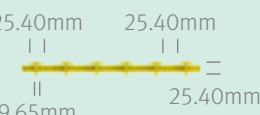
- | | |
|-------------------------------------|---|
| 8. Nominate the panel size required | 1 = 1225 mm x 3665 mm
2 = 920 mm x 3055 mm |
|-------------------------------------|---|

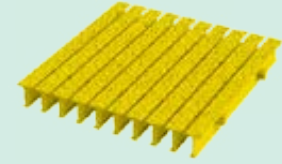
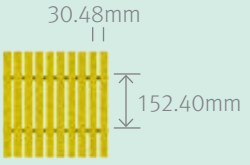
Please refer to Appendix 5: GridEX® Ordering Codes - page 90

GridEX® T Type Grating

F-PG25(40/9.6)T			
<p>Isometric View</p> 	<p>Plan View</p> 	<p>Elevation View</p> 	 
F-PG25(25/12.7)T			
<p>Isometric View</p> 	<p>Plan View</p> 	<p>Elevation View</p> 	 
F-PG25(40/22.3)T			
<p>Isometric View</p> 	<p>Plan View</p> 	<p>Elevation View</p> 	
F-PG25(25/25)T			
<p>Isometric View</p> 	<p>Plan View</p> 	<p>Elevation View</p> 	
F-PG38(25/5)T			
<p>Isometric View</p> 	<p>Plan View</p> 	<p>Elevation View</p> 	 

GridEX® T Type Grating

F-PG38(25/12.7)T

Isometric View

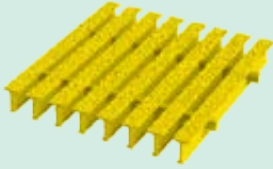

Plan View

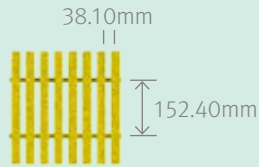

Elevation View

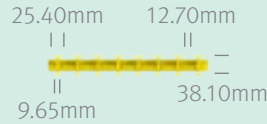

F-PG38(25/25)T

Isometric View

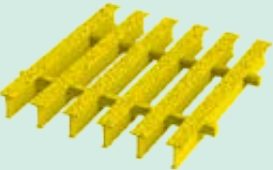

Plan View

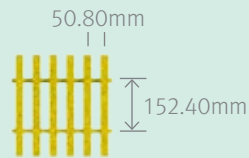

Elevation View



F-PG50(25/12.7)T

Isometric View

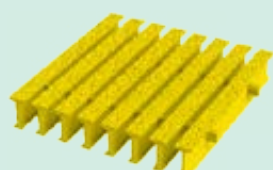

Plan View

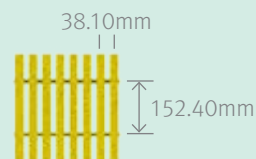

Elevation View

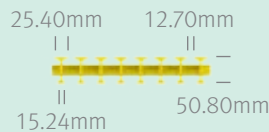

F-PG50(25/25)T

Isometric View

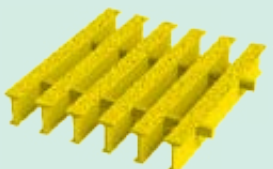

Plan View

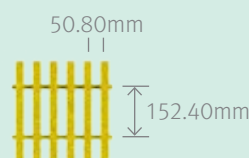

Elevation View

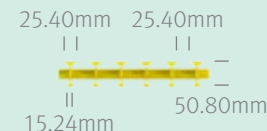

GridEX® T Type Grating

Safe Load & Deflection Charts (mm) - Uniform and Concentrated Line Loads

Grid			Span	Uniform load – ΔU (kpa/m²) – Deflection (mm)							Concentrated line load – ΔC (kN/m) – Deflection (mm)										
Open	Closed	Depth		3	5	8	10	13	15	20	25	39	50	100	150	200	250				
F-PG25(40/22.3)T																					
18%	82%	25mm	400	ΔU	0.1	0.2	0.3	0.3	0.5	0.6	0.7	0.9	1.3	1.7	3.3	4.9	6.6	8.2			
				ΔC	0.4	0.6	1.0	1.4	1.8	2.1	2.8	3.3	5.2	6.6	13.1						
			600	ΔU	0.4	0.7	1.0	1.3	1.7	2.0	2.6	3.3	5.1	6.6	13.1						
				ΔC	1.0	1.7	2.8	3.7	4.6	5.4	7.2	8.9	13.9								
			800	ΔU	1.2	1.9	3.3	4.1	5.2	5.9	7.9	9.8									
				ΔC	2.3	3.9	6.2	7.9	10.2	11.9	15.9										
			1000	ΔU	2.8	4.6	7.5	9.4	12.2	14.1											
				ΔC	4.4	7.5	12.0	14.9													
			1200	ΔU	5.6	9.5	14.9														
				ΔC	7.5	12.4															
			F-PG25(25/25)T																		
			0%	100%	25mm	400	ΔU	0.1	0.2	0.2	0.2	0.4	0.5	0.6	0.7	1.1	1.4	2.7	4.0	5.4	6.7
ΔC	0.3	0.5					0.8	1.1	1.5	1.7	2.3	2.7	4.2	5.4	10.7						
600	ΔU	0.3				0.6	0.8	1.1	1.4	1.6	2.1	2.7	4.1	5.4	10.7						
	ΔC	0.8				1.4	2.3	3.0	3.7	4.4	5.9	7.2	11.3								
800	ΔU	1.0				1.5	2.7	3.3	4.2	4.8	6.4	8.0									
	ΔC	1.9				3.2	5.0	6.4	8.3	9.7	12.9										
1000	ΔU	2.3				3.7	6.1	7.6	9.9	11.5											
	ΔC	3.6				6.1	9.8	12.1													
1200	ΔU	4.6				7.7	12.1														
	ΔC	6.1				10.1															
F-PG50(25/12.7)T																					
50%	50%	50mm				400	ΔU	0.0	0.1	0.1	0.1	0.1	0.2	0.2	0.3	0.4	0.5	1.0	1.6	2.1	2.6
			ΔC	0.1	0.2		0.3	0.4	0.5	0.6	0.8	1.0	1.6	2.1	4.1	6.2	8.3	10.3			
			600	ΔU	0.1	0.2	0.3	0.3	0.4	0.5	0.7	0.9	1.3	1.7	3.4	5.2	6.9	8.6			
				ΔC	0.3	0.5	0.7	0.9	1.2	1.4	1.8	2.3	3.6	4.6	9.2	13.8					
			800	ΔU	0.3	0.5	0.7	0.9	1.2	1.4	1.8	2.3	3.6	4.6	9.0	13.6					
				ΔC	0.5	0.9	1.4	1.8	2.4	2.7	3.6	4.5	7.1	4.5							
			1000	ΔU	0.6	1.0	1.7	2.1	2.7	3.1	4.2	5.2	8.1	9.0							
				ΔC	1.0	1.7	2.7	3.3	4.3	5.0	6.6	8.3	13.0	10.4							
			1200	ΔU	1.2	2.1	3.3	4.1	5.4	6.2	8.3	10.3									
				ΔC	1.7	2.8	4.4	5.5	7.2	8.3	11.0	13.8									
			1400	ΔU	2.2	3.7	6.0	7.4	9.7	11.2	14.9										
				ΔC	2.6	4.3	6.8	8.5	11.1	12.8											
			1600	ΔU	3.8	6.3	10.1	12.6													
				ΔC	3.8	6.3	10.1	12.6													
			F-PG50(25/25)T																		
			33%	66%	50mm	400	ΔU	0.0	0.1	0.1	0.1	0.1	0.2	0.2	0.3	0.4	0.5	1.0	1.6	2.1	2.6
							ΔC	0.1	0.2	0.3	0.4	0.5	0.8	0.8	1.0	1.6	2.1	4.1	6.2	8.3	10.3
						600	ΔU	0.1	0.2	0.3	0.3	0.4	0.5	0.7	0.9	1.3	1.7	3.4	5.2	6.9	8.6
ΔC	0.3	0.5					0.7	0.9	1.2	1.4	1.8	2.3	3.6	4.6	9.2	13.8					
800	ΔU	0.3				0.5	0.7	0.9	1.2	1.4	1.8	2.3	3.6	4.6	9.0	13.6					
	ΔC	0.5				0.9	1.4	1.8	2.4	2.7	3.6	4.5	7.1	4.5							
1000	ΔU	0.6				1.0	1.7	2.1	2.7	3.1	4.2	5.2	8.1	9.0							
	ΔC	1.0				1.7	2.7	3.3	4.3	5.0	6.6	8.3	13.0	10.4							
1200	ΔU	1.2				2.1	3.3	4.1	5.4	6.2	8.3	10.3									
	ΔC	1.7				2.8	4.4	5.5	7.2	8.3	11.0	13.8									
1400	ΔU	2.2				3.7	6.0	7.4	9.7	11.2	14.9										
	ΔC	2.6				4.3	6.8	8.5	11.1	12.8											
1600	ΔU	3.8				6.3	10.1	12.6													
	ΔC	3.8				6.3	10.1	12.6													

GridEX® T Type Specification

General

1.0 Scope

1.1 The grating shall conform to the material and fabrication requirements as per this specification.

2.0 Standards/Related documents

- 2.1 The grating system shall conform to the applicable sections of:
- 2.1.1 ASTM E84 Surface Burning Characteristics of Building Materials
 - 2.1.2 ASTM D635 Rate of Burning and/or Extent and Time of Burning of Self-Supporting Plastics in a Horizontal Position.

3.0 Design Criteria

- 3.1 The design criteria of the fibreglass products (FRP) shall be in accordance with governing building codes and generally accepted standards in the FRP industry.
- 3.2 Design live loads shall be of ... kPa uniformly distributed load (or as per building code if more stringent) with a maximum deflection of ... mm at the centre of a single span according to product specifications.

4.0 Submittals

- 4.1 Shop drawings of all fabricated grating panels shall be submitted by Treadwell (unless provided by the client) displaying clearly material sizes, types, styles, product codes and including types and sizes of fasteners as well as a layout if required.
- 4.2 Technical data and sample pieces can also be submitted if required.

5.0 Quality Assurance

Quality surrounds every aspect of Treadwell's commitment to our superior products and efficiency. Treadwell's quality assurance strictly adheres to the high quality control standards placed to conform to relevant specifications, codes, Australian Standards and contractual requirements in a timely manner.

6.0 Product Delivery and Storage

- 6.1 All grating and components or ancillary items shall be fabricated as per the design and piece marked to design drawings.
- 6.2 All manufactured materials shall be delivered in unbroken packages.

Product System

7.0 Manufacturing Process

- 7.1 All fibreglass (FRP) items listed under this section shall be constructed from fibreglass reinforcement and resin of the quality necessary to meet the design requirements and dimensions as specified.
- 7.2 Fibreglass reinforcement shall be continuous roving and shall be in sufficient quantities as required for the application.
- 7.3 Resins shall be ... (refer to page 5) with chemical formulations as necessary to provide the corrosion resistance, strength and any other physical properties as required.
- 7.4 All finished surfaces to be smooth, resin-rich, free of voids and without dry spots, cracks or unreinforced areas and all fibreglass reinforcement shall be well covered with resin to protect against exposure due to weather or wear.
- 7.5 All fibreglass (FRP) items shall be EITHER non-fire retardant OR have a tested flame spread rating of 25 or less when tested in accordance with the ASTM E84 Tunnel Test.

- 7.7 All metal accessories shall be manufactured from (304 or 316) Stainless Steel, 2205 Duplex Stainless Steel, 2507 Super Duplex Stainless Steel, hot dipped galvanised steel or aluminium.
- 7.8 Pultruded grating components, which will be of pultruded construction shall be high strength and will be constructed utilising continuous roving and continuous strand mat fibreglass reinforcement. A surface veil will be utilised to ensure a resin rich surface is created for superior corrosion and resistance and ultraviolet degradation. Grating shall be – (either Type T or Type I choose one).
- 7.9 Load bars shall be joined with notched cross bars via interlocking methods and the use of chemical bonding.
- 7.10 The fibreglass reinforcement content shall be maintained at 65% (by weight) so as to achieve maximum loading capacity.
- 7.11 All fibreglass material shall have an ultraviolet light inhibiting chemical additive to resist UV degradation.
- 7.12 Grating shall be manufactured with a concave profile, ribbed profile, solid surface on top of each bar OR an anti-slip Aluminium Oxide to provide optimum slip resistance.
- 7.13 Colour shall be either of the standard Treadwell standard colours (Industrial Green, Safety Yellow, Light Grey or Dark Grey).

8.0 Acceptable Manufacturer

The fibreglass underfoot pultruded grating system shall be manufactured by Treadwell Group Pty Ltd of Australia.

Ordering Information

Ordering Information	Code
1. Nominate the type of grating required	F-PG = GridEX® Pultruded Grating
2. Nominate the depth (mm) required	25, 38 and 50
3. Nominate the load bar centres that you require	(22/25) = 22mm x 25mm (25/5) = 25 mm x 5 mm (25/12.7) = 25mm x 12.7mm (40/9.6) = 40mm x 9.6mm (40/22.3) = 40mm x 22.3mm
4. Nominate the mesh type required	T = T Type
Note: This section of the coding is typically separated from the next section of the coding by a dash (-)	
5. Specify the resin, material or type (see page 6)	O = O- Series I = I- Series V = V- Series
6. Specify the colour required <small>*In which instance a code and name of the selected colour must be mentioned within the description.</small>	G = Industrial Green Y = Safety Yellow LG = Light Grey DG = Dark Grey CH = Charcoal C = Custom*
7. Specify the surface style required	CG = Commercial Grade (Grit) Anti-Slip G = Industrial Grade (Grit) Anti-Slip MG = Marine Grade (Grit) Anti-Slip CH = Chequer Plate P = Plain(Flat)
Note: The next section of coding is separated by a slash (/), it isn't required for custom jobs as GridEX® is available in a variety of size panels to suit applications.	
8. Nominate the panel size required	1 = 1200 mm x 5900 mm 2 = 920 mm x 3055 mm

Note: The next section of coding is separated by a slash (/), it isn't required for custom jobs as GridEX® is available in a variety of size panels to suit applications.

8. Nominate the panel size required
- 1 = 1200 mm x 5900 mm
 - 2 = 920 mm x 3055 mm

Please refer to Appendix 5: GridEX® Ordering Codes - page 90

GridEX® Bar Type Grating

F-PG25(15/10)B

Isometric View

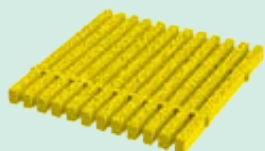

Plan View

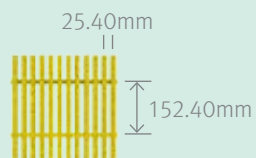

Elevation View

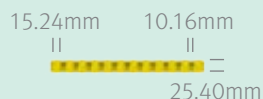

F-PG25(15/15)B

Isometric View

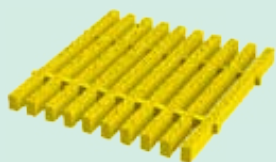

Plan View

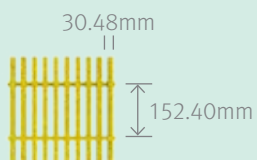

Elevation View

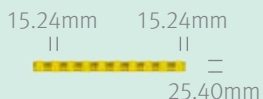

F-PG25(15/23)B

Isometric View

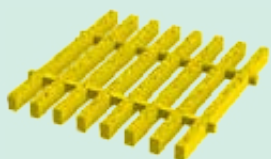

Plan View

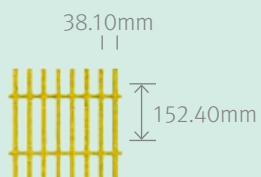

Elevation View

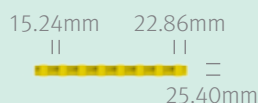

F-PG38(15/10)B

Isometric View

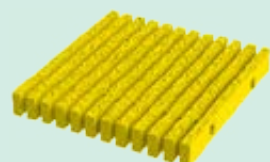

Plan View

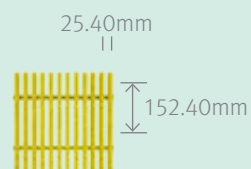

Elevation View

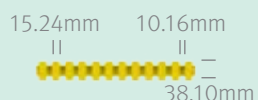

GridEX® Bar Type Grating

F-PG38(15/15)B

Isometric View

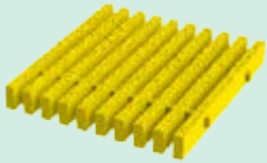

Plan View

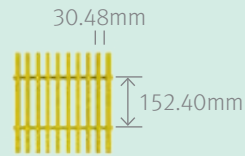

Elevation View



F-PG38(15/23)B

Isometric View

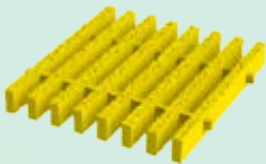

Plan View

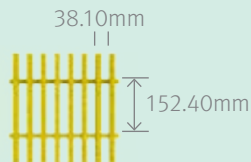

Elevation View



F-PG50(15/10)B

Isometric View

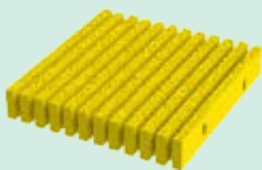

Plan View

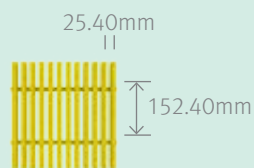

Elevation View



F-PG50(15/15)B

Isometric View

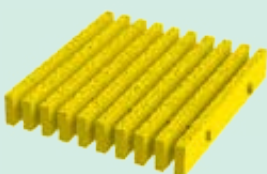

Plan View

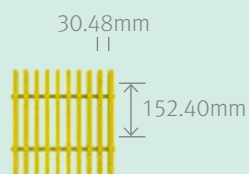

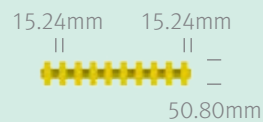

Elevation View



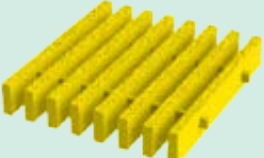
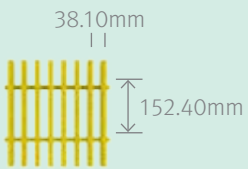

GridEX® Bar Type Grating

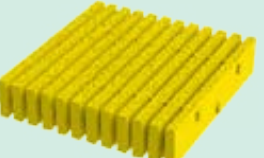
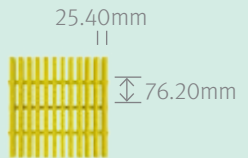

F-PG50(15/23)B

<p>Isometric View</p> 	<p>Plan View</p> 	<p>Elevation View</p> 	
---	--	--	---



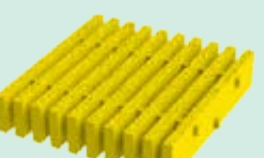
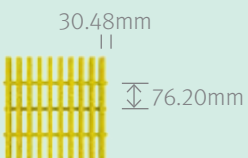

F-PG64(15/10)B

<p>Isometric View</p> 	<p>Plan View</p> 	<p>Elevation View</p> 	
--	---	---	--

F-PG64(15/15)B

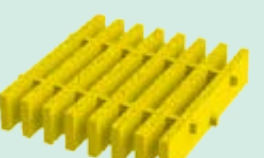
<p>Isometric View</p> 	<p>Plan View</p> 	<p>Elevation View</p> 	
---	--	--	---

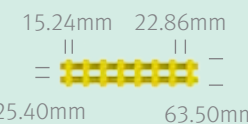
F-PG64(15/23)B

<p>Isometric View</p> 	<p>Plan View</p> 	<p>Elevation View</p> 	
---	--	--	---

GridEX® Bar Type Specification

General

1.0 Scope

1.1 The grating shall conform to the material and fabrication requirements as per this specification.

2.0 Standards/Related documents

- 2.1 The grating system shall conform to the applicable sections of:
- 2.1.1 ASTM E84 Surface Burning Characteristics of Building Materials
 - 2.1.2 ASTM D635 Rate of Burning and/or Extent and Time of Burning of Self-Supporting Plastics in a Horizontal Position.

3.0 Design Criteria

- 3.1 The design criteria of the fibreglass products (FRP) shall be in accordance with governing building codes and generally accepted standards in the FRP industry.
- 3.2 Design live loads shall be of ... kPa uniformly distributed load (or as per building code if more stringent) with a maximum deflection of ... mm at the centre of a single span according to product specifications.

4.0 Submittals

- 4.1 Shop drawings of all fabricated grating panels shall be submitted by Treadwell (unless provided by the client) displaying clearly material sizes, types, styles, product codes and including types and sizes of fasteners as well as a layout if required.
- 4.2 Technical data and sample pieces can also be submitted if required.

5.0 Quality Assurance

Quality surrounds every aspect of Treadwell's commitment to our superior products and efficiency. Treadwell's quality assurance strictly adheres to the high quality control standards placed to conform to relevant specifications, codes, Australian Standards and contractual requirements in a timely manner.

6.0 Product Delivery and Storage

- 6.1 All grating and components or ancillary items shall be fabricated as per the design and piece marked to design drawings.
- 6.2 All manufactured materials shall be delivered in unbroken packages.

Product System

7.0 Manufacturing Process

- 7.1 All fibreglass (FRP) items listed under this section shall be constructed from fibreglass reinforcement and resin of the quality necessary to meet the design requirements and dimensions as specified.
- 7.2 Fibreglass reinforcement shall be continuous roving and shall be in sufficient quantities as required for the application.
- 7.3 Resins shall be ... (refer to page 5) with chemical formulations as necessary to provide the corrosion resistance, strength and any other physical properties as required.
- 7.4 All finished surfaces to be smooth, resin-rich, free of voids and without dry spots, cracks or unreinforced areas and all fibreglass reinforcement shall be well covered with resin to protect against exposure due to weather or wear.
- 7.5 All fibreglass (FRP) items shall be EITHER non-fire retardant OR have a tested flame spread rating of 25 or less when tested in accordance with the ASTM E84 Tunnel Test.

- 7.7 All metal accessories shall be manufactured from (304 or 316) Stainless Steel, 2205 Duplex Stainless Steel, 2507 Super Duplex Stainless Steel, hot dipped galvanised steel or aluminium.
- 7.8 Pultruded grating components, which will be of pultruded construction shall be high strength and will be constructed utilising continuous roving and continuous strand mat fibreglass reinforcement. A surface veil will be utilised to ensure a resin rich surface is created for superior corrosion and resistance and ultraviolet degradation. Grating shall be – (either Type T or Type I choose one).
- 7.9 Load bars shall be joined with notched cross bars via interlocking methods and the use of chemical bonding.
- 7.10 The fibreglass reinforcement content shall be maintained at 65% (by weight) so as to achieve maximum loading capacity.
- 7.11 All fibreglass material shall have an ultraviolet light inhibiting chemical additive to resist UV degradation.
- 7.12 Grating shall be manufactured with a concave profile, ribbed profile, solid surface on top of each bar OR an anti-slip Aluminium Oxide to provide optimum slip resistance.
- 7.13 Colour shall be either of the standard Treadwell standard colours (Industrial Green, Safety Yellow, Light Grey or Dark Grey).

8.0 Acceptable Manufacturer

The fibreglass underfoot moulded grating system shall be manufactured by Treadwell Group Pty Ltd of Australia.

Ordering Information

Code

- | | |
|---|---|
| 1. Nominate the type of grating required | F-PG = GridEX® Pultruded Grating |
| 2. Nominate the depth (mm) required | 25, 38, 50 and 64 |
| 3. Nominate the load bar centres that you require | (15/10) = 15mm x 10mm
(15/15) = 15mm x 15mm
(15/23) = 15mm x 23mm |
| 4. Nominate the mesh type required | B = Bar Type |

Note: This section of the coding is typically separated from the next section of the coding by a dash (-)

- | | |
|---|--|
| 5. Specify the resin, material or type (see page 6) | O = O- Series
I = I- Series
V = V- Series |
| 6. Specify the colour required
*In which instance a code and name of the selected colour must be mentioned within the description. | G = Industrial Green
Y = Safety Yellow
LG = Light Grey
DG = Dark Grey
CH = Charcoal
C = Custom* |

- | | |
|---------------------------------------|--|
| 7. Specify the surface style required | CG = Commercial Grade (Grit) Anti-Slip
G = Industrial Grade (Grit) Anti-Slip
MG = Marine Grade (Grit) Anti-Slip
CH = Chequer Plate
P = Plain(Flat) |
|---------------------------------------|--|

Note: The next section of coding is separated by a slash (/), it isn't required for custom jobs as GridEX® is available in a variety of size panels to suit applications.

- | | |
|-------------------------------------|---|
| 8. Nominate the panel size required | 1 = 1200 mm x 5900 mm
2 = 920 mm x 3055 mm |
|-------------------------------------|---|

Please refer to Appendix 5: GridEX® Ordering Codes - page 90

GridEX® Stair Treads and Landings



Treadwell's range of GridEX® Stair Treads includes both open surface and closed surface options, with a range of surface patterns, colour and leading edge nosing options.

GridEX® Stair Treads are normally implemented in applications where there are greater load bearing and strength capacities required that other grating variations cannot offer. The GridEX® Treads are available in all bar types and dimensional variations.

All GridEX® Premium and Standard Stair Tread options are moulded with the Solid Leading Edge Nosing as an integrated single stage operation. This increases the rigidity and durability of the entire leading edge, ensuring reliable performance in high traffic scenarios. All the treads with abrasive leading edge nosings are manufactured to conform with AS-1657 - 2013.

The GridEX® Stair Tread nosings (premium treads only) are typically stocked in colours that contrast by 30% with the primary tread colour. This ensures maximum visual awareness of the stair treads forward edge for operators utilising the stairways and consequently enhancing the OHS safety ratings.

Treadwell recommends that leading edge nosings are specified when ordering GridEX® Stair Treads as the safety risks associated with elevated work areas or walkways is significantly increased without them.

NOTE: A bearing surface of at least 40mm is recommended at either side of GridEX® Stair Treads. Compliance with AS 1657-2013 requires a tread depth of less than 225mm.

Selecting a tread with lasting non-slip properties, resilience to corrosion and proven long term cost advantages can help you enhance safety in the workplace by reducing the chance of slips, trips and falls.







GridEX® Installation Methods & Accessories

Treadwell stocks a range of durable 316 stainless steel secure clip options for GridEX® Pultruded FRP Grating. Further details regarding fixing types and ordering information can be found on page 96.

Clip - Tops

ITEM	PROFILES	HOLE DIAMETER	MATERIAL TYPE	THREADED HOLE	FASTENING OPTIONS
GridEX® M		6mm	316 st/st	N/A	2

Clamp Underside

J - UNIVERSAL	G	U	V
			
Hole Diameter: N/A Material type: 316 st/st Threaded hole: N/A	Hole Diameter: 6mm Material type: st/st Threaded hole: Yes	Hole Diameter: 8mm Material type: 316 st/st Threaded hole: Yes	Hole Diameter: 8mm Material type: 316 st/st Threaded hole: N/A

Fixing Assembly Combinations

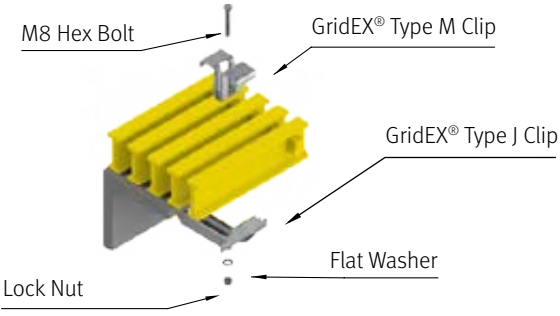
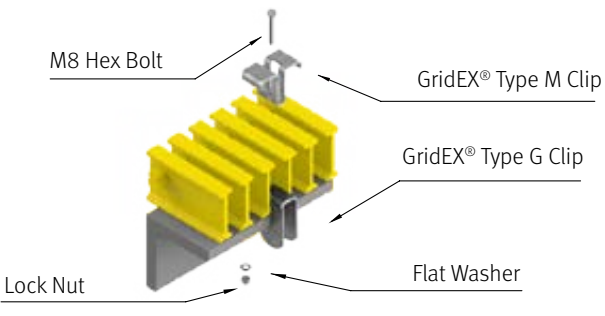
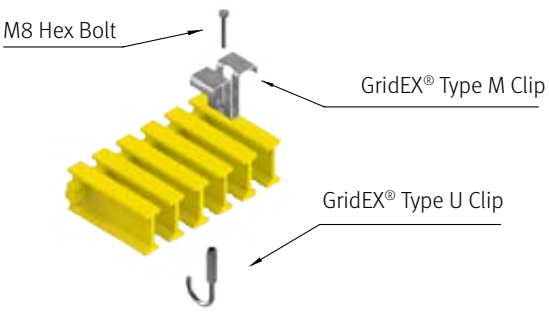
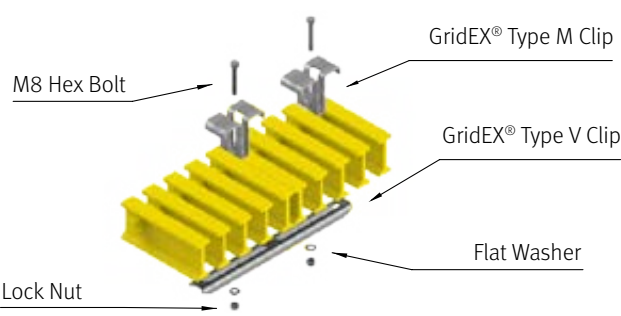
MJ Clip Assembly	MG Clip Assembly
 <p>M8 Hex Bolt</p> <p>GridEX® Type M Clip</p> <p>GridEX® Type J Clip</p> <p>Flat Washer</p> <p>Lock Nut</p>	 <p>M8 Hex Bolt</p> <p>GridEX® Type M Clip</p> <p>GridEX® Type G Clip</p> <p>Flat Washer</p> <p>Lock Nut</p>
MU Clip Assembly	MV Clip Assembly
 <p>M8 Hex Bolt</p> <p>GridEX® Type M Clip</p> <p>GridEX® Type U Clip</p>	 <p>M8 Hex Bolt</p> <p>GridEX® Type M Clip</p> <p>GridEX® Type V Clip</p> <p>Flat Washer</p> <p>Lock Nut</p>

Please refer to Appendix 6c: GridEX® Fasteners Ordering Information (Page 93).

P-Series® Phenolic Grating

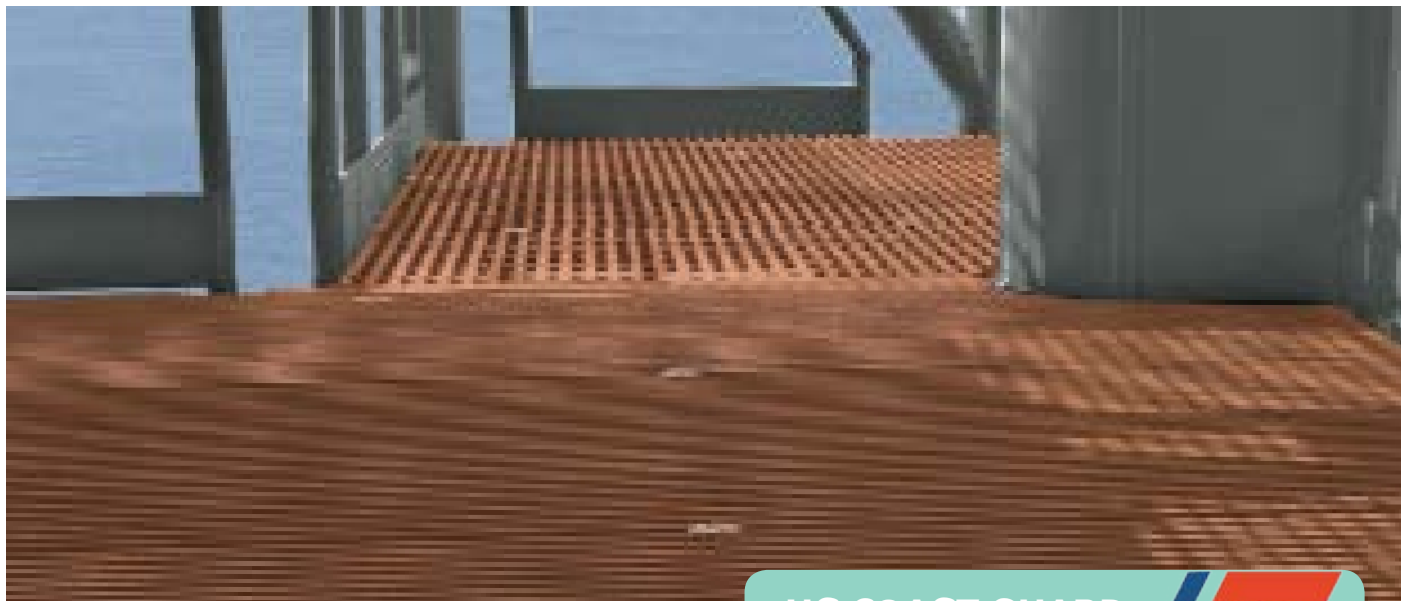

**US COAST GUARD
APPROVED**



Treadwell's P-Series® Phenolic fibreglass or FRP grating is the ultimate choice for applications where fire risk is prevalent and when smoke cannot be allowed to develop.

Treadwell, through the employment of the most advanced production equipment and the use of the highest quality raw materials, has developed this unique range of leading offshore composite grating products. EX-Series® Phenolic Grating, which boasts US Coast Guard approval, is acceptable for use in areas and applications as outlined in the US Coast Guard Safety Manual Vol III.

Composite Grating with the Strength of Steel

EX-Series® Phenolic Grating can span up to 70% more than that of equivalent size standard steel grating. Furthermore, P-Series® will not yield and will return to its original shape if design loads are exceeded.

Ease of Installation

EX-Series® Phenolic Grating is only 65% of the weight of steel bar grating and often, can be manually installed with ease.

Safety Enhancing Anti-Slip Surface

This system unique to EX-Series® Grating Systems means that load bars are broader than those of metal grating and are far less fatiguing than conventional steel bar grating and not dangerously sharp like serrated surface grating.

Extreme Fire and Impact Resistance

EX-Series® Phenolic Grating systems, which is laminated by an outer layer of resin rich Phenolic providing ultimate fire resistance, ensures extreme strength is maintained.

Typical Applications

- Jetties, wharfs & marine structures
- Offshore production platforms
- Offshore drilling platforms
- Grating
- Refineries
- Industrial/processing plants
- Shipboard applications
- Public Transport i.e. tunnels

Standard Panel Sizes

GratEX®	1225 mm x 3665 mm
	920 mm x 3055 mm
GridEX®	1524 mm x 6096 mm

Other custom panels sizes are achievable and readily available.

Installation Methods

Treadwell offers a range of Installation fixing systems designed for offshore wave zone environments as well as for standard industrial applications – refer to pages 38-41, 50, 68 and 80 for StormChief® system, which has a long-standing history of outstanding performance in the offshore industry.

Standard Colours



Antique Brown



Antique Yellow

P-Series® Phenolic Grating Specification

General

1.0 Scope

1.1 The grating shall conform to the material and fabrication requirements as per this specification.

2.0 Standards/Related documents

- 2.1 The grating system shall conform to the applicable sections of:
- 2.1.1 ASTM E84 Surface Burning Characteristics of Building Materials
 - 2.1.2 ASTM D635 Rate of Burning and/or Extent and Time of Burning of Self-Supporting Plastics in a Horizontal Position.

3.0 Design Criteria

- 3.1 The design criteria of the fibreglass products (FRP) shall be in accordance with governing building codes and generally accepted standards in the FRP industry.
- 3.2 Design live loads shall be of ... kPa uniformly distributed load (or as per building code if more stringent) with a maximum deflection of ... mm at the centre of a single span according to product specifications.

4.0 Submittals

- 4.1 Shop drawings of all fabricated grating panels shall be submitted by Treadwell (unless provided by the client) displaying clearly material sizes, types, styles, product codes and including types and sizes of fasteners as well as a layout if required.
- 4.2 Technical data and sample pieces can also be submitted if required.

5.0 Quality Assurance

Quality surrounds every aspect of Treadwell's commitment to our superior products and efficiency. Treadwell's quality assurance strictly adheres to the high quality control standards placed to conform to relevant specifications, codes, Australian Standards and contractual requirements in a timely manner.

6.0 Product Delivery and Storage

- 6.1 All grating and components or ancillary items shall be fabricated as per the design and piece marked to design drawings.
- 6.2 All manufactured materials shall be delivered in unbroken packages.

Product System

7.0 Manufacturing Process

- 7.1 All fibreglass (FRP) items listed under this section shall be constructed from fibreglass reinforcement and resin of the quality necessary to meet the design requirements and dimensions as specified.
- 7.2 Fibreglass reinforcement shall be continuous roving and shall be in sufficient quantities as required for the application.
- 7.3 Resins shall be ... (refer to page 5) with chemical formulations as necessary to provide the corrosion resistance, strength and any other physical properties as required.
- 7.4 All finished surfaces to be smooth, resin-rich, free of voids and without dry spots, cracks or unreinforced areas and all fibreglass reinforcement shall be well covered with resin to protect against exposure due to weather or wear.
- 7.5 All fibreglass (FRP) items shall be EITHER non-fire retardant OR have a tested flame spread rating of 25 or less when tested in accordance with the ASTM E84 Tunnel Test.

- 7.7 All metal accessories shall be manufactured from (304 or 316) Stainless Steel, 2205 Duplex Stainless Steel, 2507 Super Duplex Stainless Steel, hot dipped galvanised steel or aluminium.
- 7.8 Pultruded grating components, which will be of pultruded construction shall be high strength and will be constructed utilising continuous roving and continuous strand mat fibreglass reinforcement. A surface veil will be utilised to ensure a resin rich surface is created for superior corrosion and resistance and ultraviolet degradation. Grating shall be – (either Type T or Type I choose one).
- 7.9 Load bars shall be joined with notched cross bars via interlocking methods and the use of chemical bonding.
- 7.10 The fibreglass reinforcement content shall be maintained at 65% (by weight) so as to achieve maximum loading capacity.
- 7.11 All fibreglass material shall have an ultraviolet light inhibiting chemical additive to resist UV degradation.
- 7.12 Grating shall be manufactured with a concave profile, ribbed profile, solid surface on top of each bar OR an anti-slip Aluminium Oxide to provide optimum slip resistance.
- 7.13 Colour shall be either of the standard Treadwell standard colours (Industrial Green, Safety Yellow, Light Grey or Dark Grey).

8.0 Acceptable Manufacturer

The fibreglass underfoot pultruded grating system shall be manufactured by Treadwell Group Pty Ltd of Australia.

Ordering Information

Code

- | | | |
|----|--|---|
| 1. | Nominate the type of grating required | F-MG = GratEX® Moulded Grating
F-PG = GridEX® Pultruded Grating |
| 2. | Nominate the depth (mm) required | 25 and 38 |
| 3. | Nominate the load bar centres that you require | (38/38) = 38mm x 38mm for Square Mesh
(7.8/12) = 7.8mm x 12mm for GridEX® I Type |

Note: This section of the coding is typically separated from the next section of the coding by a dash (-)

- | | | |
|----|-------------------------------------|-------------------------------|
| 4. | Nominate the mesh type required | I = I Type
S = Square Mesh |
| 5. | Specify the resin, material or type | P = P-Series |

Example: F-PG38(15/10)IP

All Treadwell FRP grating products are available to order with any colour that you may specify.

While we carry one of the broadest offerings of commonly used colours, our FRP grating range offers unlimited flexibility when trying to match to an existing colour scheme. All of the grating types that make up the Treadwell range can be requested in a custom or RAL matched colour.

A selection of colours is offered below. It is important to note that our range is NOT limited to these colours and not all products may be immediately available in the colours listed below.

Standard Colours



Colour Palette

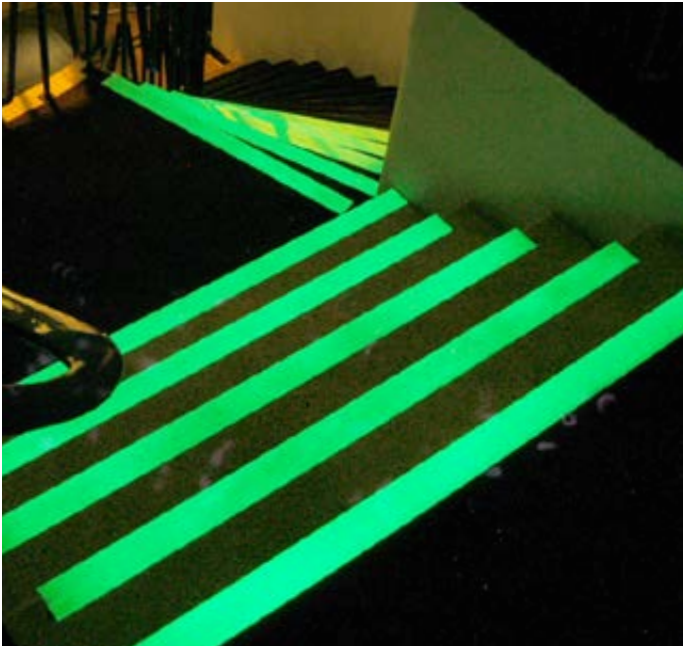

Glow in the Dark Colours

Treadwell is also proud to offer innovative glow-in-the-dark products which use an embedded inorganic photo luminescent pigment that creates a green/yellow glow when active. The pigment is non-toxic, non-radioactive, and can be recharged repeatedly during the life of the product.

These products are an effective safety solution for both outdoor and indoor applications, with greater visibility for many hours after the light source has been removed.

The photo luminescent pigment is fully recharged after 5 minutes of exposure to sunlight, 8 minutes at dusk, or 10 minutes in fluorescent light; depending on the strength and nature of the light source. The higher the UV output, the brighter the illumination.

Two-Tone Colour Configurations

Colours can also be combined to create a two-tone configuration. Contrasting colours can be applied on (but not limited to):

- On the nosing and vertical lip of a step cover, increasing notice to the leading edge of a stair.
- On the perimeter of a walkway cover where a change in surface texture and colour signifies a safe walk zone.
- On RungSAFE Covers.

In addition, it is an economical alternative to full photo luminescent covers combined with a solid colour. Not only do you have a two-tone configuration in the light, but also the benefit of glow in the dark when the light source is removed.

Descriptive Markings

Overhead safety warnings and signage can actually create a slip, trip and fall situation when the person fails to look down while walking. Worse yet, in the event of a fire or emergency, smoke and darkness often conceal overhead signage and directional guidance.

The image or message can be embedded into the cover, not just printed on the surface, so it will last for the life of the product and not wear off.

Treadwell can also incorporate your company logo and other custom graphics into the surface without affecting slip performance.

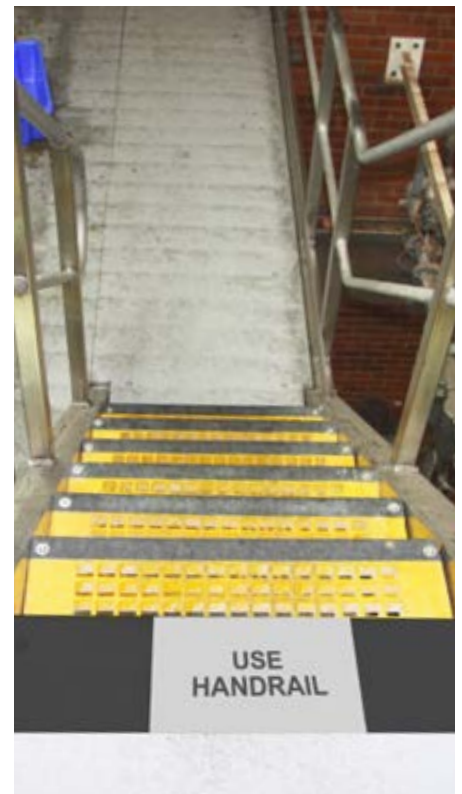

Grating Grit Grades

Cover Grit Options

Every grating surface has Treadwell's unique layer of resin surface with embedded grit that characterises its high traction and safety traits. Depending on application, our range of grit covers can offer the highest anti-slip properties available on the market to smaller grits where specified.

Hardness of Grit

We incorporate fused alumina into all of our anti-slip products. Measuring at 9.4 on Moh's Hardness Scale, most tapes and paints which contain quartz or silica (in other words, sand) pale in comparison. These score a soft aggregate of 6-7 that will quickly wear away under foot traffic, leaving your surface more open to hazards.

Mohs Hardness Scale	
Diamond	10.0
Fused Alumina	9.4
Quartz Sand Most Anti-Slip Products Including Tapes	6-7

Coefficient of Friction (COF)

GratEX® products have been tested according to AS/ NZS 4586 and HB 197 standards.



Ten Standards Grades



Barefoot Grade



Pedestrian Grade

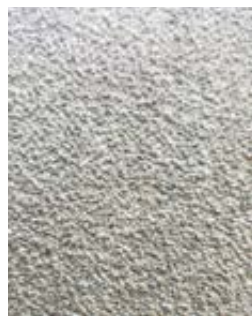

Sidewalk Grade



Standard Grade

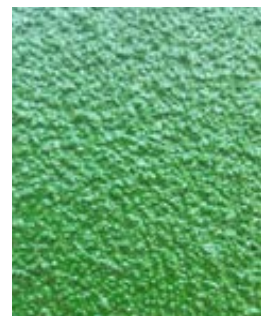

Wet-Area Grade



Industrial Grade

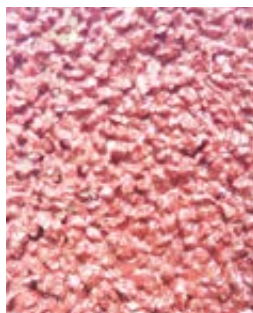

Medium Duty Grade



Heavy Duty Grade



Marine Grade



Offshore Grade

HygiGR8®

What is HygiGR8®

The Treadwell HygiGR8® range has been developed specifically to service the food and beverage processing industry. With an emphasis on streamlining cleaning processes and addressing the major hygiene issues faced in food processing operations, HygiGR8® is a comprehensive solution when developing or renovating food manufacturing processes.

HygiGR8® incorporates a unique blend of solid top and open grating technology. This provides a solution to the major hygiene issue of entrapped produce between support members and grating. This is achieved through the careful layout of HygiGR8® panels to ensure the solid top section of customisable width around the edge of each panel is located so that the beams that make up the substructure are covered by the solid band.

The grating system is manufactured using premium food grade polyester resin tested to ensure food standard compatibility. Each panel is post cured and detergent washed prior to packaging for despatch.

Treadwell certifies that our food-grade HygiGR8® grating products are acceptable for use in all food and beverage processing facilities when properly installed and maintained as an ergonomic or anti-slip walking floor surface or covering. These products meet USDA acceptance requirements for floor surfaces.

The system is unique in its capabilities and can be adapted to any floor plan. HygiGR8® also incorporates treads manufactured to the same standards which mean any flooring incorporating walkways and stairways is completely covered by HygiGR8®.



HygiGR8® Features and Benefits vs. Traditional Alternatives

	HygiGR8®	Stainless Steel	Galvanised Steel	Aluminium	Polyurethane
Chemical Resistance	● ● ● ● ●	● ● ● ● ●	●	● ● ●	● ● ● ● ●
Strength	● ● ● ● ●	● ● ● ● ● ●	● ● ● ● ● ●	● ● ● ● ● ●	● ● ●
Lightweight	● ● ● ● ●	●	●	● ● ● ● ●	● ● ●
Electrical Resistance	● ● ● ● ●	●	●	●	● ● ● ● ●
Cleaning	● ● ● ● ●	● ● ●	● ● ●	● ● ●	●
Hygiene	● ● ● ● ●	● ● ● ● ●	●	● ●	● ● ● ● ●

HygiGR8® Surface Options

Anti-Slip Surface. HygiGR8® is recommended with a gritted anti-slip surface to ensure maximum grip in situations where there are typically moisture and slippery residues. It has an extremely effective coefficient of friction and is very hard-wearing (NATA laboratory test report available).



Concave Surface. HygiGR8® can also be ordered with the concave surface option. This ensures efficient and easier to clean environments where by-products are commonly caught between serrations. However, the anti-slip properties are not as profound as the gritted surface.



What is EX-Series® Conductive Grating?

FRP gratings are typically non-conductive and this can sometimes present a safety issue when in a sparking sensitive environment due to the build-up of static electricity.

The black carbon surface in Treadwell's conductive grating is specially formulated to discharge static build-up on FRP grating surfaces in areas where static build-up presents a significant risk. When properly grounded, the conductive surface provides solutions that can be typically applied in areas where there is highly sensitive electrical equipment, munitions, chemical or petro chemicals present.

Treadwell's conductive grating drains off the build-up of unwanted, dangerous static electricity when grounded. This specialised grating produces an electrical resistance of less than 26-kilo-ohms per foot, while retaining other desirable characteristics of conventional FRP moulded grating.

The Treadwell Moulded Carbon Top can be applied to any of the grating products specified in our range and can be combined with any of our resin formulations.







Based on NFPA 77

Recommended 4 grounding attachments

- Average Surface Resistivity - 2.5×10^3 ohms to 1×10^6 ohms per lineal foot
- Average Resistance to Ground - $<10^8$ ohms

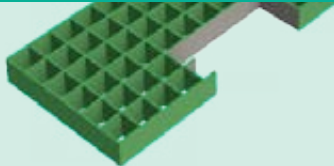
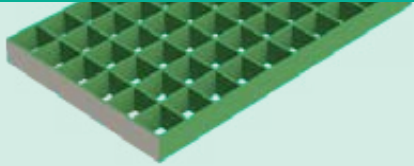

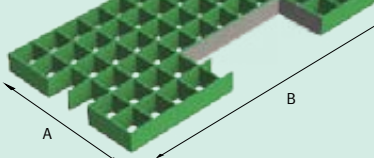
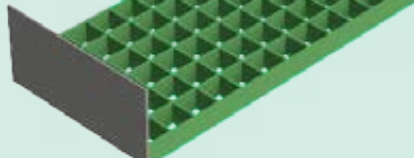
Terminology

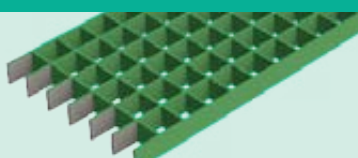
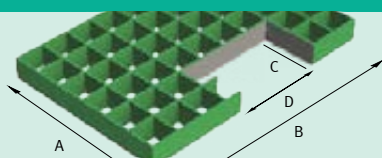
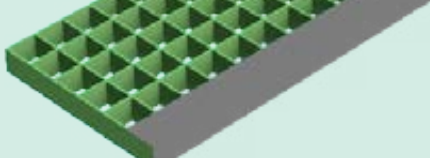
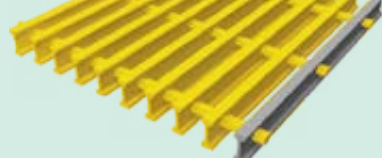
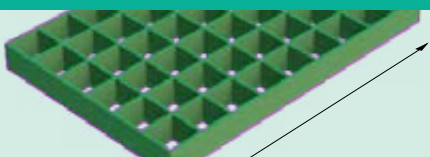
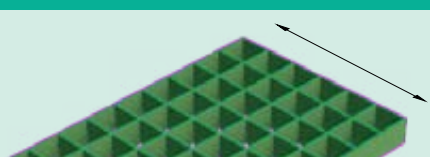
<p>Cross Bar A section fixed at right angles to the Load Bar designed to provide lateral strength — GridEX® pultruded grating is constructed using such members.</p>	<p>Cut Out Grating area removed from panels to permit passage of columns, handrail, pipes and structural items.</p>	<p>Edge Bar Banding The process of chemically bonding Load Bars (non-load bearing) to the cross bars after trimming to size to provide a uniform appearance on all sides of a grating panel. Available on GratEX® products; contact technical assistance for further details.</p>
		
<p>Exact Size Refers to the requirement to manufacture the panels to an exact dimension and not to be adjusted to the nearest width across the standard pattern of the load bars.</p>	<p>Gross Area Total area including areas cut to waste (A x B).</p>	<p>Kick Plate A large flat section chemically bonded to side or end of panel and around cut-outs where specified. Nominal height is 100 mm above working surface.</p>
		
<p>Penetrations Cut out but within the grating panel as opposed to being on the edge.</p>	<p>Prongs In the case of GratEX®, this describes a panel cut that does not run adjacent to a load bar.</p>	<p>Net Area The area of panel remaining after deducting areas cut to waste $[AxB]-[Cx D]$.</p>
		
<p>Nosing The section on the leading edge of a stair tread or (top stair) loading panel to assist slip resistance and to give a clear visual indication of the edge of stair treads and loadings.</p>	<p>Load Bar A load carrying section from which grating is constructed spanning between two supports. GratEX® moulded grating consists of Load Bars in both directions, hence the product's exceptional bi-directional strength.</p>	
		
<p>Length of Span Overall dimension of a panel measured parallel with load bar typically indicated by this symbol "↔". In the case of GratEX® (due to load bars being bi-directional), this is either the span or the longest dimension.</p>	<p>Width The overall dimension of a panel – in the case of GratEX®, this is the opposite dimension to the span, or the smaller dimension and in the case of GridEX®, this is the dimension measured at right angles to the load bars, even if greater than the length.</p>	
		

Installation Suggestions & Tools

Installing and modifying or fabricating FRP products, and in particular grating, can be done with ease on site if needed, provided you have the right tools to do so. To assist you with ensuring you are equipped properly, we have provided the following information and guidelines.

1 Measure & Mark

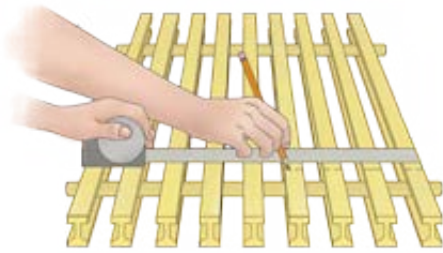

Remember to measure twice, then cut once!

2 Check & Cut

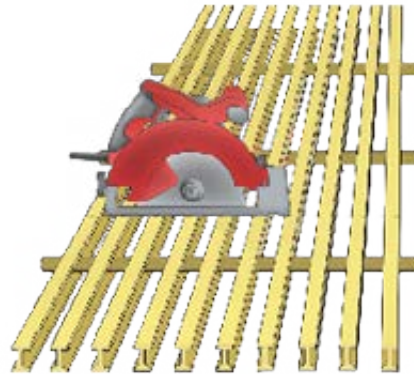

3 Seal & Fasten

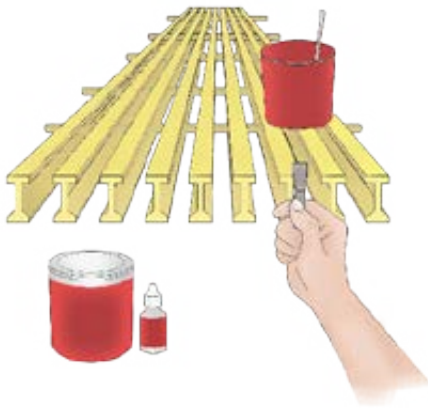

Follow the detailed mixing instructions on the container and never mix the entire container at once



EX-Series® Professional Diamond Blades	
	Angle Grinder
	4" (100mm - F-B-CD(100))
	5" (125mm - F-B-CD(125))
	Circular Saw / Angle Grinder
	7" (185mm - F-B-CD(185))
9" (228mm - F-B-CD(228))	

100mm Diamond T-Shank Jigsaw Blades	
	EX-Series® 100mm Diamond T-Shank Jigsaw Blades
	Code UOM: F-B-JS (100) Unit/Each

EX-Series® Sealer Kits	
	EX-Series® Polyester Sealer Kit, 500 g
	Code UOM: F-EXSK5001 Unit/Each
	EX-Series® Vinyl Ester Sealer Kit, 500 g
	Code UOM: F-EXSK500V Unit/Each
Ideal for sealing exposed fibres after any field cutting. These kits, which includes resin (standard 500 g) and catalyst (standard 15 ml), are available in polyester and vinyl ester.	

Disposable Application Brushes	
	EX-Series® Disposable Application Brushes
	Code UOM: F-EXDAB/12.7 Unit/Each
	Code UOM: F-EXDAB/25 Unit/Each

Premium Valve Respirator	
	Ex-Series® Premium Respirator
	Code UOM: F-EXPRWV Unit/Each

Drafting Information & Manufacturing Tolerances



Save on detailed drafting

When providing Treadwell with grating drawings, please ensure that only the outline of the actual grating is supplied along with all penetrations and cut-outs are displayed.

Treadwell will recommend the most economical breakdown of panels to suit your floor layout — this is because our forte in FRP products means that we stock more standard size panels. Save yourself the cost and let us take the pain out of it for you.

Treadwell utilises up to date CAD technology to create panel details and erection marking plans. Further, we can then have these drawings sent via email, fax, post or courier to any location for speedy approval or mark-up — a service many of our clients agree saves a lot of time and hassle!

All we need from you	What we will provide you with

Panels	Size (mm)	Length (mm)	Width (mm)	Thickness (mm)
	920 X 3055	± 3	± 3	± 1.5
	1220 X 3660 or larger	± L / 1000	± 3	± 1.5
Stairtreads	Size (mm)	Width (mm)	Depth (mm)	Thickness (mm)
	All sizes	± 3	± 3	± 1.5

Embedment Angle

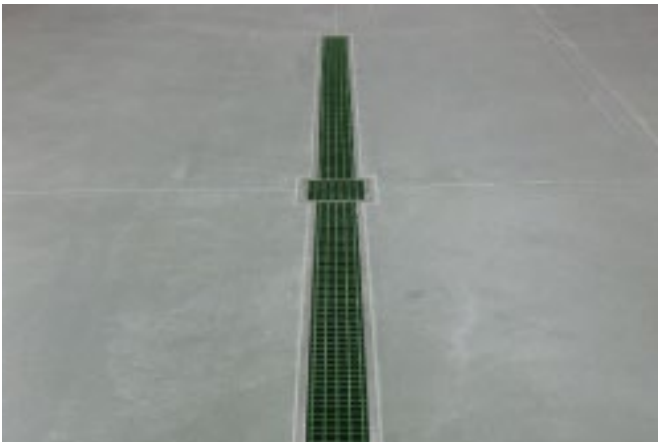

The Treadwell ArchitEX™ FRP Embedment Angle provides a very sturdy base for bearing bars and has a built-in continuous angle that locks into concrete, eliminating the need for individual anchors. The FRP embedment angle is engineered using a surfacing veil and fire retardant vinyl ester resin system.

This unique combination produces superior strength, stiffness, wear protection and long-term corrosion resistance required for longevity in industrial applications. The FRP embedment angle is suitable for use with both GratEX®, MoultrEX® and GridEX® products and is typically available in grey 3 m or 6 m lengths.

Profile	Code	Depth	Width	Weight
25 mm	F-[E]P-EA25	25 mm	38 mm	1.34 kg/m
38 mm	F-[E]P-EA38	38 mm	38 mm	1.52 kg/m
50 mm	F-[E]P-EA50	50 mm	38 mm	1.64 kg/m
100 mm	F-[E]P-EA100	100 mm	100 mm	2.71 kg/m

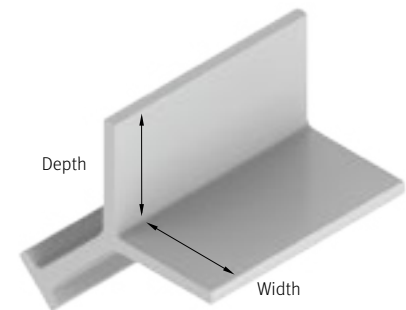

Safety Ramp



Treadwell's lightweight safety ramps can be adapted to any application. Flexible and sturdy enough to take even the heaviest of weights, they are resistant to fire, chemicals and corrosion. Being anti-slip in nature, FRP safety ramps are an extremely safe surface for your ramps in all types of weather.

Efficient and cost effective alternative to stainless or galvanised steel angles, these safety ramps can be readily installed onto domestic walkways, providing effective both pedestrian and wheel access.

Profile	Code	Depth	Width
25 mm	F-MG25(38/38)S-IYG*-RMP	120 mm	3660 mm
32 mm	F-MG32(38/38)S-IYG*-RMP	120h mm	3660 mm
38mm	F-MG38(38/38)S-IYG*-RMP	120 mm	3660 mm
50 mm	F-MG50(38/38)S-IYG*-RMP	158 mm	3660 mm

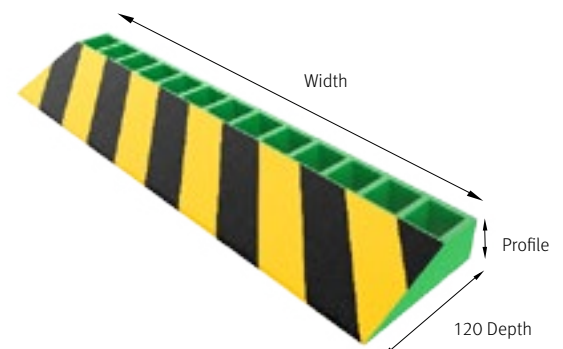

*Please note that the resin composition and colouration are customisable according to specifications. Please speak to us about the many options available to suit your needs.

StormChief®

StormChief®

Treadwell developed the StormChief® fastening system to provide a solution for fastening down grating products in environments that experience high wave action and subsequently require a fastening system that is designed to withstand wave zone loadings.

Wave action exerts extreme forces on grating, sometimes causing panels to be wrenched off substructures. This damage affects large industrial offshore structures such as oil and gas drilling platforms, dockside walkways or decks, and marine based recreational public infrastructure.

StormChief® Wave Zone Grating Fasteners save organisations large expenses in downtime due to access complications and restrictions and reinstallation costs. Additionally, the systems provide time saving installation methods such as the StormChief® Hybrid System which eliminates the necessity for access to the underside of the substructure.



StormChiefDISC®



Plan View

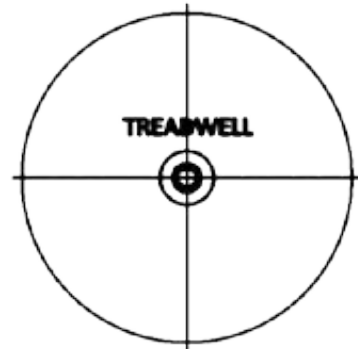

Elevation View

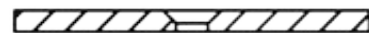

The StormChief DISC® is an extremely robust and secure grating fastening system intended for use in areas that experience high wave zone loadings. The DISC is designed to be used when the width of a walkway or deck area exceeds 1200mm or requires securing in situations where the application of the CLAW system is impractical. The DISC is recessed to ensure safe and secure pathway for all types of traffic accessing the area. This system is compatible with the H-Clip fastener and the StormChief® Hybrid System.

StormChief CLAW®

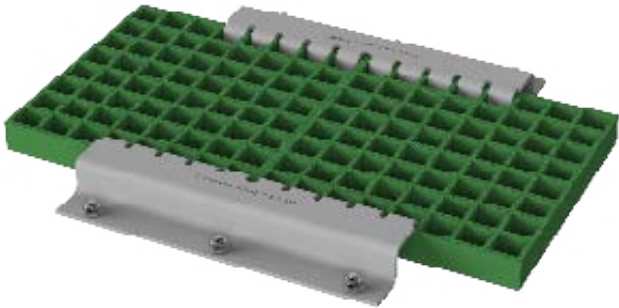

Elevation View



Plan View

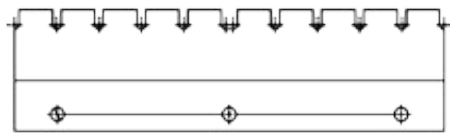

The StormChief CLAW® is a heavy duty 316 Stainless Steel grating fixing bracket that is designed to meet and exceed specifications for wave zone loadings. With integrated fingers that protrude into the grating aperture, the StormChief CLAW® provides secure fastening in even the harshest of coastal conditions. Used exclusively in conjunction with the StormChief® Hybrid System, it ensures simple, strong and rapid installation.

StormChief CLAMP®

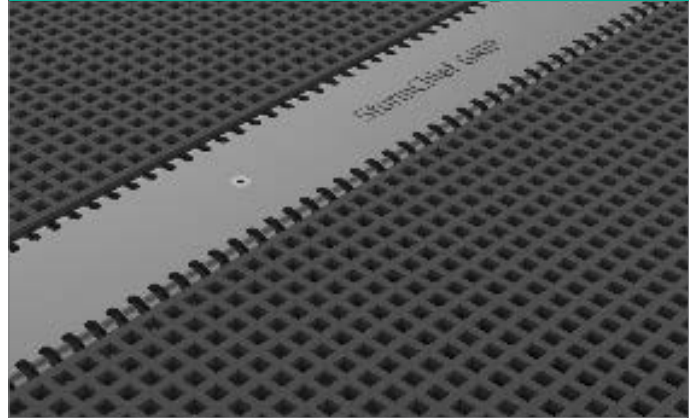

Elevation View



Plan View



The StormChief CLAMP® is a rugged stainless steel clamping bracket that is designed to meet and exceed the requirements of extreme wave zone loadings. The StormChief CLAMP® is a unique clamping system designed by Treadwell to seamlessly join two sheets of grating along one edge. This clip is easily recessed into the grating to ensure minimal trip hazard, making it ideal for public access areas that are subject to harsh coastal conditions.

StormChief® H-Clip Combination



StormChief® Recess Tool



Access Hatches, Handles & Hinge Systems

Access Hatches, Handles & Hinge Systems

Treadwell can custom design any type of cover or hatch using GratEX® Solid Surface Mesh and can simply and effectively make these lockable, removable and even hinged through the use of standard and custom ancillary products such as handles, hinges, frames and cam locks.

If you should have a unique application, please don't hesitate to contact us – there is a good chance we've encountered something similar in the past.

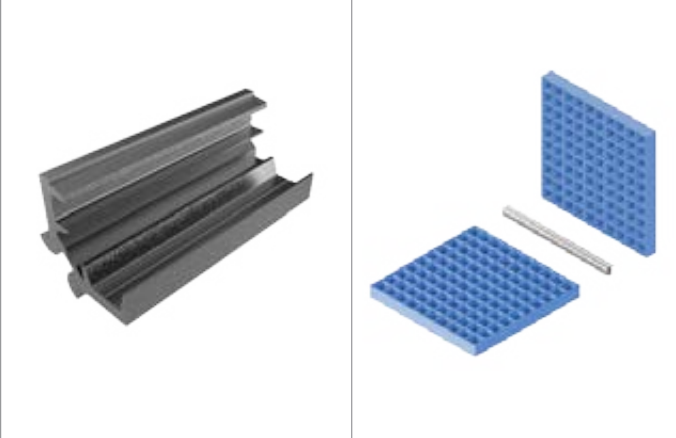
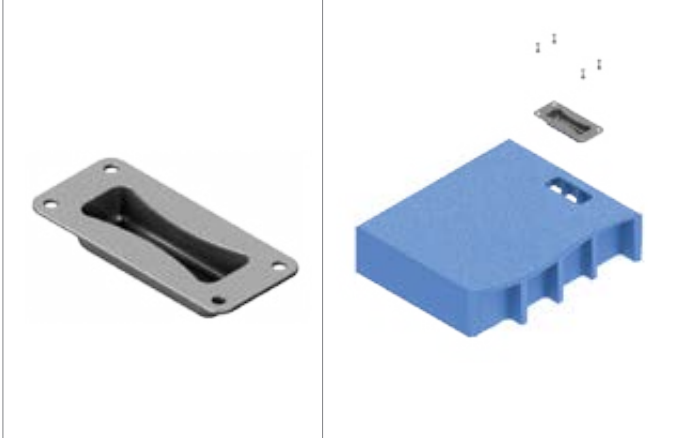
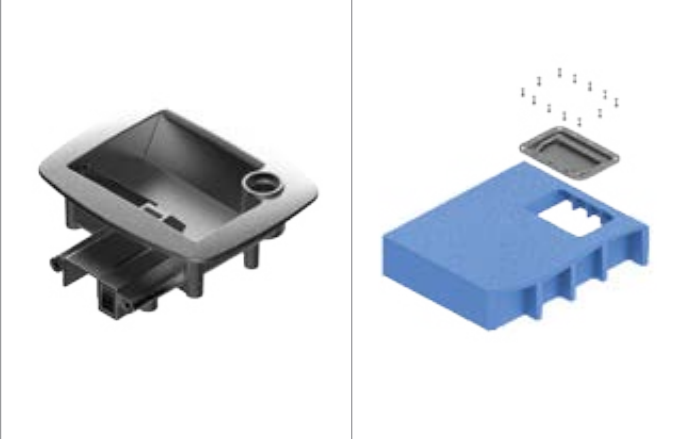
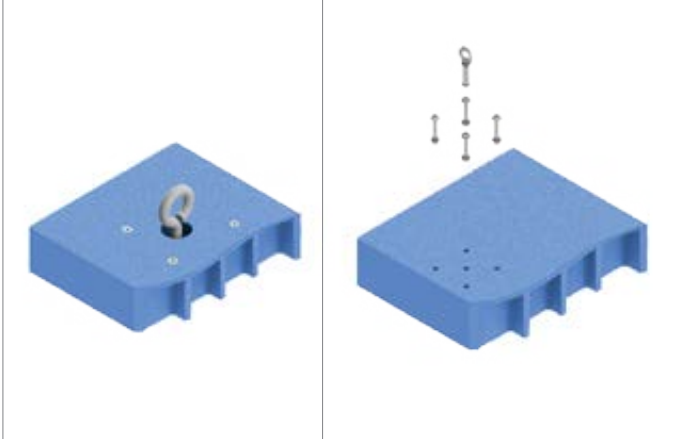
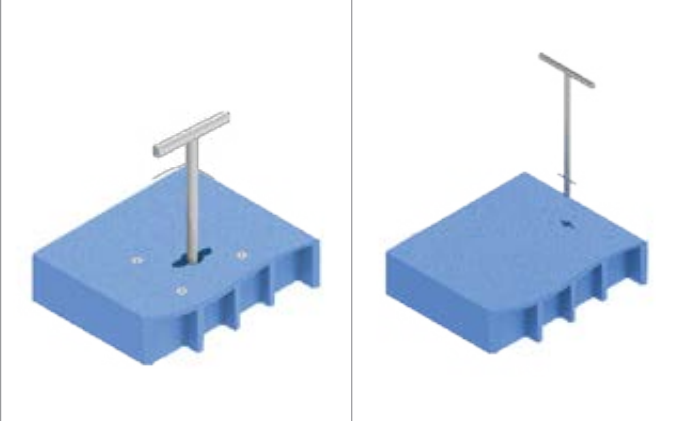
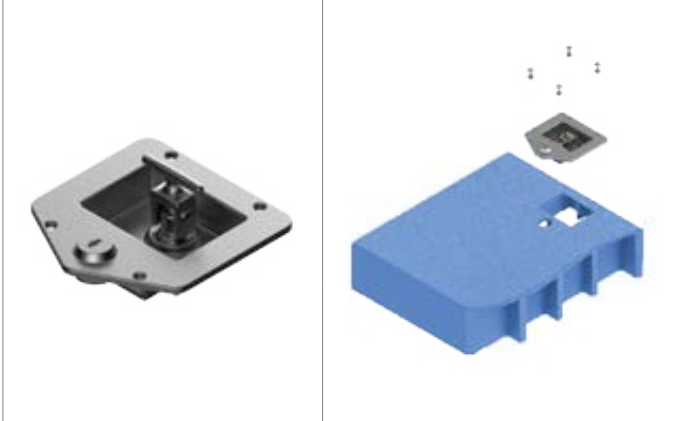
EX-Series® Non-Metallic Hinge 		EX-Series® Non-Metallic Recessed Handle 	
EX-Series® Spring Loaded Handle 		EX-Series® Eyelet Lift Kit 	
EX-Series® T-Bar Handle/Keyhole Lift Kit 		EX-Series® Lockable Handle 	

Elevated Support Systems

GratEX® Adjustable FRP Elevated Floor System		GratEX® FRP Elevated Floor System		
	GratEX® Adjustable FRP Elevated Floor System		GratEX® FRP Elevated Floor System	
	Code	MG-AEFS	Code	MG-EFS
	UOM	Unit/Each	UOM	Unit/Each
<p>This adjustable pedestal, constructed completely from FRP, is designed specifically for GratEX®. It provides excellent support for elevated flooring and has a long-standing history of outstanding performance in corrosive applications. Pedestals are available in polyester and vinylester resin systems. Standard colours are grey and black.</p>		<p>This fixed pedestal, also constructed from FRP, is designed for the support of elevated walkways and access-ways in dosing rooms and other areas where items on floors make access difficult. Pedestals are available in polyester and vinyl ester resin systems. Standard colours are grey and yellow.</p>		

Colossus

This unique range of non-metallic adjustable crew-jack elevated flooring pedestals offer uninterrupted adjustability and can support loads of more than 1,000 kg per pedestal. They can be adjusted to compensate up to 5% pitch, or compensate for locally uneven sub-bases up to the same amount. Once pedestals are at the required height (uninterruptedly adjustable between 17mm – 1070mm), their position is fixed with unique lockable keys.

INCREDIBLE SLOPE CORRECTION (UP TO 5%!)

Designed to adapt to any environment, the incredibly flexible slope correction feature, which is integrated on the heads of larger pedestals and supplied separately for the smaller ones, makes for extremely simplistic and quick installation of false floors.

UNIQUE HEIGHT LOCKING SYSTEM

Specifically developed to lock the pedestal at the required height, this feature ensures no subsequent rotational movement caused by traffic or vibration will destroy the integrity of your false floor over time.

PITCH ALTERATION BAND

This unique feature which is 115mm in diameter allows for the screw pitch of the pedestal to be reversed if required, making your job of levelling a false floor installation a cinch!

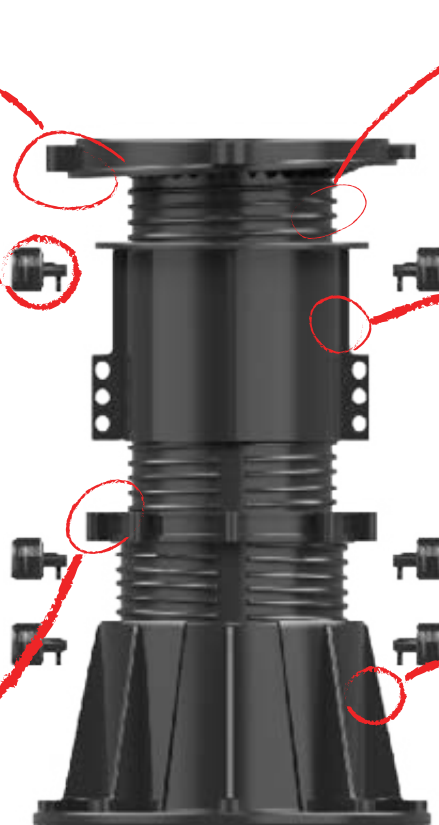

EXCELLENT SURFACE SUPPORT

With a surface area of 175cm² and a diameter of 150mm, the head of the pedestal is screwed directly onto the base, or on to the coupler. And, what's more, the head, with a diameter of 150mm, can be fitted with various components to support different surfaces.

EXTENSION COUPLERS AVAILABLE

Couplers are able to be used whenever the height of the pedestal exceeds 175mm. Two integrated tabs on either side allow for mechanical fixing or cross bracing, guaranteeing enhanced stability when the height exceeds 600mm.

STOUT & STURDY BASE

The base can be simply positioned or fixed to any substrate. It has fixing holes for screw or bolts. The head, couplers and bases have safety 'stop' pins to prevent over extension. The base has a surface area of 314 cm² and a diameter of 200mm.

Elevated Support Systems

<p>F-PD (17)</p> <p>17mm</p> 	<p>F-PD (28)</p> <p>28mm</p> 	<p>F-PD (25-36)</p> <p>25-36mm</p> 	<p>F-PD (35-53)</p> <p>35-53mm</p> 	<p>F-PD (50-78)</p> <p>50-78mm</p> 
<p>F-PD (75-108)</p> <p>75-108mm</p> 	<p>F-PD (100-175)</p> <p>100-175mm</p> 	<p>F-PD (175-285)</p> <p>175-285mm</p> 	<p>F-PD (285-400)</p> <p>285-400mm</p> 	<p>F-PD (355-515)</p> <p>355-515mm</p> 
<p>F-PD (465-625)</p> <p>465-625mm</p> 	<p>F-PD (545-740)</p> <p>545-740mm</p> 	<p>F-PD (645-850)</p> <p>645-850mm</p> 	<p>F-PD (720-960)</p> <p>720-960mm</p> 	<p>F-PD (830-1070)</p> <p>830-1070mm</p> 

Appendix 1; Load Data Tables

Point Load

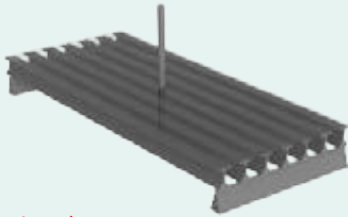

Uniform Load

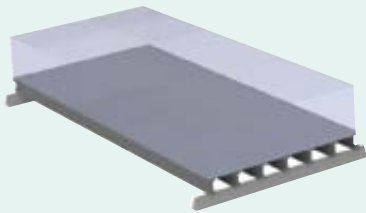

1. The following tables were developed in accordance with the test method developed by the Fibreglass Grating Manufacturers Council (FGMC) of the American Composites Manufacturers Association (ACMA) for the Fibreglass Grating Standard.
2. The designer should not exceed MAXIMUM RECOMMENDED load at any time. MAXIMUM LOAD represents a 4:1 factor of safety on ULTIMATE CAPACITY. ULTIMATE CAPACITY represents MAX LOAD observed at initial fracture.
3. Walking loads for maintenance traffic are typically a live load of 50 PSF. Deflections for worker comfort are typically limited to 0.375" (3/8") or SPAN divided by 120 under full live load. For a firmer feel under full live load or a line load 250 lbs/ft to width, limit deflections to 0.25" (1/4") or SPAN divided by 200.
4. The loads represented are for STATIC LOAD CONDITIONS at ambient temperature. Deflections for impact loads or dynamic loads will MULTIPLY the deflections shown by 2. Long term loads will result in added deflection due to creep in the material and will require higher factors of safety to ensure acceptable performance.
5. Deflections are limited to 0.5" (1/2") as recommended by the Fibreglass Grating Manufacturers Council of the American Composites Manufacturers Association.

Appendix 2; Chemical Resistance Guide

Information contained in this guide is based on data collected from several years of actual industrial applications. Recommendations are based on conservative evaluations of the changes which occur in certain properties of replicate laminates after exposures of one year or longer, both in the laboratory and the field.

Temperatures are neither the minimum nor the maximum but represent standard test conditions (Room Temperature & 70°C). The products may be suitable at higher temperatures but individual

test data should be required to establish such suitability. Contact Treadwell for any special applications that you may have.

The recommendations (• : resistant: –: not resistant) contained in this specification sheet are made without guarantee or representation as to results. We suggest that you evaluate these recommendations and suggestions in your own laboratory or actual field trial prior to use. Our responsibility for claims arising from breach of warranty, negligence, or otherwise **is limited to the purchase price of the material.**

Chemical	I-Series		V-Series	
	Room Temp	70°C	Room Temp	70°C
Acetaldehyde	–	–	–	–
Acetic Acid 0-25%	•	•	•	•
Acetic Acid 25-50%	•	–	•	•
Acetic Anhydride	–	–	–	–
Acetone	–	–	–	–
Acrylonitrile	–	–	–	–
Alcohol, Butyl	–	–	•	–
Alcohol, Ethyl 10%	–	–	•	66
Alcohol, Ethyl 100%	–	–	•	–
Alcohol, Isopropyl 10%	–	–	•	66
Alcohol, Isopropyl 100%	–	–	•	–
Alcohol, Methyl 10%	–	–	•	66
Alcohol, Methyl 100%	–	–	–	–
Alcohol, Methyl Isobutyl	–	–	•	66
Alcohol, Secondary Butyl	–	–	•	66
Alum	•	•	•	•
Aluminium Chloride	•	•	•	•
Aluminium Hydroxide	•	–	•	49
Aluminium Nitrate	•	•	•	•

Chemical	I-Series		V-Series	
	Room Temp	70°C	Room Temp	70°C
Aluminium Potassium Sulfate	•	•	•	•
Ammonia, Aqueous 0-10%	–	–	•	38
Ammonia, Gas	–	–	•	38
Ammonium Bicarbonate	•	–	•	49
Ammonium Bisulfite	–	–	•	49
Ammonium Carbonate	–	–	•	49
Ammonium Citrate	•	–	•	49
Ammonium Fluoride	–	–	•	49
Ammonium Hydroxide 5%	•	–	•	49
Ammonium Hydroxide 10%	•	–	•	49
Ammonium Hydroxide 20%	–	–	•	49
Ammonium Nitrate	•	•	•	49
Ammonium Persulfate	–	–	•	49
Ammonium Phosphate	–	–	•	49
Ammonium Sulfate	•	•	•	•
Arsenious Sulfate	•	–	•	•
O-Benzoyl Benzoic Acid	–	–	•	•
Barium Carbonate	•	–	•	•
Barium Chloride	•	–	•	•

Appendix 2; Chemical Resistance Guide

Chemical	I-Series		V-Series	
	Room Temp	70°C	Room Temp	70°C
Barium Hydroxide	-	-	•	49
Barium Sulfate	•	•	•	•
Barium Sulfide	-	-	•	•
Beer	•	-	•	49
Benzene	-	-	-	-
5% Benzene in Kerosene	•	-	•	•
Benzene Sulfonic Acid	•	•	•	•
Benzoic Acid	•	-	•	•
Benzyl Alcohol	-	-	•	-
Benzyl Chloride	-	-	-	-
Brass Plating Solution:				
- 3% Copper Cyanide	-	-	•	•
- 6% Sodium Cyanide	-	-	•	•
- 1% Zinc Cyanide	-	-	•	•
- 3% Sodium Carbonate	-	-	•	•
Butyl Acetate	-	-	-	-
Butyric Acid 0-50%	•	-	•	•
Butylene Glycol	•	•	•	•
Cadmium Chloride	•	-	•	•
Cadmium Cyanide Plating Soln:				
- 3% Cadmium Oxide	-	-	•	49
- 6% Sodium Cyanide	-	-	•	49
- 1% Caustic Soda	-	-	•	49
Calcium Bisulfate	•	•	•	•
Calcium Carbonate	•	-	•	•
Calcium Chlorate	•	•	•	•
Calcium Chloride	•	•	•	•
Calcium Hydroxide	•	-	•	49
Calcium Hypochlorite	•	-	•	49
Calcium Nitrate	•	•	•	•
Calcium Sulfate	•	•	•	•
Calcium Sulfite	•	•	•	•
Caprylic Acid	•	-	•	•
Carbon Dioxide	•	•	•	•
Carbon Disulfide	-	-	-	-
Carbon Monoxide	•	•	•	•
Carbon Tetrachloride	-	-	•	38
Carbon Acid	•	-	•	•
Castor Oil	•	•	•	•
Carbon Methyl Cellulose	-	-	•	49
Chlorinated Wax	-	-	•	•
Chlorine Doixide/Air	•	-	•	•
Chlorine Dioxide, Wet Gas	-	-	•	•
Chlorine, Dry Gas	-	-	•	•
Chlorine, Wet Gas	-	-	•	•
Chlorine, Liquid	-	-	-	-

Chemical	I-Series		V-Series	
	Room Temp	70°C	Room Temp	70°C
Chlorine, Water	-	-	•	•
Chloroacetic Acid 0-50%	-	-	•	38
Chlorobenzene	-	-	-	-
Chloroform	-	-	-	-
Chlorosulfonic Acid	-	-	-	-
Chromic Acid 20%	-	-	•	49
Chromic Acid 30%	-	-	-	-
Chromium Sulfate	•	•	•	•
Citric Acid	•	•	•	•
Coconut Oil	•	-	•	•
Copper Chloride	•	•	•	•
Copper Cyanide	-	-	•	•
Copper Fluoride	-	-	•	•
Copper Nitrate	•	•	•	•
Copper Plating Solution:				
- Copper Cyanide	-	-	•	•
- 10.5% Copper	-	-	•	•
- 4% Copper Cyanide	-	-	•	•
- 6% Rochelle Salts	-	-	•	•
Copper Brite Plating:				
- Caustic Cyanide	-	-	•	38
Copper Plating Solution:				
- 45% Copper Fluoroborate	-	-	•	•
- 19% Copper Sulfate	-	-	•	•
- 8% Sulfuric Acid	-	-	•	•
Copper Matte Dipping Bath:				
- 30% Ferric Chloride	-	-	•	•
- 19% Hydrochloric	-	-	•	•
Copper Pickling Bath:				
- 10% Ferric Sulfate	-	-	•	•
- 10% Sulfuric Acid	-	-	•	•
Copper Sulfate	•	•	•	•
Corn Oil	•	-	•	•
Corn Starch-Slurry	•	-	•	•
Corn Sugar	•	-	•	•
Cottonseed Oil	•	-	•	•
Crude Oil, Sour	•	-	•	•
Crude Oil, Sweet	•	-	•	•
Cyclohexane	•	-	•	49
Detergents, Sulfonated	•	-	•	•
Di-Ammonium Phosphate	•	-	•	•
Dibromophenol	-	-	-	-
Dibutyl Ether	-	-	•	49
Dichloro Benzene	-	-	-	-
Dichloroethylene	-	-	-	-
Diesel Fuel	•	-	•	•

Appendix 2; Chemical Resistance Guide

Chemical	I-Series		V-Series	
	Room Temp	70°C	Room Temp	70°C
Diethylene Glycol	•	–	•	•
Dimethyl Phthalate	–	–	•	•
Diethyl Phthalate	–	–	•	•
Diprophylene Glycol	•	–	•	•
Dodecyl Alcohol	–	–	•	•
Esters, Fatty Acids	•	•	•	•
Ethyl Acetate	–	–	–	–
Ethyl Benzene	–	–	–	–
Ethyl Ether	–	–	–	–
Ethylene Glycol	•	•	•	•
Ethylene Dichloride	–	–	–	–
Fatty Acids	•	•	•	•
Ferric Chloride	•	•	•	•
Ferric Nitrate	•	•	•	•
Ferric Sulfate	•	•	•	•
Ferrous Chloride	•	•	•	•
Ferrous Nitrate	•	•	•	•
Ferrous Sulfate	•	•	•	•
8-8-8 Fertiliser	•	–	•	49
Fertiliser:				
– Urea Ammonium Nitrate	–	–	•	49
Fuel Gas	–	–	•	•
Fluoboric Acid	–	–	•	49
Fluosilicic Acid 0-20%	–	–	•	•
Formaldehyde	•	–	•	•
Formic Acid	•	–	•	•
Fuel Oil	•	–	•	•
Gas Natural	•	–	•	•
Gasoline, Auto	•	–	•	•
Gasoline, Aviation	•	–	•	•
Gasoline, Ethyl	•	–	•	•
Gluconic Acid	•	–	•	•
Gasoline, Sour	•	–	•	•
Glucose	•	•	•	•
Glycerine	•	•	•	•
Glycol, Ethylene	•	•	•	•
Glycol, Propylene	•	•	•	•
Glycolic Acid	•	–	•	•
Gold Plating Solution:				
– 63% Potassium Ferrocyanide	–	–	•	•
– 2% Potassium Gold Cyanide	–	–	•	•
– 8% Sodium Cyanide	–	–	•	•
Heptane	•	–	•	•
Hexane	•	–	•	•
Hexylene Glycol	•	•	•	•
Hydraulic Fluid	•	–	•	•

Chemical	I-Series		V-Series	
	Room Temp	70°C	Room Temp	70°C
Hydrobromic Acid 0-25%	•	–	•	•
Hydrochloric Acid 0-37%	•	–	•	•
Hydrocyanic Acid	•	–	•	•
Hydrofluoric Acid 10%	–	–	•	–
Hydrofluosilicic Acid, 10%	–	–	•	•
Hydrogen Bromide, Wet Gas	–	–	•	•
Hydrogen Chloride, Dry Gas	–	–	•	•
Hydrogen Chloride, Wet Gas	–	–	•	•
Hydrogen Peroxide	–	–	•	49
Hydrogen Sulfide, Dry	•	–	•	•
Hydrogen Sulfide, Aqueous	•	–	–	•
Hydrogen Fluoride, Vapour	–	–	•	•
Hydrosulfite Bleach	–	–	•	49
Hydrochloric Acid 0-10%				
Iron Plating Solution:				
– 45% FeCl: 15% CaCl	–	–	•	•
– 20% FeCl: 11% (Nh4)2 So4	–	–	•	•
Iron And Steel Claeaning Bath:				
–9% Hydrochloric: 23% Sulfuric	–	–	•	•
Isopropyl Amine	–	–	•	38
Isopropyl Palmitate	•	•	•	•
Jet Fuel	•	–	•	•
Kerosene	•	–	•	•
Lactic Acid	•	–	•	•
Lauroryl Chloride	–	–	•	•
Lauric Acid	•	–	•	•
Lead Acetate	•	–	•	•
Lead Chloride	•	–	•	•
Lead Nitrate	•	–	•	•
Lead Plating Solution:				
–.8% Fluoboric, 0.4% Boric Acid	–	–	•	•
Levulinic Acid	•	–	•	•
Linseed Oil	•	•	•	•
Lithium Bromide	•	•	•	•
Lithium Sulfate	•	•	•	•
Magnesium Bisulfite	•	–	•	•
Magnesium Carbonate	•	–	•	•
Magnesium Chloride	•	•	•	•
Magnesium Hydroxide	–	–	•	60
Magnesium Nitrate	•	–	•	•
Magnesium Sulfate	•	•	•	•
Maleic Acid	•	•	•	•
Mercuric Chloride	•	–	•	•
Mercurous Chloride	•	–	•	•
Methylene Chloride	–	–	–	–
Methyl Ethyl Ketone	–	–	–	–

Appendix 2; Chemical Resistance Guide

Chemical	I-Series		V-Series	
	Room Temp	70°C	Room Temp	70°C
Methyl Isobutyl Carbitol	-	-	-	-
Methanol (See Alcohol)	•	-	•	•
Methyl Isobutyl Ketone	-	-	-	-
Methyl Styrene	-	-	-	-
Mineral Oils	•	•	•	•
Molybdenum Disulfide	•	-	•	•
Monochloro Acetic Acid	-	-	-	-
Monoethanolamine	-	-	-	-
Motor Oil	•	•	•	•
Myristic Acid	-	-	•	•
Naptha	•	•	•	•
Napthalene	•	-	•	•
Nickel Chloride	•	•	•	•
Nickel Nitrate	•	•	•	•
Nickel Plating:				
- 8% Lead, 0.8% Flouboric Acid	-	-	•	•
- 0.4% Boric Acid	-	-	•	•
Nickel Plating:				
- 11% Nickel Sulfate	•	-	•	•
- 2% Nickel Chloride	•	-	•	•
- 1% Boric Acid	•	-	•	•
Nickel Plating:				
- 44% Nickel Sulfate	•	-	•	•
- 4% Ammonium Chloride	•	-	•	•
- 4% Boric Acid	•	-	•	•
Nickel Sulfate	•	•	•	•
Nitric Acid 0-5%	•	•	•	•
Nitric Acid 20%	-	-	•	49
Nitric Acid Fumes	-	-	-	-
Nibrobenzene	-	-	-	-
Octanoci Acid	•	-	•	•
Oil, Sour Crude	•	•	•	•
Oil, Sweet Crude	•	•	•	•
Oleic Acid	•	•	•	•
Oleum (Fuming Sulfuric)	-	-	-	-
Olive Oil	•	•	•	•
Oxalic Acid	•	•	•	•
Peroxide Bleach:				
- 25% Peroxide 95%	•	•	•	•
- 0.025% Epsom Salts	•	•	•	•
- 5% Sodium Silicate 42.Be	•	•	•	•
- 1.4% Sulfuric Acid 66.Be	•	•	•	•
Phenol	-	-	-	-
Phenol Sulfonic Acid	-	-	-	-
Phosphoric Acid	•	•	•	•
Phosphoric Acid Fumes	•	•	•	•

Chemical	I-Series		V-Series	
	Room Temp	70°C	Room Temp	70°C
Phosphorous Pentoxide	•	•	•	•
Phosphorous Trichloride	-	-	-	-
Phthalic Acid	•	•	•	•
Pickling Acids (Sulfuric & Hydrochloric)	•	•	•	•
Picric Acid, Alcoholic				
Polyvinyl Acetate Latex	•	-	•	•
Polyvinyl Alcohol	•	-	•	38
Polyvinyl Chloride Latex W/35 (Parts Dop)	-	-	•	49
Potassium Aluminium Sulfate	•	•	•	•
Potassium Bicarbonate	•	-	•	60
Potassium Bromide	•	-	•	38
Potassium Carbonate	•	-	•	60
Potassium Chloride	•	•	•	•
Potassium Dichromate	•	-	•	60
Potassium Ferricyanide	•	•	•	•
Potassium Ferrocyanide	•	•	•	•
Potassium Hydroxide	-	-	•	66
Potassium Nitrate	•	•	•	•
Potassium Permanganate	•	-	•	60
Potassium Persulfate	•	-	•	•
Potassium Sulfate	•	•	•	•
Propionic Acid 1-50%	-	-	•	49
Propionic Acid 50-100%	-	-	-	-
Propylene Glycol	•	•	•	•
Pulp Paper Mill Effluent	•	-	•	•
Pyridine	-	-	-	-
Salicylic Acid	-	-	•	60
Sebacic Acid	-	-	•	•
Selenious Acid	-	-	•	•
Silver Nitrate	•	•	•	•
Silver Plating Solution:				
- 44% Silver Cyanide	-	-	•	•
- 7% Potassium Cyanide	-	-	•	•
- 5% Sodium Cyanide	-	-	•	•
- 2% Potassium Carbonate	-	-	•	•
Soaps	•	-	•	•
Sodium Acetate	•	-	•	•
Sodium Benzoate	•	-	•	•
Sodium Bicarbonate	•	•	•	•
Sodium Bifluoride	•	-	•	49
Sodium Bisulfate	•	•	•	•
Sodium Bisulfite	•	•	•	•
Sodium Bromate	•	•	•	60
Sodium Bromide	•	•	•	•
Sodium Carbonate 0-25%	•	-	•	•

Appendix 2; Chemical Resistance Guide

Chemical	I-Series		V-Series	
	Room Temp	70°C	Room Temp	70°C
Sodium Chlorate	•	–	•	•
Sodium Chloride	•	•	•	•
Sodium Chlorite	•	–	•	•
Sodium Chromite	•	•	•	•
Sodium Cyanide	•	–	•	•
Sodium Dichromate	•	•	•	•
Sodium Di-Phosphate	•	•	•	•
Sodium Ferricyanide	•	•	•	•
Sodium Fluoride	•	–	•	49
Sodium Fluoro Silicate	–	–	•	49
Sodium Hexametaphosphates	–	–	•	38
Sodium Hydroxide 0-5%	–	–	•	66
Sodium Hydroxide 5-25%	–	–	•	66
Sodium Hydroxide 50%	–	–	•	66
Sodium Hydrosulfide	•	–	•	•
Sodium Hypochlorite	•	–	•	66
Sodium Lauryl Sulfate	•	•	•	•
Sodium Mono-Phosphate	•	•	•	•
Sodium Nitrate	•	•	•	•
Sodium Silicate	•	–	•	•
Sodium Sulfate	•	•	•	•
Sodium Sulfide	•	–	•	•
Sodium Sulfite	•	–	•	•
Sodium Tetra Borate	•	•	•	•
Sodium Thiocyanate	–	–	•	•
Sodium Thiosulfate	•	–	•	•
Sodium Tripolyphosphate	•	–	•	•
Sodium Xylene Sulfonate	•	–	•	•
Sodium Solutions	•	–	•	•
Sodium Crude Oil	•	•	•	•
Soya Oil	•	•	•	•
Stannic Chloride	•	•	•	•
Stannous Chloride	•	•	•	•
Stearic Acid	•	•	•	•
Styrene	–	–	–	–
Sugar, Beet And Cane Liquor	•	–	•	•
Sugar, Sucrose	•	•	•	•
Sulfamic Acid	•	–	•	•
Sulfanilic Acid	•	–	•	•
Sulfated Detergents	•	–	•	•
Sulfur Dioxide, Dry Or Wet	–	–	•	•
Sulfur Trioxide/Air	–	–	•	•
Sulfuric Acid 0-30%	•	•	•	•
Sulfuric Acid 30-50%	–	–	•	•
Sulfuric Acid 50-70%	–	–	•	49
Sulfurous Acid	–	–	•	38

Chemical	I-Series		V-Series	
	Room Temp	70°C	Room Temp	70°C
Superphosphoric Acid (76% P2 O5)	•	–	•	•
Tall Oil	•	–	•	60
Tannic Acid	•	–	•	66
Tartaric Acid	•	•	•	•
Thionyl Chloride	–	–	–	–
Tin Plating:				
– 18% Stannous Fluoroborate	–	–	•	•
– 7% Tin	–	–	•	•
– 9% Fluoroboric Acid	–	–	•	•
– 2% Boric Acid	–	–	•	•
Toluene	–	–	–	–
Toluene Sulfonic Acid	–	–	•	•
Transformer Oils:				
– Mineral Oil Types	•	•	•	•
– Chloro-Phenyl Types)	•	•	•	•
Trichlor Acetic Acid	•	–	•	•
Trichlorethylene	–	–	–	–
Trichloropenol	–	–	–	–
Tricresyl Phosphate	–	–	•	49
Tridecylbenzene Sulfonate	•	–	•	•
Trisodium Phosphate	•	–	•	•
Turpentine	–	–	•	38
Urea	–	–	•	38
Vegetable Oils	•	•	•	•
Vinegar	•	•	•	•
Vinyl Acetate	–	–	–	–
Water:				
– Deionised				
– Demineralised	•	•	•	•
– Distilled	•	•	•	•
– Fresh	•	•	•	•
– Salt	•	•	•	•
– Sea	•	•	•	•
White Liquor (Pulp Mill)	•	–	•	•
Xylene	–	–	–	–
Zinc Chlorate	•	•	•	•
Zinc Nitrate	•	•	•	•
Zinc Plating Solution:				
– 9% Zinc Cyanide	–	–	•	49
– 4% Sodium Cyanide	–	–	•	49
–9% Sodium Hydroxide	–	–	•	49
Zinc Plating Solution:				
– (49% Zinc Fluoroborate	•	–	•	•
– 5% Ammonium Chloride	•	–	•	•
– 6% Ammonium Fluoroborate	•	–	•	•
Zinc Sulfate	•	•	•	•

Appendix 3: GratEX® Ordering Codes

F-MG38(38/38)S-IGG/1			
Code	Description		
F-MG	Fibreglass Moulded Grating - GratEX®		
38	Mesh Thickness		
	13	13mm	30 30mm
	14	14mm	35 35mm
	15	15mm	38 38mm
	20	20mm	50 50mm
	22	22mm	53 53mm
	23	23mm	55 55mm
	25	25mm	60 60mm
(38/38)	Mesh Aperture		
	(13/13) = 13mm x 13mm	(38/38) = 38mm x 38mm	
	(14/14) = 14mm x 14mm	(38/100) = 38mm x 100mm	
	(19/19) = 19mm x 19mm	(38/152) = 38mm x 152mm	
	(20/20) = 20mm x 20mm	(40/40) = 40mm x 40mm	
	(25/25) = 25mm x 25mm	(50/50) = 50mm x 50mm	
	(25/50) = 25mm x 50mm	(60/220) = 60mm x 220mm	
	(25/100) = 25mm x 100mm	(79/79) = 79mm x 79mm	
(25/152) = 25mm x 152mm	(83/83) = 83mm x 83mm		
S	Mesh Detail		
	S Standard Square	MM Micro Mesh	
	DS Diagonal Square	R Rectangular Mesh	
	HDS Heavy duty Square Mesh	HDR Heavy Duty Rectangular Mesh	
	M Mini Mesh	(3)F Solid Surface (3mm Flat) Mesh	
I	Resin Type		
	O = O Series		
	I = I Series		
	V = V Series		
G	Colour		
	G = Industrial Green	DG = Dark Grey	
	Y = Safety Yellow	CH = Charcoal	
G	LG = Light Grey	C = Custom	
	Surface Option		
	CG = Commercial Grade (Grit) Anti-Slip	MG = Marine Grade (Grit) Anti-Slip	
	G = Industrial Grade (Grit) Anti-Slip	CH = Chequer Plate	
1	Panel Size		
	1 = 1225mm x 3665mm		
	2 = 920mm x 3055mm		
	3 = Custom*		
Note: This section of coding is separated by a slash (/), it isn't required for custom jobs as GratEX® is available in a variety of size panels to suit applications.			

Appendix 4: MoultrEX® Ordering Codes

F-MPG38(38/100)R-IGG/1		
Code	Description	
F-MPG	Fibreglass Moultruded Grating - MoultrEX®	
38	Mesh Thickness	
	38	38mm
	50	50mm
(38/100)	Mesh Aperture	
	(25/100) = 25mm x 100mm	
	(38/100) = 38mm x 100mm	
R	Mesh Detail	
	R Rectangular Mesh	
I	Resin Type	
	O = O Series	
	I = I Series	
	V = V Series	
G	Colour	
	G = Industrial Green	
	Y = Safety Yellow	
	LG = Light Grey	
	DG = Dark Grey	
	CH = Charcoal	
	C = Custom	
G	Surface Option	
	CG = Commercial Grade (Grit) Anti-Slip	
	G = Industrial Grade (Grit) Anti-Slip	
	MG = Marine Grade (Grit) Anti-Slip	
	CH = Chequer Plate	
	P = Plain (Flat)	
1	Panel Size	
	1 = 1225mm x 3665mm	
	2 = 920mm x 3055mm	
	3 = Custom*	
	Note: This section of coding is separated by a slash (/), it isn't required for custom jobs as GratEX® is available in a variety of size panels to suit applications .	

Appendix 5: GridEX® Ordering Codes

F-PG38(15/15)B-VGG/1			
Code	Description		
F-PG	Fibreglass Pultruded Grating - GridEX®		
38	Mesh Thickness		
	25	25mm	52
			52mm
	39	39mm	67
		67mm	80
		80mm	
(15/15)	Mesh Aperture		
	(5.3/7.8) = 5.3mm x 7.8mm		(15/22.8) = 15mm x 22.8mm
	(7.8/5.3) = 7.8mm x 5.3mm		(15/23) = 15mm x 23mm
	(7.8/7.8) = 7.8mm x 7.8mm		(22/25) = 22mm x 25mm
	(7.8/12) = 7.8mm x 12mm		(25/5) = 22mm x 5mm
	(15/10) = 15mm x 10mm		(25/12.7) = 25mm x 12.7mm
	(15/15) = 15mm x 15mm		(40/9.6) = 40mm x 9.6mm
		(40/22.3) = 40mm x 22.3mm	
B	Mesh Detail		
	I I Type		
	T T Type		
	B B Type		
V	Resin Type		
	O = O Series		
	I = I Series		
	V = V Series		
G	Colour		
	G = Industrial Green		DG = Dark Grey
	Y = Safety Yellow		CH = Charcoal
	LG = Light Grey		C = Custom
G	Surface Option		
	CG = Commercial Grade (Grit) Anti-Slip		MG = Marine Grade (Grit) Anti-Slip
			CH = Chequer Plate
	G = Industrial Grade (Grit) Anti-Slip		P = Plain (Flat)
1	Panel Size		
	1 = 1225mm x 3665mm		
	2 = 920mm x 3055mm		
	3 = Custom*		
Note: This section of coding is separated by a slash (/), it isn't required for custom jobs as GratEX® is available in a variety of size panels to suit applications.			

Appendix 6a: GratEX® Fasteners Ordering Information

F-MG38(38/38)S-M316				
Code	Description			
F-MG	Fibreglass Moulded Grating - GratEX®			
38	Mesh Thickness			
	13	13mm	35	35mm
	14	14mm	38	38mm
	15	15mm	50	50mm
	20	20mm	53	53mm
	22	22mm	55	55mm
	23	23mm	60	60mm
	25	25mm	63	63mm
	30	30mm	~	Universal
(38/38)	Mesh Aperture			
	(13/13) = 13mm x 13mm		(38/38) = 38mm x 38mm	
	(14/14) = 14mm x 14mm		(38/100) = 38mm x 100mm	
	(19/19) = 19mm x 19mm		(38/152) = 38mm x 152mm	
	(20/20) = 20mm x 20mm		(40/40) = 40mm x 40mm	
	(25/25) = 25mm x 25mm		(50/50) = 50mm x 50mm	
	(25/50) = 25mm x 50mm		(60/220) = 60mm x 220mm	
	(25/100) = 25mm x 100mm		(79/79) = 79mm x 79mm	
	(25/152) = 25mm x 152mm		(83/83) = 83mm x 83mm	
	(-) Universal			
S	Mesh Detail			
	S Standard Square		MM Micro Mesh	
	DS Diagonal Square		R Rectangular Mesh	
	HDS Heavy duty Square Mesh		HDR Heavy Duty Rectangular Mesh	
	M Mini Mesh		F Solid Surface (Flat) Mesh	
	HDF Heavy Duty Solid Surface (Flat) Mesh			
M	Clip Type			
	M	M Clip	S	S Clip
	C	C Clip	J	J Clip
	L	L Clip	H	H Clip
	D	D Clip	G	G Clip
	E	E Clip	U	U Clip
	W	W Clip	V	V Clip
O	O Clip	T	T Clip	
316	Clip Material			
	304	304 Stainless Steel	2507	Super Duplex Stainless Steel
	316	316 Stainless Steel	ALU	Aluminium
	2205	Duplex Stainless Steel	HDG	Hot Dipped Galvanised

Appendix 6b: MoultrEX® Fasteners Ordering Information

F-MPG38(25/100)R-M316				
Code		Description		
F-MPG		Fibreglass Moultruded Grating - MoultrEX®		
38	Mesh Thickness			
	38	38	38mm	
	50	50	50mm	
	~	~	Universal	
(25/100)	Mesh Aperture			
	(25/100)	25	100	25mm x 100mm
	(38/100)	38	100	38mm x 100mm
	(~)	~	Universal	
R	Mesh Detail			
	R	Rectangular Mesh		
M	Clip Type			
	M	M	M Clip	
	J	J	J Clip	
	G	G	G Clip	
	U	U	U Clip	
	V	V	V Clip	
316	Clip Material			
	304	304 Stainless Steel	2507	Super Duplex Stainless Steel
	316	316 Stainless Steel	ALU	Aluminium
	2205	Duplex Stainless Steel	HDG	Hot Dipped Galvanised

Appendix 6c: GridEX® Fasteners Ordering Information

F-PG38(15/15)I-M316				
Code	Description			
F-PG	Fibreglass Pultruded Grating - GridEX®			
38	Mesh Thickness			
	25	25mm		
	38	39mm		
	50	50mm		
	64	64mm		
	76	76mm		
(15/15)	Mesh Aperture			
	(5.3/7.8) = 5.3mm x 7.8mm	(15/23) = 15mm x 23mm		
	(7.8/5.3) = 7.8mm x 5.3mm	(22/25) = 22mm x 25mm		
	(7.8/7.8) = 7.8mm x 7.8mm	(25/5) = 22mm x 5mm		
	(7.8/12) = 7.8mm x 12mm	(25/12.7) = 25mm x 12.7mm		
	(15/10) = 15mm x 10mm	(40/9.6) = 40mm x 9.6mm		
	(15/15) = 15mm x 15mm	(40/22.3) = 40mm x 22.3mm		
(15/22.8) = 15mm x 22.8mm	(~) Universal			
I	Mesh Detail			
	I	I Type		
	T	T Type		
	B	B Type		
M	Clip Type			
	M	M Clip		
	J	J Clip		
	G	G Clip		
	U	U Clip		
V	V Clip			
316	Clip Material			
	304	304 Stainless Steel	2507	Super Duplex Stainless Steel
	316	316 Stainless Steel	ALU	Aluminium
	2205	Duplex Stainless Steel	HDG	Hot Dipped Galvanised

Notes

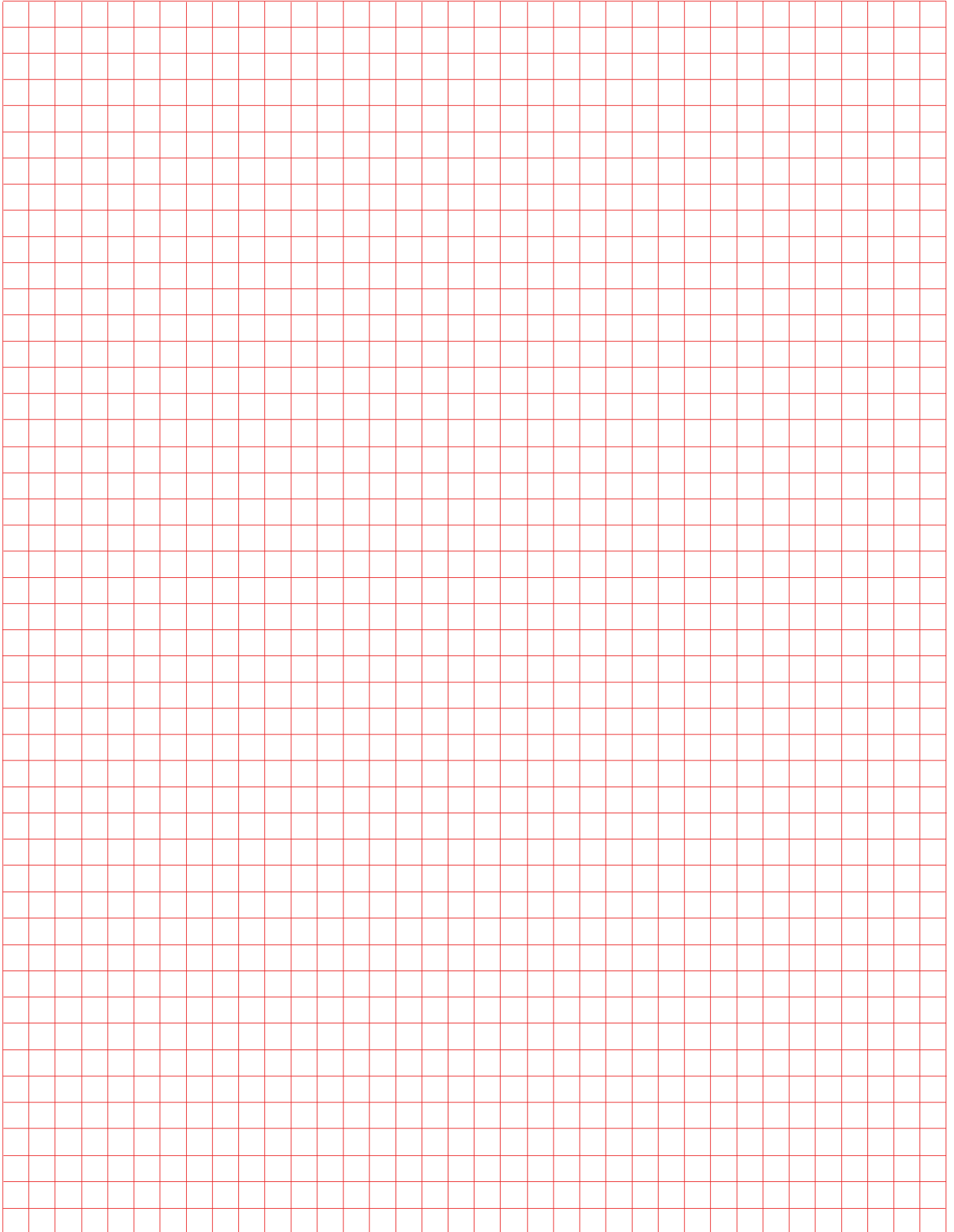
A large grid of red lines on a white background, intended for taking notes. The grid consists of 20 columns and 30 rows of small squares.

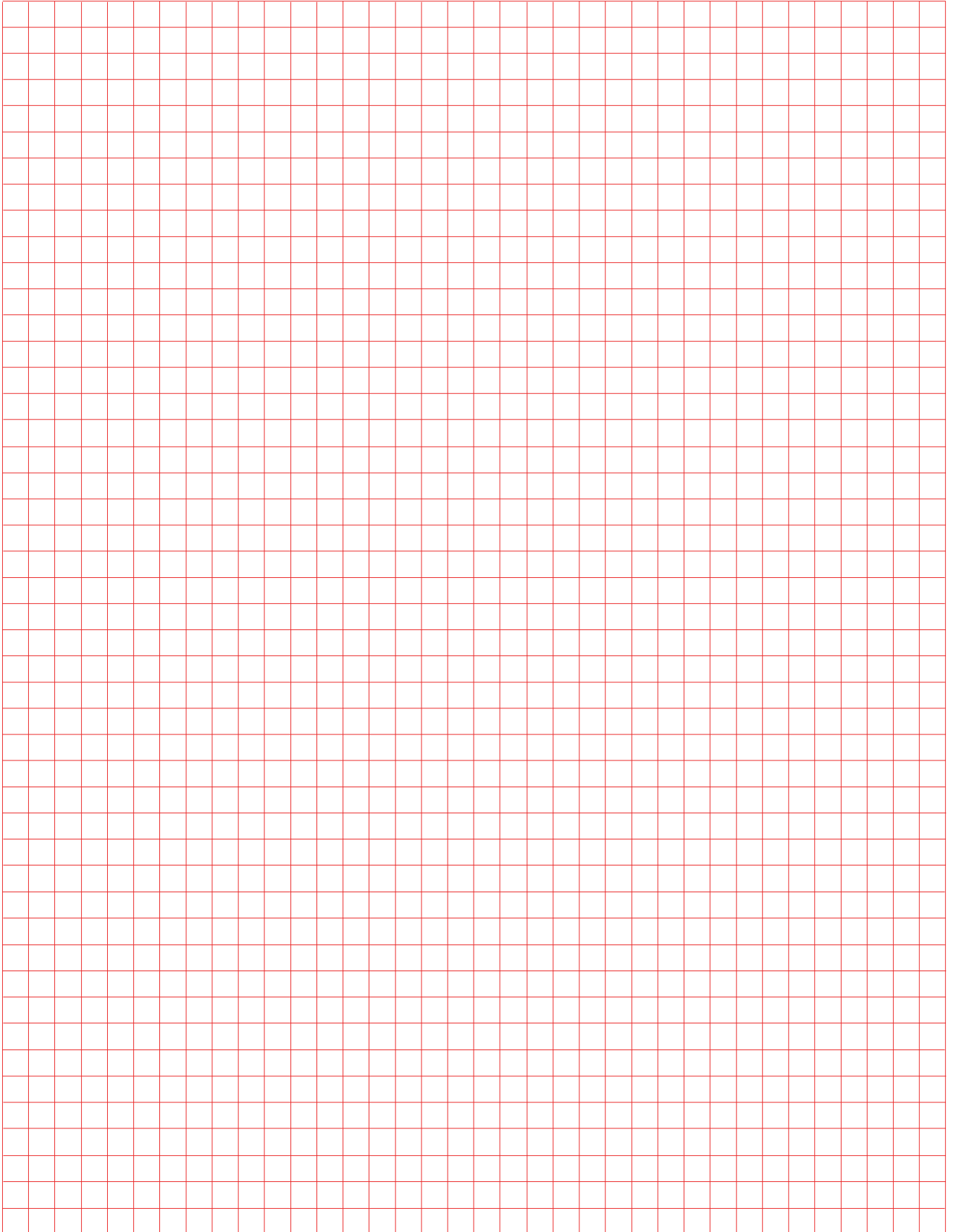

Notes

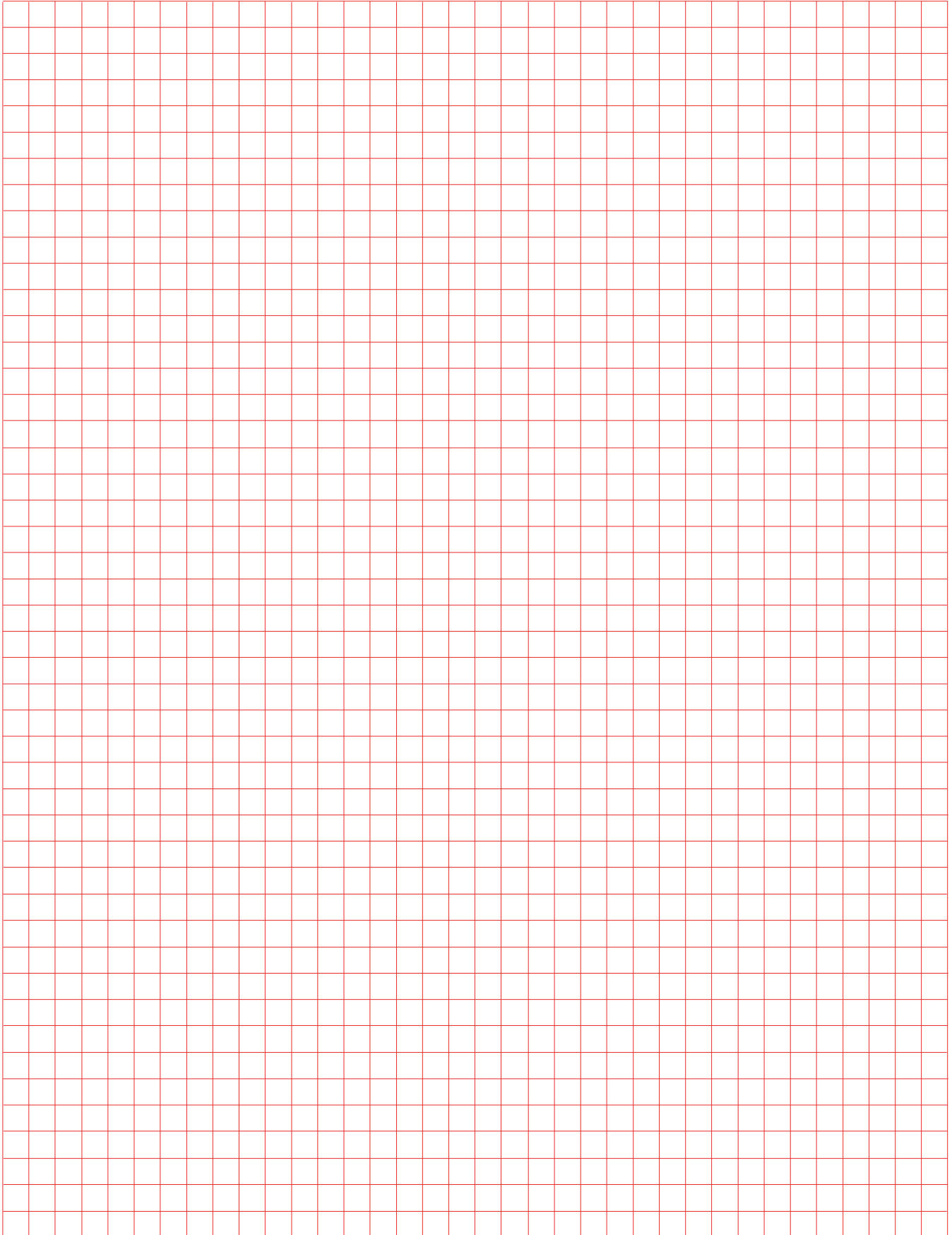
A large grid of red lines on a white background, intended for taking notes. The grid consists of 20 columns and 30 rows of small squares.

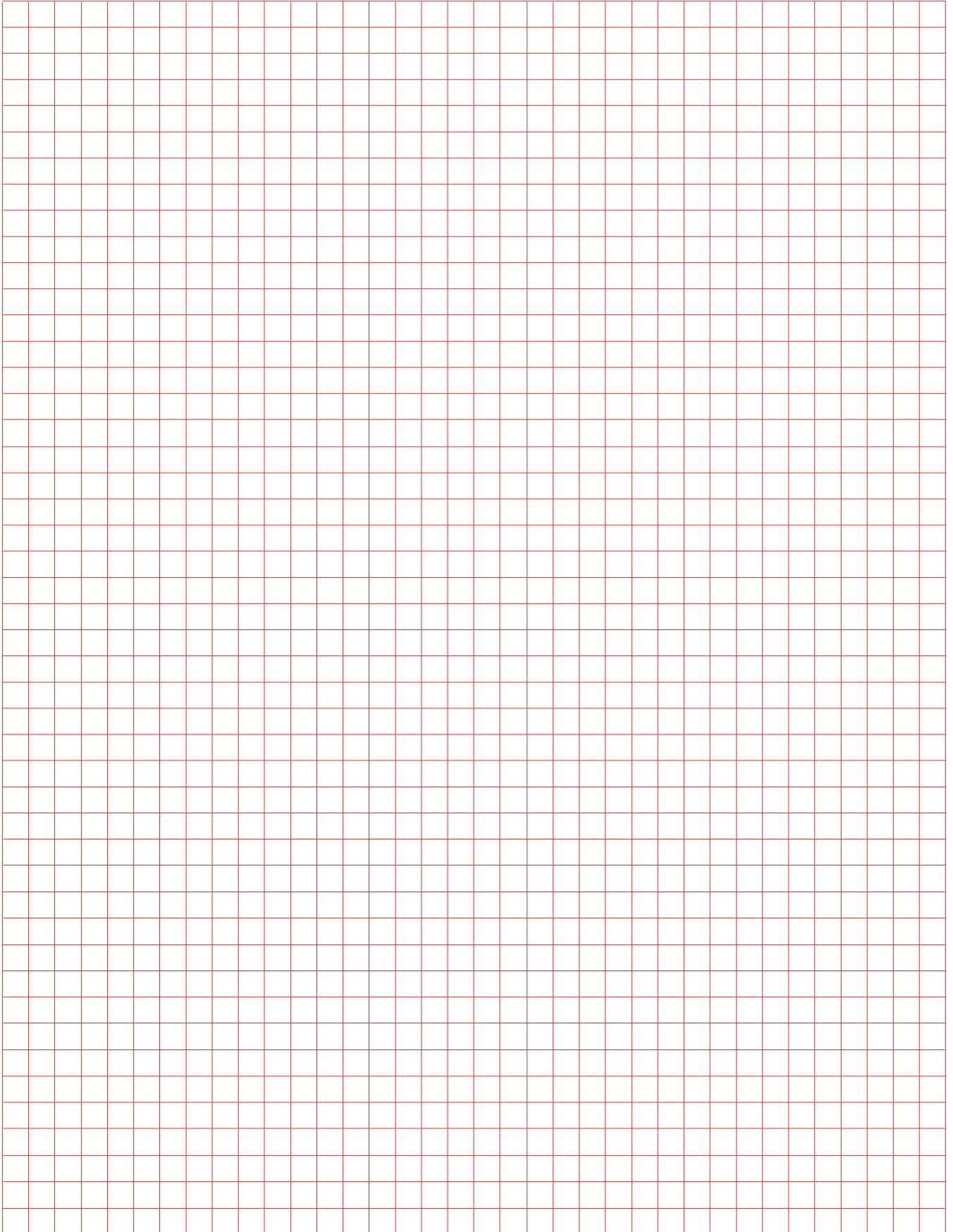

Notes

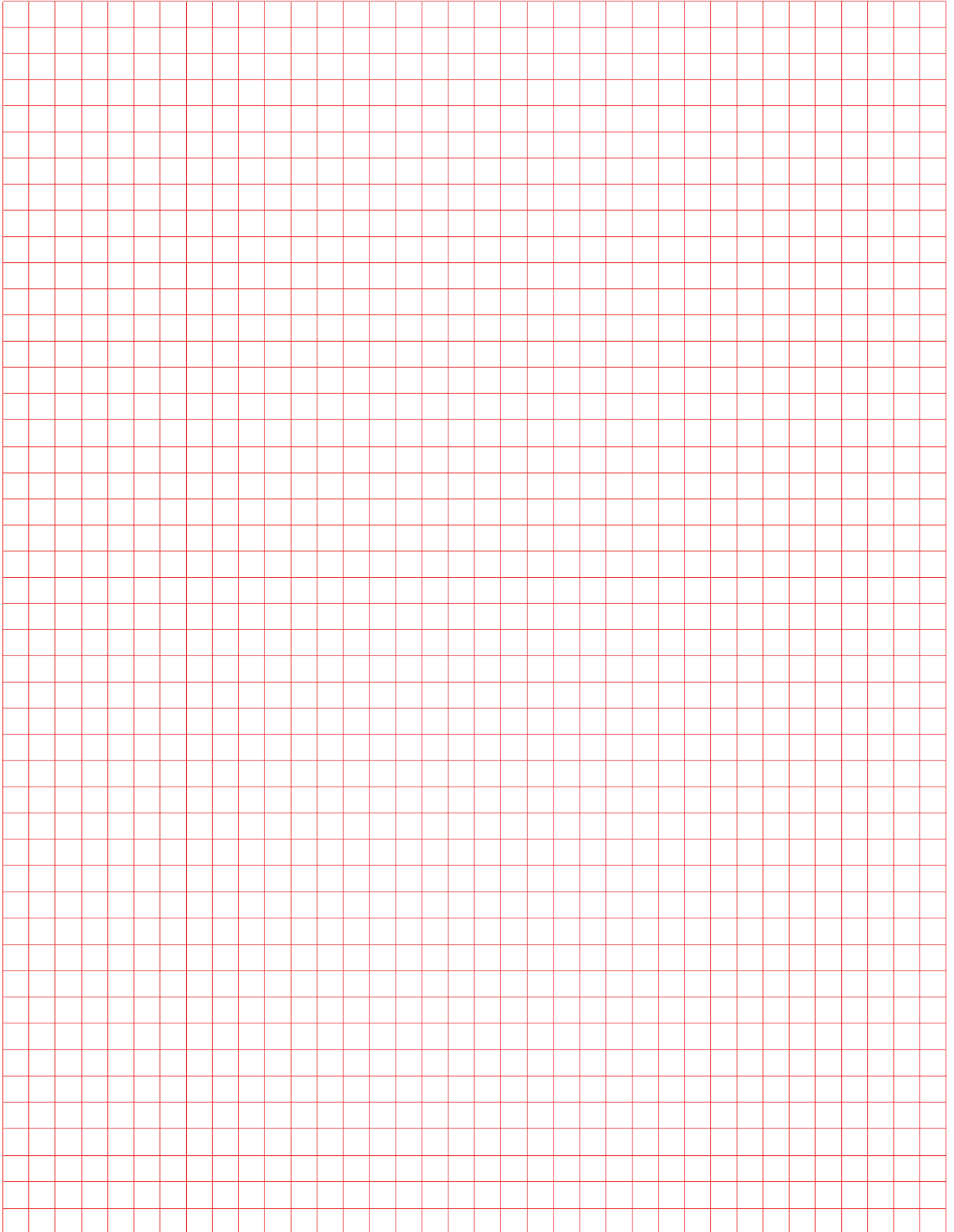
A large grid of red lines on a white background, intended for taking notes. The grid consists of 20 columns and 30 rows of small squares.

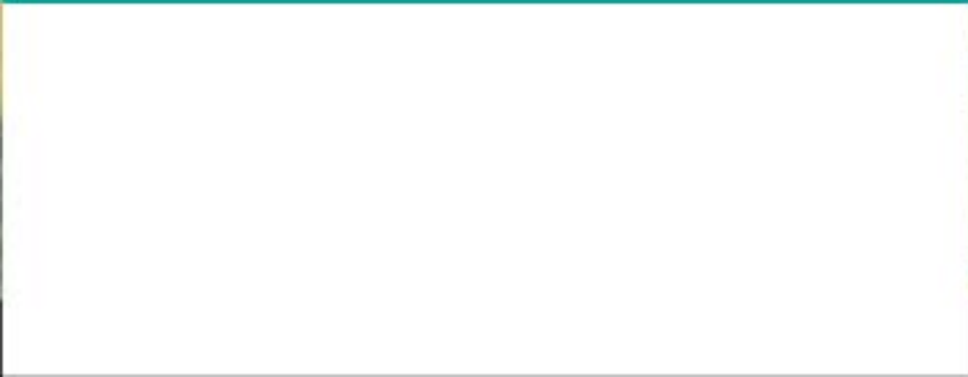
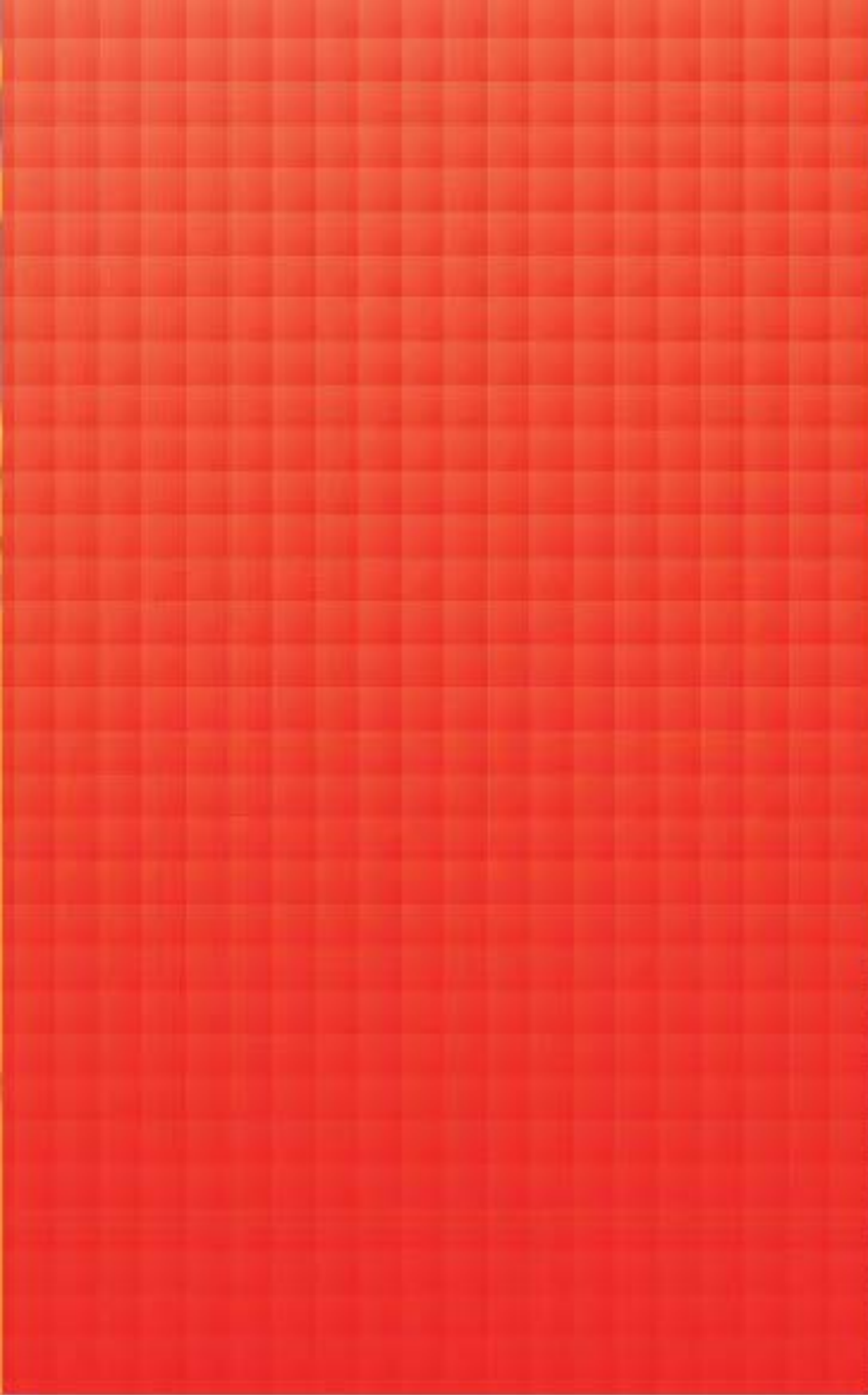



TREADWELL™

Treadwell Access Systems, EX-Series®, GratEX®, GridEX®, MoultrEX® and StormChief® are all registered brands of Treadwell Group Pty Ltd. All pictures and information are supplied as a guide only. The complete range of Treadwell products are developed, refined and made to meet and exceed stringent specifications for the worldwide market.

Important Note: Sales of products are subject to our Terms and Conditions which are available upon request. All specifications and photos are a guide only and are subject to change without notice. Please ring to confirm details. Treadwell products only comply with relevant standards mentioned within this publication when installed and used as they are designed to be.

