

ArchitEX™
Structural Profiles & Structures

Structural Product Guide

Global leaders in the supply of Engineer
Designed Fibreglass Reinforced Plastic (FRP)
Structural Profiles and Solutions



TREADWELL™

The Treadwell team is delighted to introduce the latest revision of our ArchitEX™ Structural Product Guide, showcasing the largest range of Fibreglass Reinforced Plastic (FRP) profiles in the market and the ultimate tool for designing FRP structures.

The data in this FRP Structural Product Guide has been collated to ensure that engineers and architects have the ideal reference available to them while designing structures that incorporate FRP Pultrusions.

While this guide offers a huge resource of information and statistics relevant to FRP Structural profiles, it is impossible to embrace the flexibility and constant evolution of the ArchitEX™ FRP composite range in one publication. To ensure that you have the most up to date information on the ArchitEX™ range of profiles and applications or to simply draw on our team's experience in this unique industry, contact us via the relevant numbers or visit www.treadwellgroup.com.au

This product guide is also available online, so if you are concerned that your copy may not be the latest, you can request an updated hardcopy or download it at www.treadwellgroup.com.au.

A BRIEF HISTORY

Treadwell Group is one of the most established names in the supply of Access Systems throughout Australia. Our centrally located Adelaide fabrication facility, coupled with our second to none distribution network across Australia, and our commitment to quality and testing, allows our technical staff to provide engineering and design assistance for any project.

With a broad history of installation in a wide range of challenging applications, including industrial process plants, mining applications, marine and coastal environments, as well as public infrastructure, Treadwell has the experience to help you specify the right resin systems and products every time.

If you have any unique design problems, chances are we've encountered something similar before. Get in contact today.

Treadwell Group Pty Ltd

Australia
P 1800 246 800
sales@treadwellgroup.com.au
treadwellgroup.com.au

New Zealand
P 0800 244 600
sales@treadwellgroup.co.nz
treadwellgroup.co.nz



quantity of reinforce-
optimise economy,
create or enhance
a pultruded part.
ide glass or carbon
at (long fibres held
or stitched fabrics.



Mining and Minerals



Aquaculture

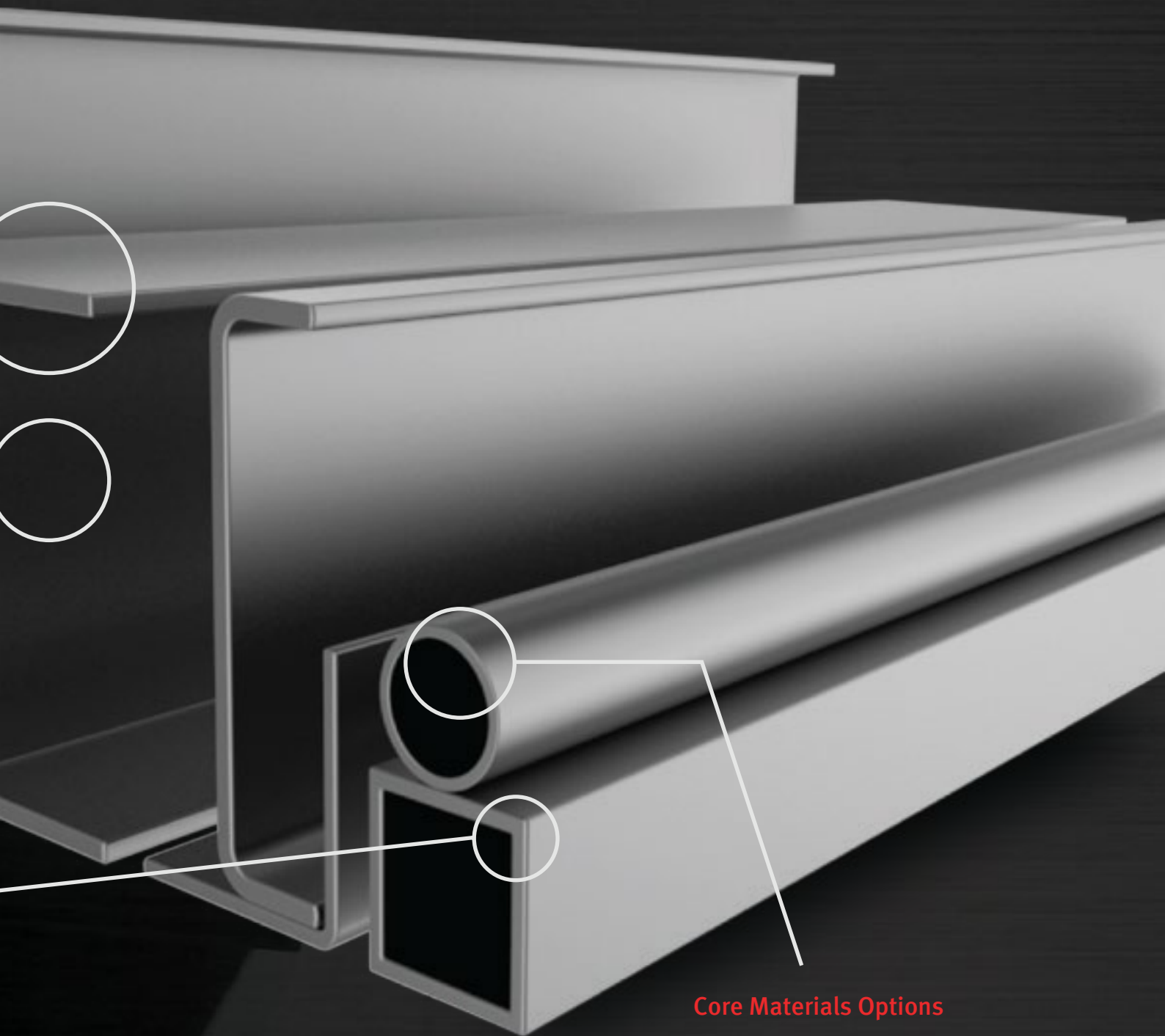

Core Materials Options

Treadwell provides a range of core material options with comprehensive experience in pultruding over various materials including foam, balsa, polyethylene and aluminium.

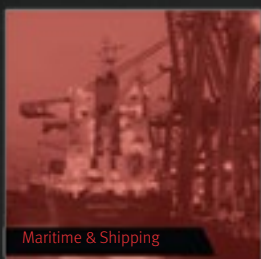

Maritime & Shipping



Chemicals and Petro Chemicals



Pulp and Paper

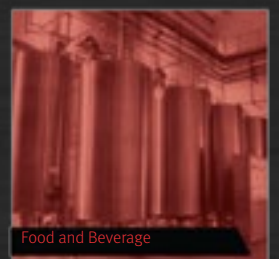

Food and Beverage



Section One: Introduction to Pultrusions

- 06 Composition of Pultrusions
- 07 Resin Systems
- 08 The Pultrusion Process
- 09 Environmental Conditions

Section Two: Coupon Properties

- 10 ArchitEX™ Profiles
- 11 Typical Properties of Threaded Rod/Nuts
- 12 Typical Coupon Properties of Flat Sheet
- 13 Comparison

Section Three: General Tolerances

- 15 Cross Sectional Tolerance
- 17 Straightness
- 18 Twist

Section Four: Sectional Properties

- 21 C Section
- 23 I-Beam
- 25 WF-Beam
- 26 Double Web Beam & Unequal Leg Angle
- 27 Equal Leg Angle
- 29 Rectangular Hollow Section
- 30 Circular Hollow Section
- 31 Solid Bar
- 32 Circular Round Bar
- 33 Embedment Angle
- 34 Square Hollow Section



Quality Policy

Quality is at the forefront of Treadwell Access Systems' working practices. With over 15 years of manufacturing to the highest quality standards, Treadwell Access Systems prides itself on its implementation of strict quality control measures, and strives to supply products that surpass customers' expectations. The company works on a policy of continuous improvement.



Environmental Policy

Treadwell Access Systems is conscious of the impact it has on the environment and its associated responsibilities. The company is committed to ensuring its operations satisfy both legal obligations and moral duties. Treadwell has been committed to sustainability for many years and is not just responding to current trends.

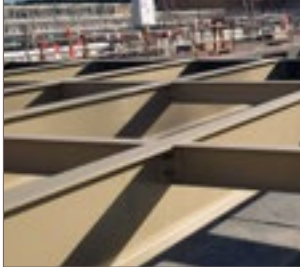

Section Five: Beams - Allowable Uniform Loads

- 37 Allowable Uniform Loads Tables
- 40 Technical Data Tables - C Section
- 51 Technical Data Tables - I-Beam
- 62 Technical Data Tables - WF-Beam
- 70 Technical Data Tables - Double Web Beam
- 72 Technical Data Tables - Rectangular Hollow Section
- 75 Technical Data Tables - Square Hollow Section
- 82 Technical Data Tables - Interlocking Deckboard
- 86 Technical Data Tables - Flat Sheet

Section Six: Columns

- 93 Columns

Section Seven: Columns - Allowable Concentric Axial Stresses and Loads

- 96 Technical Data Tables - Angle
- 104 Technical Data Tables - I-Beam
- 114 Technical Data Tables - WF-Beam
- 124 Technical Data Tables - Double Web Beam
- 126 Technical Data Tables - Square Hollow Section
- 137 Technical Data Tables - Rectangular Hollow Section

Section Eight: SPACE GASS Input Guide

- 138 SPACE GASS Input Guide

Section Nine: Corrosion Guide

- 140 Corrosion Guide

Introduction to Pultrusions

Composition of FRP Pultrusions

What are pultrusions made of?

Pultrusions are composed of two key elements; glass fibre products and resin formulations. The glass contributes its inherent tensile flexural strength while the addition of resin ensures impact and corrosion resistance.

The glass fibre component normally consists of two different arrangements: glass roving which is unidirectional, and continuous mat which can be arranged in different ways to provide bi-directional stability as well as contributing to longitudinal strength properties.

Another integral part of a pultrusion is the surface veil which provides enhanced UV protection, corrosion resistance and aesthetics.

Roving

Roving is made up of fibreglass unidirectional filaments which are manufactured on continuous rolls. Roving is usually the principal element in a pultrusion, comprising 50% - 70% percent of the total glass content.

While supplying the necessary strength to pull the profile during manufacture, the roving also provides unsurpassed tensile and flexural properties. The percentage of roving in a pultrusion is the major variable in section stiffness.

Mat

Continuous strand mat constitutes the remainder of the glass reinforcement used in the pultrusion process. This would typically be 30% - 50% of the total glass content. It is important to differentiate between continuous strand mat and other hand-laid-up or press-moulded processes that utilise short chopped fibres. The mat that is used in the pultrusion process requires good tractive strength to ensure that it enters the die properly.

Fibreglass continuous strand mat is predominately applied to obtain the desired transverse properties of the product, whereas roving provides longitudinal stability to a section. Roving lacks the required lateral cohesion that is also an essential element in maintaining the maximum strength from a profile, it is the continuous strand mat that is principally responsible for this.

Surface Veil

Veils are utilised to enhance the surface properties of pultruded profiles. Most widely used today are synthetic variations which enhance the UV resistance properties and aesthetics. The veil also increases the resin content of the surface of the pultrusion which provides added corrosion resistance.

Cross Section of Pultrusion

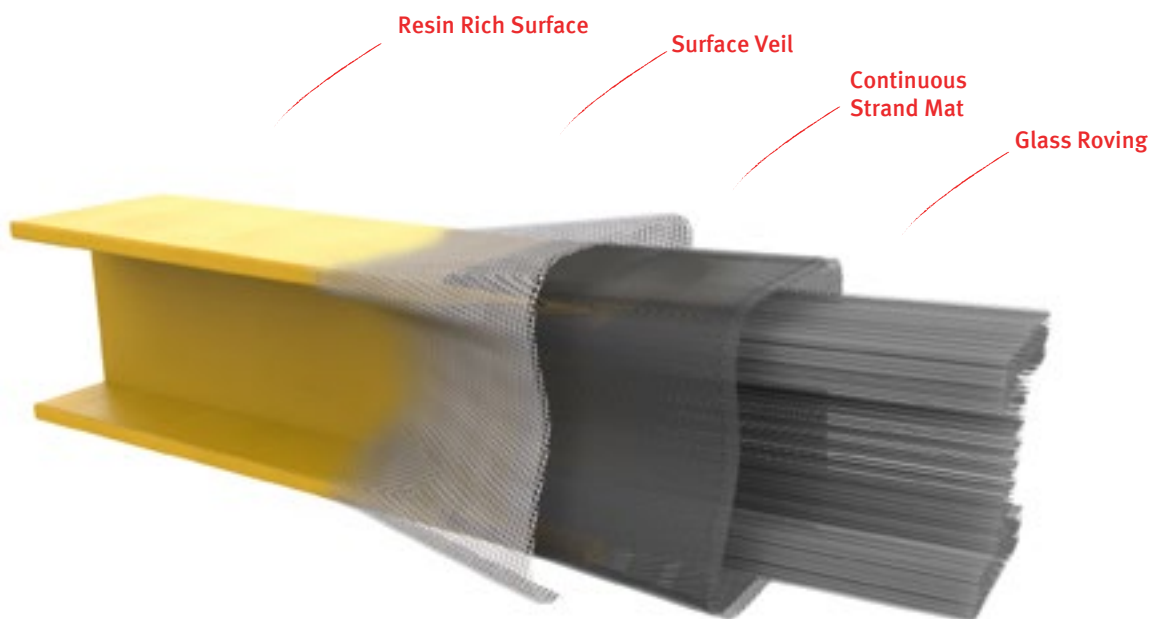

Resin Systems

When choosing a resin type for your application, we highly recommend you consult with us in relation to the application to ensure the correct resin is specified. Considerations such as corrosion, environment, temperature, fire resistance, smoke and smoke toxicity requirements must be taken into account, and will dictate which resin system should be utilised for optimum performance over time. Below is an overview of the resin systems offered in the ArchitEX™ range.

O-Series® is an architectural grade polyester resin system with an intermediate level of chemical resistance, and is a good choice for commercial or light industrial applications, especially in areas where moisture is prevalent. O-Series® is often utilised for public infrastructure applications where it has been proven to outperform traditional timber decking products. This system is available with or without fire retardant additives.

I-Series® is a premium isophthalic resin system. This system provides an intermediate level of chemical resistance and is the correct choice for areas subjected to splash and spill contact with harsh chemicals. This system is an excellent general-purpose resin and is a more favourably priced alternative to the vinylester system. This system has a flame spread of 25 (approximately 15) or less.

V-Series® Vinylester resin is the most high quality chemical resistant system offered in the industry and has been developed for use in environments where FRP products are subject to frequent and direct contact with the harshest of chemical, including a broad range of acids and caustics. This system has a flame spread of 25 (approximately 15) or less.

P-Series® The phenolic resin system is a system designed specifically for use where fire resistance, low smoke and low toxic fumes are critical. P-Series® is typically used in offshore applications and confined spaces where such criteria are an absolute necessity. This system is tested in accordance with ASTM E-84. Various products also conforming to US Coast Guard Approvals, Level 2 and 3, are also offered by Treadwell. This particular resin system has a flame spread rating of 5 and a smoke density rating of 5.

Standards Resin Systems Comparison Chart

	Chemical Resistance	Fire Retardance	Low Smoke	Halogen Free	Temperature Performance
O-Series® Polyester	● ● ●	● ● ● ●	—	—	● ● ●
I-Series® Isophthalic	● ● ● ● ●	● ● ● ● ●	—	—	● ● ● ●
V-Series® Vinylester	● ● ● ● ●	● ● ● ● ●	—	—	● ● ● ● ●
P-Series® Phenolic	● ● ● ●	● ● ● ● ●	● ● ● ●	● ● ● ● ●	● ● ● ● ●

ArchitEX™ Features and Benefits vs. Traditional Alternatives

	ArchitEX™	Stainless Steel	Galvanised Steel	Aluminium	Polyurethane
Chemical Resistance	● ● ● ● ●	● ● ● ●	●	● ● ●	● ● ● ●
Strength	● ● ● ● ●	● ● ● ● ●	● ● ● ● ●	● ● ● ● ●	● ● ●
Lightweight	● ● ● ● ●	●	●	● ● ● ● ●	● ● ●
Electrical Resistance	● ● ● ● ●	●	●	●	● ● ● ● ●
Cost Effectiveness	● ● ● ● ●	● ● ●	● ● ● ●	● ●	● ● ● ● ●

Introduction to Pultrusions

The Pultrusion Process

How the Pultrusion Machine Works

Pultruding is the process that is used to form continuous structural profiles out of fibreglass and resin composites. The process is performed by a pultrusion machine. The first pultrusion process was developed in the mid-1940s with further major development and greater recognition in the mid-1950s.

The term pultrusion was derived from a combination of the word pull and extrusion. There are some parallels between the two processes given that they both produce continuous profiles and involve some sort of forming die. The main difference being that the pultrusion process utilises a series of pullers, which draw the product through the entire process as compared to extruding, which uses pressure or a pushing force.

The pultrusion process commences with fibreglass roving being pulled off rolls, through a guide and then being combined with the continuous strand mat. It is this fibreglass component that provides the resistance to tension that is necessary in the pultrusion process. The raw fibre is pulled through a series of guides or rollers and then enters a resin impregnation bath. The resin is usually a thermo-setting resin.

Now that the fibres are thoroughly 'wetted out' with the resin, they pass through a series of tooling which arranges the fibres correctly and removes excesses of resin. This set of tooling and guides is referred to as the pre-former. At this stage, the surface veil is added.

The uncured composite is then pulled into a heated die which commonly consists of 2-3 differing stages of temperature which initiate the curing of the resin component. The profile that exits the die is now a cured pultruded fibreglass reinforced plastic composite.

It is this rigid profile that is gripped further down the line by the pulling mechanism which provides steady and continuous tractive effort. After passing through the pullers, the FRP profile reaches a cut-off saw. The saw cuts the pultrusion to the desired length without slowing or halting the process.

This way high strength and light weight profiles can be created from fibreglass reinforced plastic to virtually any length required.

Pultrusion Machine

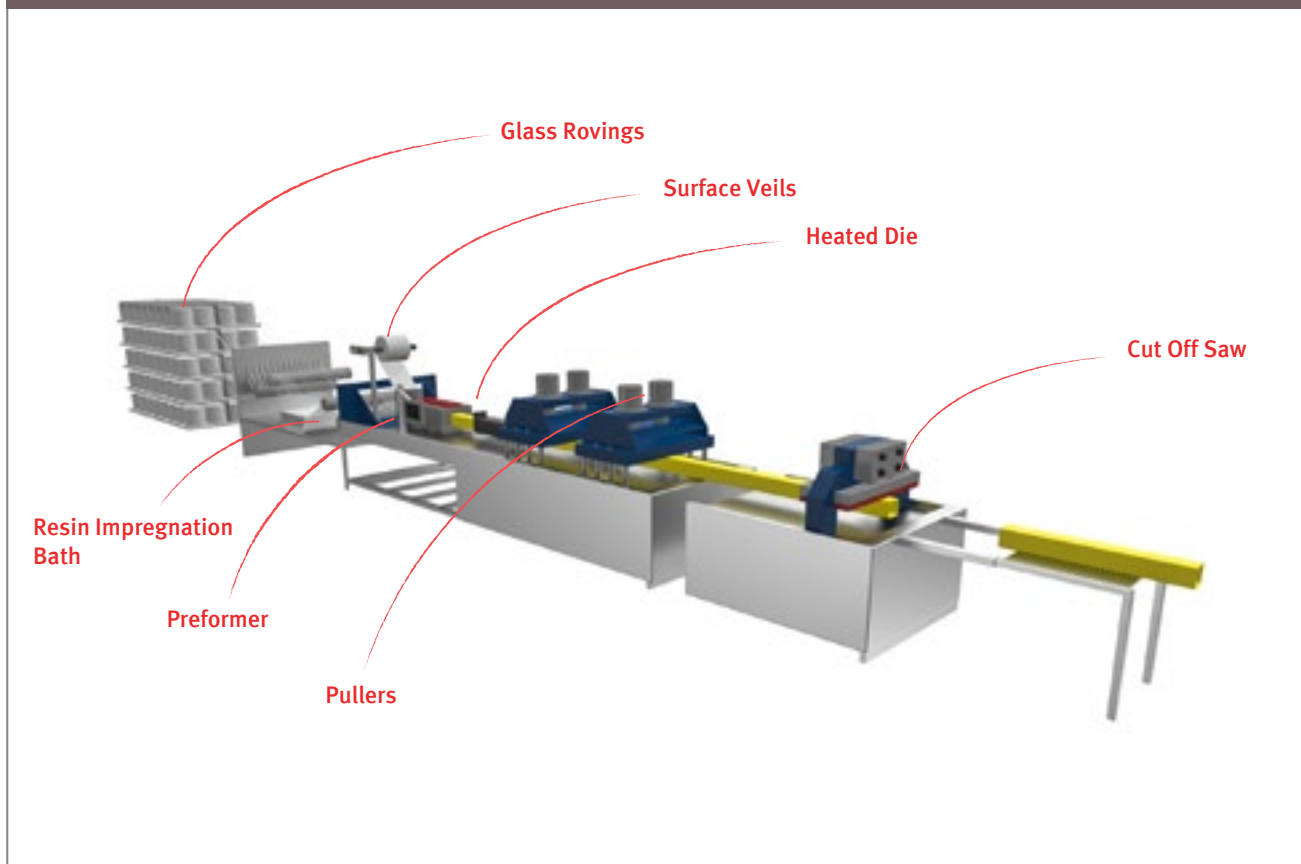

Environmental Conditions

Temperature

When designing a structure that is going to incorporate FRP sections, it is essential to consider environment changes such as temperature. Continued exposure to elevated temperatures can cause polyester and vinylester fibreglass pultrusions to lose certain percentages of their properties.

These tables shows the percentage of property retention when exposed to certain continuous temperatures.

Ultimate Stress

Temperature	Polyester	Vinylester
37°C	85%	90%
51°C	70%	80%
65°C	50%	80%
79°C	Not Recommended	75%
93°C	Not Recommended	50%

Modulus of Elasticity

Temperature	Polyester	Vinylester
37°C	100%	100%
51°C	90%	95%
65°C	85%	90%
79°C	Not Recommended	88%
93°C	Not Recommended	85%

Weathering

As with most plastic products, fibreglass reinforced pultrusions will undergo some form of visual degradation when exposed to outdoor weathering.

Typically, the surface of ArchitEX™ Pultrusions have good water and ambient temperature resistant properties but are susceptible to ultra-violet(UV) light. UV light is the light spectrum between 290 and 400 nanometres. This light has a higher energy and causes significant degradation to polymers by breaking chemical bonds or starting chemical reactions. The fire retardant polyester formulations contain a halogen which makes these plastics typically more susceptible to UV light degeneration.

Deterioration that has been caused by UV light can be identified by 'fade' and 'yellowing' on the pultrusion surface. Over an extended period of exposure, the actual glass fibres closest to the surface will become exposed. This state is known as fibrebloom and does not directly or immediately affect the physical properties of the section.

Treadwell adds a UV stabiliser into the resin formulation. This is especially important due to the extreme exposure that our products experience in the Pacific region. Also, to ensure that our pultruded products endure a protracted lifespan, we use high quality polyester surface veils to ensure that the structural component of the composite is protected as well as possible from damaging and corroding elements.

The ArchitEX™ range is also offered with a range of exterior coatings to enhance aesthetics. If a Urethane coating is applied, this will also provide a hugely effective protection barrier to outdoor weathering.

Pultrusion Availability

Treadwell is arguably the largest stockist of FRP pultrusion products in Australia. We always stock a comprehensive range of I-Beam, C Section, Hollow Section and Angle products which are commonly in high demand. Due to the consistent and rapid evolution of the fibreglass pultrusion market, we are continually reevaluating our range of stocked products to ensure that our holdings accurately reflect customer demand.

We utilise efficient transport networks across Australia to ensure rapid delivery to remote locations and stock products in most capital cities.

Our complete range of products available is listed in the Section Properties tables. To obtain price and availability or find out if the product you require is a stock item, call Treadwell on 1800 246 800.



Coupon Properties

ArchitEX™ Profiles

Below are test results for typical coupon properties of Treadwell Group’s structural fibreglass profiles. Properties are derived per the ASTM test method shown. Synthetic surfacing veil and ultraviolet inhibitors are standard.

Mechanical Properties	ASTM	Units	Value
Tensile Stress, LW	D-638	MPa	206.8
Tensile Stress, CW	D-638	MPa	48.2
Tensile Modulus, LW	D-638	GPa	17.2
Tensile Modulus, CW	D-638	GPa	5.5
Compressive Stress, LW	D-695	MPa	206.8
Compressive Stress, CW	D-695	MPa	103.4
Compressive Modulus, LW	D-695	GPa	17.2
Compressive Modulus, CW	D-695	GPa	6.9
Flexural Stress, LW	D-790	MPa	206.8
Flexural Stress, CW	D-790	MPa	68.9
Flexural Modulus, LW	D-790	GPa	12.4
Flexural Modulus, CW	D-790	GPa	5.5
Modulus of Elasticity, E	Full Section	GPa	19.3
Shear Modulus	--	GPa	3.1
Short Beam Shear	D-2344	MPa	31.0
Punch Shear	D-732	MPa	68.9
Notched Izod Impact, LW	D-256	J/mm	1.33
Notched Izod Impact, CW	D-256	J/mm	0.21

Physical Properties	ASTM	Units	Value
Barcol Hardness	D-2583	----	45
24 Hour Water Absorbtion	D-570	% max.	0.45
Density	D-792	g/cc	1.72-1.94
Coefficient of Thermal Expansion, LW	D-696	10 ⁶ cm./cm./°C	12

Electrical Properties	ASTM	Units	Value
Arc Resistance, LW	D-495	seconds	120
Dielectric Strength, LW	D-149	kv./mm	1.37
Dielectric Strength, PF	D-149	volts/mil.	200
Dielectric Constant, PF	D-150	@60hz	5

Fire Retardant Polyester and Fire Retardant Vinylester Structural Profiles:			
Flammability Properties	ASTM	Units	Value
Tunnel Test	E-84	Flame Spread	25 max.
Flammability	D-635	--	Nonburning
UL	94	VO	
NBS Smoke Chamber	E-662	Smoke Density 600-700	

CW = Crosswise	LW = Lengthwise	PF = Perpendicular to Laminate Face
----------------	-----------------	-------------------------------------

Typical Properties of Threaded Rod / Nuts

Treadwell Group's threaded rod and nuts are manufactured using premium vinyl ester resin containing UV inhibitors. The properties listed below are the result of the ASTM test method indicated.

Properties	ASTM	Units	Diameter - Threads per Inch (UNC)					
			9.5mm	12.7mm	15.9mm	19.0mm	25.4mm	
Ultimate Transverse Shear (Double Shear)	B-565	Newton	18,680	30,240	44,480	59,600	106,750	
Longitudinal Compressive Strength	D-695	MPa	344	344	344	344	344	
Flexural Strength	D-790	MPa	482	482	482	482	482	
Flexural Modulus	D-790	GPa	17.2	17.2	17.2	17.2	17.2	
Flammability	D-635	Self-extinguishing for all						
Fire Retardant	Class 1							
Water Absorption (24 hr. immersion)	D-570	% max.	0.8	0.8	0.8	0.8	0.8	
Longitudinal Coefficient of Thermal Expansion	D-696	10 ⁻⁶ mm/mm/°C	11	11	11	11	11	
Ultimate Thread Shear (using fibreglass nut)	-- --	Newton	5,337	10,670	16,010	17,790	36,470	
Ultimate Torque Strength (fibreglass nut lubricated with SAE 10W30 motor oil)		NewtonMeter	10	21	47	67	149	
Rod Weight	-- --	Kg./m	0.104	0.119	0.297	0.447	0.789	
Nut Weight	-- --	grams	4.5	9.1	18.1	27.2	63.6	
Nut Dimensions	-- --	mm.(square) x mm.(thick)	17.2 x 11.4	21.8 x 14.2	26.9 x 17.5	31.5 x 20.8	41.4 x 27.9	
Color	Gray							

Typical Properties of Rod, Bar, and Flat Sheet

Below are test results for typical coupon properties of Treadwell Group's Rod, Bar, and Flat Sheet reinforced with all unidirectional longitudinal fibreglass roving. Properties are derived per the ASTM test method shown.

Properties	ASTM	Units	Rod	Bar	Flat Sheet
Tensile Stress	D-638	MPa	620.5	165.5	620.5
Tensile Modulus	D-638	GPa	34.7	27.6	34.7
Compressive Stress	D-695	MPa	413.7	344.7	344.7
Flexural Stress	D-790	MPa	689.5	620.5	689.5
Flexural Modulus	D-790	GPa	41.4	31.0	31.0
Barcol Hardness	D-2583		60	60	60
Izod Impact	D-256	J/mm	2.14	2.14	2.14
Density	D-792	gr/cc	1.80-2.07	1.80-2.07	1.80-2.07
Water Absorption (24 hour)	D-570	%	0.2	0.2	0.2

Coupon Properties

Typical Coupon Properties of Flat Sheet

Below are test results for typical coupon properties of Treadwell Group's Flat Sheet. Properties are derived per the ASTM test method shown. Synthetic surfacing veil and ultraviolet inhibitors are standard.

Mechanical Properties	ASTM	Units	Thickness					
			STD & FR			VE		
			3.2	4.8 - 6.4	9.5 - 25.4	3.2	4.80 - 6.4	9.5 - 25.4
Tensile Stress, LW	D-638	MPa	165.5	165.5	165.5	165.5	165.5	165.5
Tensile Stress, CW	D-638	MPa	51.7	68.9	68.9	51.7	68.9	68.9
Tensile Modulus, LW	D-638	GPa	13.8	13.8	13.8	13.8	13.8	13.8
Tensile Modulus, CW	D-638	GPa	6.9	7.6	9.6	6.9	7.6	9.6
Compressive Stress, LW	D-695	MPa	165.5	165.5	165.5	165.5	165.5	165.5
Compressive Stress, CW	D-695	MPa	106.9	113.8	113.8	113.8	120.7	120.7
Compressive Modulus, LW	D-695	GPa	12.4	12.4	12.4	12.4	12.4	12.4
Compressive Modulus, CW	D-695	GPa	6.9	6.9	6.9	6.9	6.9	6.9
Flexural Stress, LW	D-790	MPa	241.3	241.3	206.8	241.3	241.3	206.8
Flexural Stress, CW	D-790	MPa	103.4	103.4	124.1	103.4	103.4	124.1
Flexural Modulus, LW	D-790	GPa	11.0	13.8	13.8	11.0	13.8	13.8
Flexural Modulus, CW	D-790	GPa	6.2	7.6	9.6	6.2	7.6	9.6
Perpendicular Shear Stress, LW	D-3846	MPa	41.3	41.3	41.3	41.3	41.3	41.3
Perpendicular Shear Stress, CW	D-3846	MPa	41.3	41.3	41.3	41.3	41.3	41.3
Bearing Stress, LW	D-953	MPa	220.6	220.6	220.6	220.6	220.6	220.6
Notched Izod Impact, LW	D-256	J/mm	0.99	1.1	1.1	1.0	1.1	1.06
Notched Izod Impact, CW	D-256	J/mm	0.27	0.3	0.3	0.3	0.3	0.27

Physical Properties								
Barcol Hardness	D-2583	---	40.0	40.0	40.0	40.0	40.0	40.0
24 Hour Water Absorption	D-570	% max.	0.6	0.6	0.6	0.6	0.6	0.6
Density	D-792	g/cc	1.72 - 1.94	1.72 - 1.94	1.72 - 1.94	1.72 - 1.94	1.72 - 1.94	1.72 - 1.94
Coefficient Thermal Expansion, DW	D-696	10 ⁻⁶ mm/mm /°C	8.0	8.0	8.0	8.0	8.0	8.0

Electrical Properties								
Arc Resistance, LW	D-495	seconds	120.0	120.0	120.0	120.0	120.0	120.0
Dielectric Strength, LW	D-149	kv./mm	1.37	1.37	1.37	1.37	1.37	1.37
Dielectric Strength, PF	D-149	volts/mil.	200.0			200.0		

Flammability Properties For FR and VE				
Tunnel Test	E-84	Flame Spread 25 max.	CW	Crosswise
Flammability	D-635	Non-burning	LW	Lengthwise
UL	94	VO	PF	Perpendicular to Laminate Face
NBS Smoke Chamber	E-662	Smoke Density 600-700		



COMPARE

	ArchitEX™	vs	Steel
Corrosion Resistance	ArchitEX™ is available in either polyester or vinylester resin for resistance to a broad range of chemicals. Painting is beneficial in assisting with UV resistance when subjected to prolonged exposure.		Subject to oxidation and corrosion. Requires painting or galvanizing for many applications.
Weight	Lightweight - weight 25% as much as steel. 12.7mm thick plate = 0.002295 kgf/cm ²		Could require lifting equipment to move and place. 12.7mm thick plate = 0.00996 kgf/cm ²
Conductivity	Low electrical conductivity properties - high dielectric capability Low thermal conductivity 4 (BTU/SF/HR/F°/IN).		Conducts electricity. Potential Shock Hazard Thermal Conductivity 260-460 (BTU/SF/HR/F°/IN).
Strength	ArchitEX™ has a high strength-to-weight ratio and pound-for-pound is stronger than steel in the lengthwise direction. Tensile strength = 30 KSI , CW = 7 KSI		Homogeneous material. Tensile strength = 60 KSI Yield strength = 36 KSI
Stiffness	Modulus of Elasticity = 2.5 MSI Will not permanently deform under working load.		Flexural modulus = 29 KSI Modulus of Elasticity = 29 MSI
Impact Resistance	Glass mats in ArchitEX™ distributes impact load to prevent surface damage. Will not permanently deform under impact.		Can permanently deform under impact.
EMI/RFI Transparency	Transparent to EMI/RFI transmissions.		Can interfere with EMI/RFI transmissions.
Versatility	Pigments added to the resin provide color throughout the part. Special colors available.		Must be painted for color. To maintain color and corrosion resistance, repainting may be required.
Easy Field Fabrication	ArchitEX™ can be field fabricated using simple carpenter tools with carbide or diamond tip blades. Lightweight for easier erection and installation.		Often requires welding and cutting torches. Heavier material requires special handling equipment to erect and install.
Cost	Lower installation and maintenance costs in industrial applications often equals lower lifecycle costs.		Lower initial cost.

General Tolerances



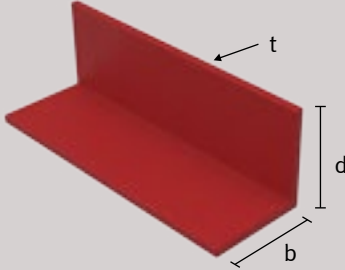
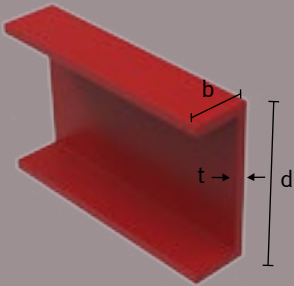
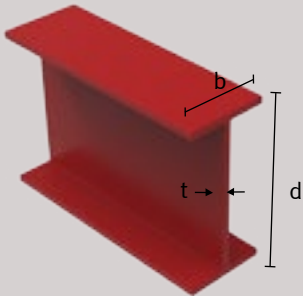
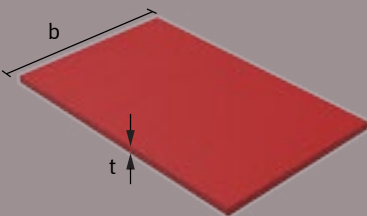

Cross Sectional Tolerances

Shapes	Dimension	Tolerance % of Nominal	* Maximum or Minimum Tolerances
<p>Angles</p> 	t = thickness	± 10 %	± 0.26mm min.
	b = flange width	± 4 %	± 2.4mm max.
	d = depth	± 4 %	± 2.4mm max.
<p>C Sections</p> 	t = thickness	± 10 %	± 0.26mm min.
	b = flange width	± 4 %	± 2.4mm max.
	d = depth	± 4 %	± 2.4mm max.
<p>Beams</p> 	t = thickness	± 10 %	± 0.26mm min.
	b = flange width	± 4 %	± 2.4mm max.
	d = depth	± 4 %	± 2.4mm max.
<p>Flat Sheet</p> 	t = thickness	± 15 % ± 10 %	0.25mm min 1.27mm max
	b = width	± 4 %	± 2.4mm max.

General Tolerance

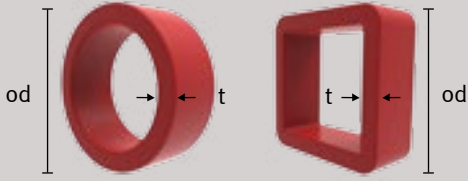
Cross Sectional Tolerance

Shapes	Dimension	Outside Dimension Condition	Tolerances
Closed Shapes Round, Square and Rectangular Tubes 	t = thickness	All	0.25mm min
	od = outside dimension	All	2.39mm max
Round Rod & Square Bar 	od = outside dimension	All	2.39mm max

Flatness

Flatness is measured in the center with the weight of the profile minimising the deviation by contact with a flat surface

Structural Shapes Rods, Bars & Flat Sheet 	Allowable deviation from flat		
	Width	All Thickness	
	Up to 25.4mm	0.2mm	
	Over 25.4mm	6.3mm	
Hollow Shapes 	Allowable deviation from flat		
	Width	Thickness under 4.8mm	Thickness 4.8mm and over
	Up to 25.4mm	0.3mm	0.2mm
	Over 25.4mm	0.3mm x width	4.8mm x width

Straightness

Straightness is measured in the centre with the weight of the pultrusion minimising the deviation by contact with a flat surface.

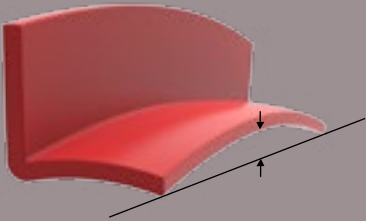
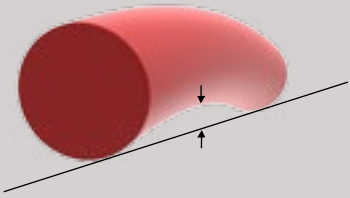
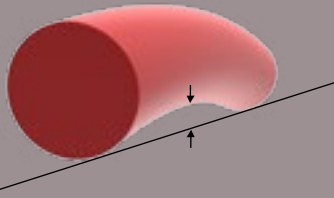
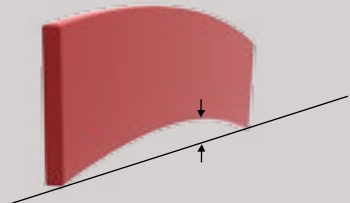
<p>Angle, Beam and C Section</p> 	<p>Allowable deviation from straight</p>		
<p>Rods and Bars</p> 	<p>Width</p>	<p>Thickness</p>	<p>Allowable deviation from straight</p>
<p>Round, Square, and Rectangular Tube</p> 	<p>Allowable deviation from straight</p>		
<p>Flat Sheet and Plate</p> 	<p>Allowable deviation from straight</p>		
	<p>All widths</p>	<p>0.5 mm/m</p>	
	<p>(38.1mm)</p>	<p>----</p>	<p>4.17mm/m</p>
		<p>2.4mm and over</p>	<p>3.33mm/m</p>
	<p>(38.1mm) and over</p>	<p>All thickness</p>	<p>3.33mm/m</p>
	<p>Diameter/Depth</p>	<p>Per Meter</p>	
	<p>All</p>	<p>2.5mm</p>	
	<p>All thickness and widths</p>	<p>2.5mm</p>	

General Tolerance

Twist

Twist is measured with the weight of the pultrusion minimising the twist.

Bars and other Structural Profiles other than Tubes	Allowable twist	
	0.003°/mm	
Closed Profiles (Tubes)	Allowable twist	
	0.003°/mm	

Angularity

Angularity is the angle measured between two perpendicular faces of the profile.

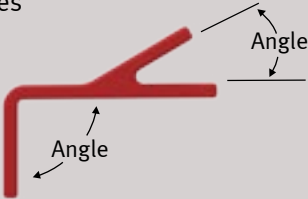
All Profiles	Allowable deviation from specific angle	
	Thickness up to 19mm	2°

Cut Lengths

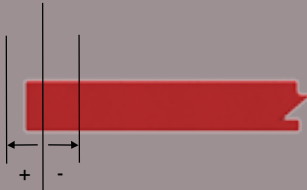
All Profiles	Allowable deviation from specific length	
	up to 2.44m	0 + 6.35mm
	2.44m <= 7.32m	0 + 12.7mm
	> 7.32m	0 + 76.2mm

*All parts being cut from stock must allow for blade width

Squareness of Endcut

	Allowable deviation from specific length	
All Profiles	Profiles 50.8mm and under	± 2°
	Profiles over 50.8mm	± 1°

Sectional Properties



Sectional Properties

Elements of Sections of Structural Shapes

The section table values on the following pages have been calculated from nominal dimensions. All shapes shown in the tables are available, but not all are stocked. A shape availability list is included in the manual and, for convenience, availability information is noted on the individual uniform load tables.

Notation	
A	cross sectional area (in. ² / mm. ²)
A _w	area of web (in. ² / mm. ²)
b	width of section (in. / mm.)
d	depth of section / diameter of rod (in. / mm.)
h	depth between flanges (in. / mm.)
I	moment of inertia (in. ⁴ / mm. ⁴)
J	torsion constant (in. ⁴ / mm. ⁴)
od	outside diameter of tube (in. / mm.)
r	radius of gyration (in. / mm.)
S	section modulus (in. ³ / mm. ³)
t	thickness (in. / mm.)
t _b	thickness of width dimension (in. / mm.)
t _f	thickness of flange (in. / mm.)
t _d	thickness of depth dimension (in. / mm.)
t _w	thickness of web (in. / mm.)
Wt.	weight of section (lbs./ft. / kg./m.)
C _x	x coordinate of centroid (mm.)
C _y	y coordinate of centroid (mm.)

Sectional Properties - C Section

The section values shown on this page have been calculated from the nominal dimensions of the profile. All the shapes listed in the table are available but not all are stocked. For information on availability and price, contact Treadwell Group on 1800 246 800.

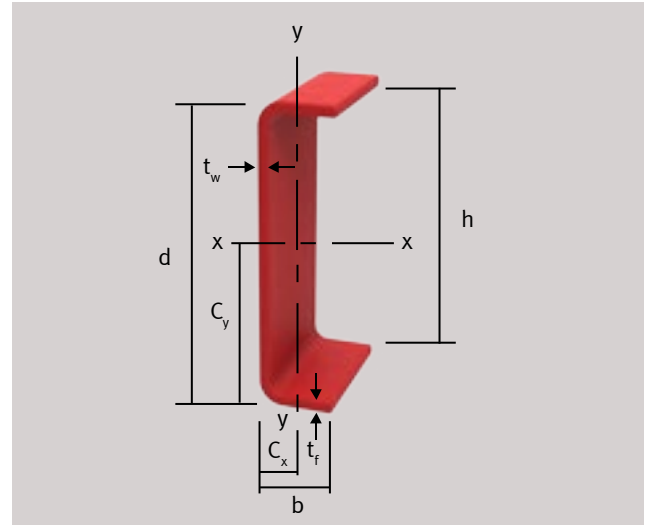

C Section		Sectional Dimensions						
Part	Part Number	d mm	b mm	t _w mm	t _f mm	h mm	C _x mm	C _y mm
		Web	Flange					
50.8x14x3.2mm CSection	F-P-CS(51/14/3.2)	50.8	14.2	3.2	3.2	44.75	3.761685	25.4
76.2x22.2x6.4mm CSection	F-P-CS(76/22/6.4)	76.2	22.2	6.4	6.4	63.5	6.443382	38.1
76.2x25.4x6.4mm CSection	F-P-CS(76/25/6.4)	76.2	25.4	6.4	6.4	63.5	7.408333	38.1
76.2x38.1x6.4mm CSection	F-P-CS(76/38/6.4)	76.2	38.1	6.4	6.4	63.5	11.83409	38.1
88.9x3.2x30.2x4.8mm CSection	F-P-CS(89/3.2/30/4.8)	88.9	30.2	3.2	4.8	79.375	8.775759	44.45
88.9x38.1x4.8mm CSection	F-P-CS(89/38/4.8)	88.9	38.1	4.8	4.8	79.375	10.54554	44.45
101.6x28.6x6.4mm CSection	F-P-CS(102/29/6.4)	101.6	28.6	6.4	6.4	88.9	7.52337	50.8
101.6x34.9x4.8mm CSection	F-P-CS(102/35/4.8)	101.6	34.9	4.8	4.8	92.075	8.886887	50.8
139.7x38.1x6.4mm CSection	F-P-CS(140/38/6.4)	139.7	38.1	6.4	6.4	127	9.128125	69.85
152.4x41.3x6.4mm CSection	F-P-CS(152/41/6.4)	152.4	41.3	6.4	6.4	139.7	9.661071	76.2
152.4x42.9x9.5mm CSection	F-P-CS(152/43/9.5)	152.4	42.9	9.5	9.5	133.35	11.28505	76.2
203.2x55.6x9.5mm CSection	F-P-CS(203/56/9.5)	203.2	55.6	9.5	9.5	184.15	13.42547	101.6
254x69.9x12.7mm CSection	F-P-CS(254/70/12.7)	254	69.9	12.7	12.7	228.6	17.18879	127
292.1x69.9x12.7mm CSection	F-P-CS(292/70/12.7)	292.1	69.9	12.7	12.7	266.7	16.17266	146.05
304.8x76.2x12.7mm CSection	F-P-CS(305/76/12.7)	304.8	76.2	12.7	12.7	279.4	17.55588	152.4
355.6x88.9x19.1mm CSection	F-P-CS(356/89/19.1)	355.6	88.9	19.1	19.1	317.5	22.06218	177.8
457.2x60.32x9.5mm CSection	F-P-CS(457/60/9.5)	457.2	60.3	9.5	9.5	438.15	10.24659	228.6

Sectional Properties

C Section				Section Properties							
Part	Part Number	X - X			Y - Y						
		I mm ⁴	S mm ³	r mm	I mm ⁴	S mm ³	r mm	J mm ⁴	A _w mm ²	Area mm ²	Weight Kg./m
50.8x14x3.2mm C Section	FP-CS(51/14/3.2)	7475763	2943205	1795644	336677	3198575	3810652	801.059	141.129	231.854375	0.417666
76.2x22.2x6.4mm C Section	FP-CS(76/22/6.4)	4807251	1261742	2648197	2343411	1484895	5846909	944916	403.225	685.4825	1.234838
76.2x25.4x6.4mm C Section	FP-CS(76/25/6.4)	530044.2	1391188	2702379	349569	1942.944	6939956	998979	403.225	725.805	1.307475
76.2x38.1x6.4mm C Section	FP-CS(76/38/6.4)	727320.3	1908972	2863374	1153159	4390.313	11.40144	123349	403.225	887095	1.598025
88.9x3.2x30.2x4.8mm C Section	FP-CS(89/3.2/30/4.8)	6413126	1442769	3448375	4643771	2171.325	9.279295	29917	252.016	539313438	0.971527
88.9x38.1x4.8mm C Section	FP-CS(89/38/4.8)	8414172	1892947	3369912	9605844	3486.12	11.38625	5810.04	378.023	740.925938	1.334714
101.6x28.6x6.4mm C Section	FP-CS(102/29/6.4)	1196122	2354562	3591289	5386832	255886	7621304	129976	564.515	9274175	1.670663
101.6x34.9x6.4mm C Section	FP-CS(102/35/4.8)	1090307	2146268	3760107	7766579	2982765	10.03554	6064.38	438.507	771.167813	1.389192
139.7x38.1x6.4mm C Section	FP-CS(140/38/6.4)	3236630	4633673	5008388	1374565	4744467	10.32129	179573	806.45	1290.32	2.3244
152.4x41.3x6.4mm C Section	FP-CS(152/41/6.4)	4239811	5564041	5481075	1778747	5626449	11.22663	195501	887095	1411.2875	2.542313
152.4x42.9x9.5mm C Section	FP-CS(152/43/9.5)	6055368	7946655	5386933	2727084	8636152	11.43196	632443	1270.159	2086.68938	3.758991
203.2x55.6x9.5mm C Section	FP-CS(203/56/9.5)	14890522	1465598	7276279	635340	1507791	15.02995	26711.2	1754.029	2812.49438	5.066466
254x69.9x12.7mm C Section	FP-CS(254/70/12.7)	38492696	303091.2	9071658	1659560	3151382	18.83623	254501	2903.22	467741	8.42595
292.1x69.9x12.7mm C Section	FP-CS(292/70/12.7)	54725705	374704.2	1029715	1717580	3199813	18.24231	280536	338709	5161.28	9.2976
304.8x76.2x12.7mm C Section	FP-CS(305/76/12.7)	64394404	422534.2	108.363	2246678	38310.27	20.24079	297902	3548.38	5483.86	9.8787
355.6x88.9x19.1mm C Section	FP-CS(356/89/19.1)	146822233.4	8257695	124.7425	5061997	75735.3	23.16218	1160000	6048.375	9435.465	16.99718
457.2x60.32x9.5mm C Section	FP-CS(457/60/9.5)	124352263.10	543971.6	1528503	9613887	1919761	13.43968	160640	4173.379	5322.57	9.58815

Sectional Properties

Sectional Properties – I-Beam

The section values shown on this page have been calculated from the nominal dimensions of the profile. All the shapes listed in the table are available but not all are stocked. For information on availability and price, contact Treadwell Group on 1800 246 800.

*457.20 I Beam - Web = 9.53mm Flange = 12.70mm

*609.60 I Beam - Web = 9.53mm Flange = 19.05mm

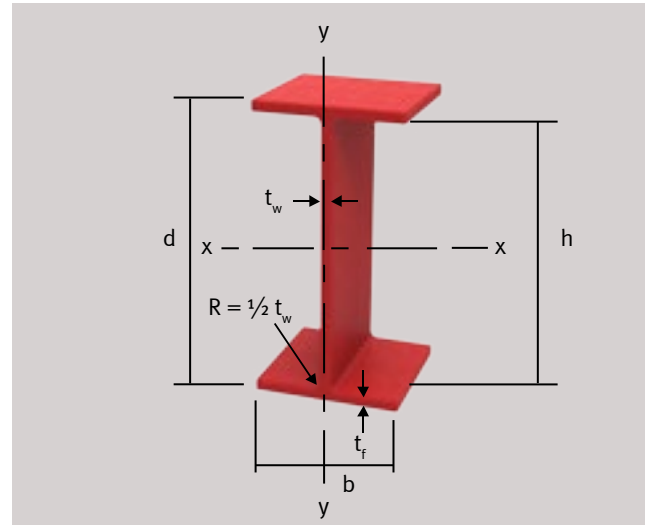

I-Beam		Sectional Dimensions				
Part	Part Number	d mm	b mm	t _w mm	t _f mm	h mm
		Web	Flange			
76.2 x 38.1 x 6.4mm I-Beam	F-P-IS(76/38/6.4)	76.2	38.1	6.4	6.4	6350
88.9 x 38.1 x 4.8mm I-Beam	F-P-IS(89/38/4.8)	88.9	38.1	4.8	4.8	7938
101.6 x 50.8 x 6.4mm I-Beam	F-P-IS(102/51/6.4)	101.6	50.8	6.4	6.4	8890
139.7 x 63.5 x 6.4mm I-Beam	F-P-IS(140/64/6.4)	139.7	63.5	6.4	6.4	12700
152.4 x 76.2 x 6.4mm I-Beam	F-P-IS(152/76/6.4)	152.4	76.2	6.4	6.4	13970
152.4 x 76.2 x 9.5mm I-Beam	F-P-IS(152/76/9.5)	152.4	76.2	9.5	9.5	13335
203.2 x 101.6 x 9.5mm I-Beam	F-P-IS(203/102/9.5)	203.2	101.6	9.5	9.5	18415
203.2 x 101.6 x 12.7mm I-Beam	F-P-IS(203/102/12.7)	203.2	101.6	12.7	12.7	17780
254 x 127 x 9.5mm I-Beam	F-P-IS(254/127/9.5)	254	127	9.5	9.5	23495
254 x 127 x 12.7mm I-Beam	F-P-IS(254/127/12.7)	254	127	12.7	12.7	22860
304.8 x 152.4 x 12.7mm I-Beam	F-P-IS(305/152/12.7)	304.8	152.4	12.7	12.7	27940
457.2 x 9.5 x 114.3 x 12.7mm I-Beam	F-P-IS(457/9.5/114/12.7)	457.2	114.3	9.5	12.7	43180
609.6 x 9.5 x 190.5 x 19.1mm I-Beam	F-P-IS(610/9.5/191/19.1)	609.6	190.5	9.5	19.1	57150

Sectional Properties

I-Beam		Section Properties									
Part	Part Number	X-X			Y-Y						
		I mm ⁴	S mm ³	r mm	I mm ⁴	S mm ³	r mm	J mm ⁴	A _w mm ²	Area mm ²	Weight Kg./m
76.2X38.1X6.4mm I-Beam	FPIS(76/38/6.4)	727321.06	1908979	28.63	5988746	314370	822	129787	403.23	88688	1.60
88.9X38.1X4.8mm I-Beam	FPIS(89/38/4.8)	841418.03	1892954	33.70	4461392	234194	776	603838	378.02	740.74	1.33
101.6X50.8X6.4mm I-Beam	FPIS(102/51/6.4)	1837271.53	3616676	38.97	14064070	553704	1078	176635	564.52	1209.38	2.18
139.7X63.5X6.4mm I-Beam	FPIS(140/64/6.4)	4671764.18	6688281	53.82	27369384	862028	1303	234328	806.45	1612.5	2.91
152.4X76.2X6.4mm I-Beam	FPIS(152/76/6.4)	6606589.95	86700.66	59.68	47124118	1236853	1594	266937	887.10	1854.38	3.34
152.4X76.2X9.5mm I-Beam	FPIS(152/76/9.5)	9301187.11	12206282	58.46	71199353	1868749	1617	861055	1270.16	2721.09	4.90
203.2X101.6X9.5mm I-Beam	FPIS(203/102/9.5)	23121371.16	22757255	79.16	167818698	3303518	2133	116564	1754.03	3688.59	6.65
203.2X101.6X12.7mm I-Beam	FPIS(203/102/12.7)	29396344.43	28933410	77.94	225025114	4429628	2157	275449	2258.06	4837.5	8.72
254X127X9.5mm I-Beam	FPIS(254/127/9.5)	46462849.07	36584921	99.88	326872758	5147602	2649	146271	2237.90	4656.09	8.39
254X127X12.7mm I-Beam	FPIS(254/127/12.7)	59642494.69	46962594	98.65	437476571	6889395	2671	346832	2903.22	6127.5	11.04
304.8X152.4X12.7mm I-Beam	FPIS(305/152/12.7)	105705439.13	69360524	119.36	753983884	9894828	3188	417940	3548.38	7417.5	13.37
457.2X95X114.3X12.7mm I-Beam	FPIS(457/95/114/12.7)	207348286.11	90703537	171.91	319185200	5585044	2133	288053	4112.90	7014.38	12.64
609.6X95X190.5X19.1mm I-Beam	FPIS(610/95/191/19.1)	781189968.36	256295921	248.00	2199085978	23087817	41.61	1060000	5443.54	12698.44	22.88

Sectional Properties

Sectional Properties - WF-Beam

The section values shown on this page have been calculated from the nominal dimensions of the profile. All the shapes listed in the table are available but not all are stocked. For information on availability and price, contact Treadwell Group on 1800 246 800.

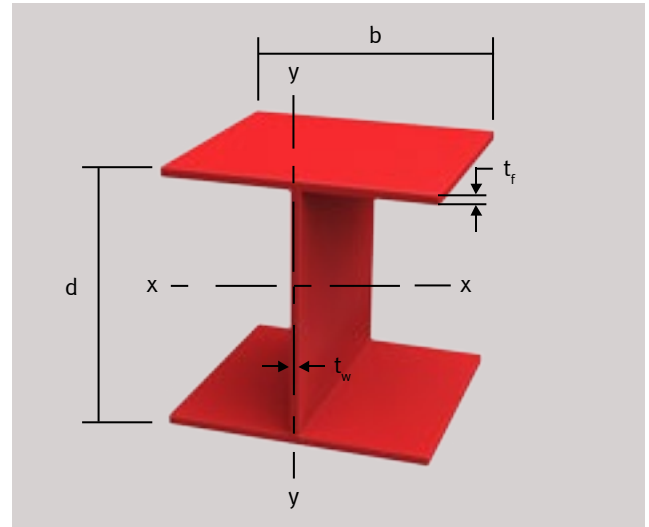

WF-Beam		Section Dimensions						Section Properties					
Part	Part Number	d mm	b mm	t _w mm	t _f mm	Area mm ²	Weight Kg./m	X-X			Y-Y		
		Web	Flange	I mm ⁴	S mm ³			r mm	I mm ⁴	S mm ³	r mm		
76.2 x 6.4mm WF-Beam	F-P-WFB(76/6.4)	76.2	76.2	6.4	6.4	1374.2	2.44	1319454	34577	31.0	470342	12290	18.5
101.6 x 6.4mm WF-Beam	F-P-WFB(102/6.4)	101.6	101.6	6.4	6.4	1864.5	3.20	3304878	65057	42.2	1111338	21959	24.4
152.4 x 6.4mm WF-Beam	F-P-WFB(152/6.4)	152.4	152.4	6.4	6.4	2832.3	5.06	11771025	154530	64.5	3750245	49161	36.3
152.4 x 9.5mm WF-Beam	F-P-WFB(152/9.5)	152.4	152.4	9.5	9.5	4180.6	7.29	16720016	219423	63.2	5627449	73906	36.6
203.2 x 9.5mm WF-Beam	F-P-WFB(203/9.5)	203.2	203.2	9.5	9.5	5632.2	9.66	41285995	406399	85.6	13331893	131260	48.8
203.2 x 12.7mm WF-Beam	F-P-WFB(203/12.7)	203.2	203.2	12.7	12.7	7425.8	12.95	52844742	520125	84.3	17789731	175178	49.0
254 x 9.5mm WF-Beam	F-P-WFB(254/9.5)	254.0	254.0	9.5	9.5	7135.5	13.01	82634425	650730	107.7	26031113	205002	60.5
254 x 12.7mm WF-Beam	F-P-WFB(254/12.7)	254.0	254.0	12.7	12.7	9361.3	16.22	106638491	839673	106.9	34722026	273336	61.1
304.8 x 12.7mm WF-Beam	F-P-WFB(305/12.7)	304.8	304.8	12.7	12.7	11296.8	19.64	188323909	1236404	129.0	59983111	393617	72.9

Sectional Properties

Sectional Properties - Double Web Beam

The section values shown on this page have been calculated from the nominal dimensions of the profile. All the shapes listed in the table are available but not all are stocked. For information on availability and price, contact Treadwell Group on 1800 246 800.

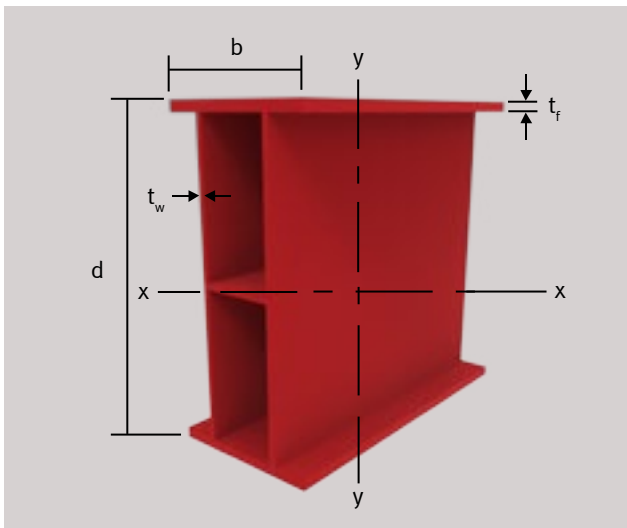

Double Web Beam		Section Dimensions					Section Properties			
Part	Part Number	d mm	b mm	t _w mm	t _f mm	A _w mm ²	Weight Kg./m	I _{xx} mm ⁴	A mm ²	I _{yy} mm ⁴
		Web	Flange							
225 x 475mm Double Web Beam	F-P-DWB(225/475 /10/16)	475	225	10	16	8860	28.908	5.24E+08	16060	5.24E+08

Sectional Properties - Unequal Leg Angle

The section values shown on this page have been calculated from the nominal dimensions of the profile. All the shapes listed in the table are available but not all are stocked. For information on availability and price, contact Treadwell Group on 1800 246 800.

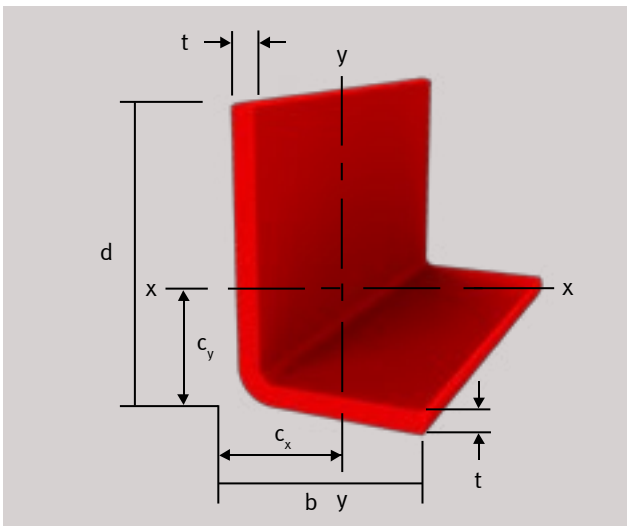

Unequal Leg Angle		Section Dimensions							Section Properties					
Part	Part Number	d mm	b mm	t mm	C _x mm	C _y mm	Area mm ²	Weight Kg./m	X-X			Y-Y		
									I mm ⁴	S mm ³	r mm	I mm ⁴	S mm ³	r mm
1524x101.6x12.7mm Unequal Leg Angle	FP-UELA (152/102/12.7)	152.4	101.6	12.7	25.45	51.44	2981	5.37	6995262	69287	48.442	2532460	33256	29.147

Sectional Properties - Equal Leg Angle

The section values shown on this page have been calculated from the nominal dimensions of the profile. All the shapes listed in the table are available but not all are stocked. For information on availability and price, contact Treadwell Group on 1800 246 800.

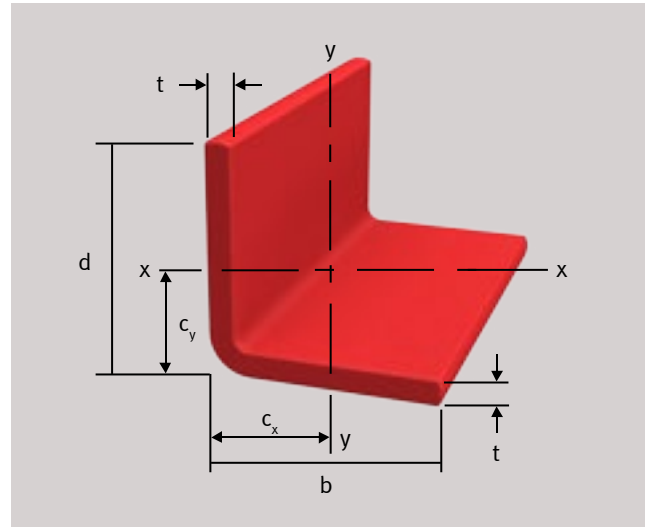

Equal Leg Angle		Section Dimensions						Section Properties		
Part	Part Number	d mm	b mm	t mm	C _x /C _y mm	Area mm ²	Weight Kg./m	I mm ⁴	S mm ³	r mm
25.4 x 3.2mm Equal Leg Angle	F-P-ELA(25/3.2)	25.4	25.4	3.2	7.51	151.17	0.27	9042.40	505.56	7.73
31.8 x 3.2mm Equal Leg Angle	F-P-ELA(32/3.2)	31.8	31.8	3.2	9.11	191.48	0.35	18291.87	807.85	9.77
38.1 x 4.8mm Equal Leg Angle	F-P-ELA(38/4.8)	38.1	38.1	4.8	11.27	339.29	0.61	45676.24	1702.44	11.60
38.1 x 6.4mm Equal Leg Angle	F-P-ELA(38/6.4)	38.1	38.1	6.4	11.83	443.44	0.80	57658.00	2195.17	11.40
50.8 x 6.4mm Equal Leg Angle	F-P-ELA(51/6.4)	50.8	50.8	6.4	15.03	604.69	1.09	144678.36	4044.50	15.47
76.2 x 6.4mm Equal Leg Angle	F-P-ELA(76/6.4)	76.2	76.2	6.4	21.40	927.19	1.67	517891.66	9450.02	23.63
76.2 x 9.5mm Equal Leg Angle	F-P-ELA(76/9.5)	76.2	76.2	9.5	22.54	1360.55	2.45	732434.19	13650.17	23.20
76.2 x 12.7mm Equal Leg Angle	F-P-ELA(76/12.7)	76.2	76.2	12.7	23.67	1773.75	3.20	922528.08	17561.32	22.80
101.6 x 6.4mm Equal Leg Angle	F-P-ELA(102/6.4)	101.6	101.6	6.4	27.76	1249.69	2.25	1265062.58	17131.47	31.81
101.6 x 9.5mm Equal Leg Angle	F-P-ELA(102/9.5)	101.6	101.6	9.5	28.91	1844.30	3.32	1814196.10	24959.13	31.36
101.6 x 12.7mm Equal Leg Angle	F-P-ELA(102/12.7)	101.6	101.6	12.7	30.06	2418.75	4.36	2314853.73	32355.97	30.93
152.4 x 9.5mm Equal Leg Angle	F-P-ELA(152/9.5)	152.4	152.4	9.5	41.63	2811.80	5.07	6404379.33	57818.72	47.72

Sectional Properties

Sectional Properties – Rectangular Hollow Section

The section values shown on this page have been calculated from the nominal dimensions of the profile. All the shapes listed in the table are available but not all are stocked. For information on availability and price, contact Treadwell Group on 1800 246 800.

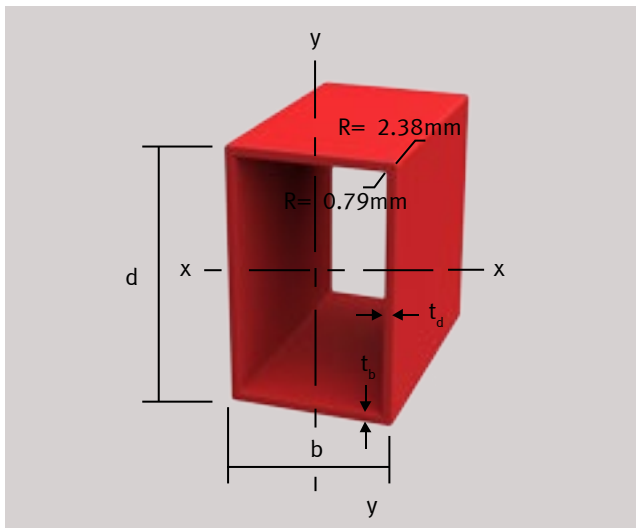

Rectangular Hollow Section		Section Dimensions			
Part	Part Number	d mm	b mm	t _d mm	t _b mm
38.1 x 19.1 x 3.2mm Rectangular Hollow Section	F-P-RHS(38/19/3.2)	38.1	19.1	3.2	3.2
38.1 x 25.4 x 3.2mm Rectangular Hollow Section	F-P-RHS(38/25/3.2)	38.1	25.4	3.2	3.2
50.8 x 25.4 x 3.2mm Rectangular Hollow Section	F-P-RHS(51/25/3.2)	50.8	25.4	3.2	3.2
101.6 x 25.4 x 3.2mm Rectangular Hollow Section	F-P-RHS(102/25/3.2)	101.6	25.4	3.2	3.2
101.6 x 3.2 x 50.8 x 6.4mm Rectangular Hollow Section	F-P-RHS(102/3.2/51/6.4)	101.6	50.8	3.2	6.4
111.1 x 3.2 x 34.9 x 4.8mm Rectangular Hollow Section	F-P-RHS(111/3.2/35/4.8)	111.13	34.93	3.2	4.8
139.7 x 88.9 x 6.4mm Rectangular Hollow Section	F-P-RHS(140/90/6.4)	139.70	88.90	6.4	6.4
152.4 x 101.6 x 6.4mm Rectangular Hollow Section	F-P-RHS(152/102/6.4)	152.40	101.60	6.4	6.4

Rectangular Hollow Section		Section Properties										
Part	Part Number	X-X				Y-Y						
		I mm ⁴	S mm ³	r mm	A _w mm ²	I mm ⁴	S mm ³	r mm	J mm ⁴	A _w mm ²	Area mm ²	Weight Kg./m
38.1 x 19.1 x 3.2mm Rectangular Hollow Section	F-P-RHS (38/19/3.2)	53925.82	2830.75	12.93	80.65	16530.02	1735.44	7.16	38424.68	202.88	322.50	0.58
38.1 x 25.4 x 3.2mm Rectangular Hollow Section	F-P-RHS (38/25/3.2)	66255.59	3477.98	13.51	120.97	33737.51	2656.50	9.64	66944.34	202.88	362.81	0.65
50.8 x 25.4 x 3.2mm Rectangular Hollow Section	F-P-RHS (51/25/3.2)	138066.35	5435.68	15.95	120.97	43993.604	3464.06	9.92	104510.35	284.16	443.44	0.80
101.6 x 25.4 x 3.2mm Rectangular Hollow Section	F-P-RHS (102/25/3.2)	848044.43	16693.79	33.27	120.97	83869.55	6603.90	10.46	251849.32	609.28	765.94	1.38
101.6 x 3.2 x 50.8 x 6.4mm Rectangular Hollow Section	F-P-RHS (102/3.2/51/6.4)	1837271.53	36166.76	38.97	564.52	459317.88	18083.38	19.49	1097485.20	609.28	1209.38	2.18
111.1 x 3.2 x 34.9 x 4.8mm Rectangular Hollow Section	F-P-RHS (111/3.2/35/4.8)	1496449.87	26932.73	39.12	272.18	196946.09	11278.23	14.19	567843.60	670.272	977.58	1.76
139.7 x 88.9 x 6.4mm Rectangular Hollow Section	F-P-RHS (140/90/6.4)	7190831.45	102946.76	51.21	967.74	3496777.55	78667.66	35.71	7128058.80	1624.32	2741.25	4.94
152.4 x 101.6 x 6.4mm Rectangular Hollow Section	F-P-RHS (152/102/6.4)	9770599.14	128223.09	56.47	1129.03	5140024.53	101181.59	40.95	10185432.86	1786.88	3063.75	5.52

Sectional Properties

Sectional Properties - Circular Hollow Section

The section values shown on this page have been calculated from the nominal dimensions of the profile. All the shapes listed in the table are available but not all are stocked. For information on availability and price, contact Treadwell Group on 1800 246 800.

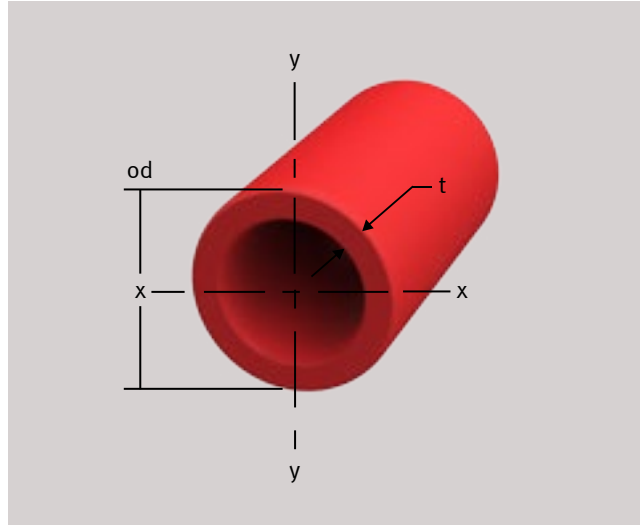

Circular Hollow Section		Section Dimensions				Section Properties		
Part	Part Number	od mm	t mm	Area mm ²	Weight Kg./m	I mm ⁴	S mm ³	r mm
		Diameter	Wall					
25.4 x 2.4mm Circular Hollow Section	F-P-CHS(25/2.4)	25.4	2.4	174.2	0.31	11586	912	8.1
25.4 x 3.2mm Circular Hollow Section	F-P-CHS(25/3.2)	25.4	3.2	219.4	0.39	14027	1105	7.9
28.6 x 3.2mm Circular Hollow Section	F-P-CHS(29/3.2)	28.6	3.2	251.6	0.45	20812	1475	9.1
31.8 x 2.4mm Circular Hollow Section	F-P-CHS(32/2.4)	31.8	2.4	219.4	0.39	24974	1516	10.4
31.8 x 3.2mm Circular Hollow Section	F-P-CHS(32/3.2)	31.8	3.2	283.9	0.51	29136	1803	10.2
31.8 x 6.4mm Circular Hollow Section	F-P-CHS(32/6.4)	31.8	6.4	509.7	0.91	41623	2786	9.1
38.1 x 3.2mm Circular Hollow Section	F-P-CHS(38/3.2)	38.1	3.2	348.4	0.62	54110	2826	12.4
38.1 x 6.4mm Circular Hollow Section	F-P-CHS(38/6.4)	38.1	6.4	632.3	1.13	83246	4425	11.4
44.5 x 3.2mm Circular Hollow Section	F-P-CHS(45/3.2)	44.5	3.2	412.9	0.74	87409	3933	14.7
44.5 x 6.4mm Circular Hollow Section	F-P-CHS(45/6.4)	44.5	6.4	761.3	1.36	141519	6391	13.7
47.6 x 4.8mm Circular Hollow Section	F-P-CHS(48/4.8)	47.6	4.8	638.7	1.14	149843	6227	15.2
50.8 x 6.4mm Circular Hollow Section	F-P-CHS(51/6.4)	50.8	6.4	883.9	1.58	224765	8849	15.7
76.2 x 6.4mm Circular Hollow Section	F-P-CHS(76/6.4)	76.2	6.4	1393.5	2.49	857437	22450	24.9
76.2 x 12.7mm Circular Hollow Section	F-P-CHS(76/12.7)	76.2	12.7	2535.5	4.54	1327778	34904	22.9

Section Properties - Solid Bars

The section values shown on this page have been calculated from the nominal dimensions of the profile. All the shapes listed in the table are available but not all are stocked. For information on availability and price, contact Treadwell Group on 1800 246 800.

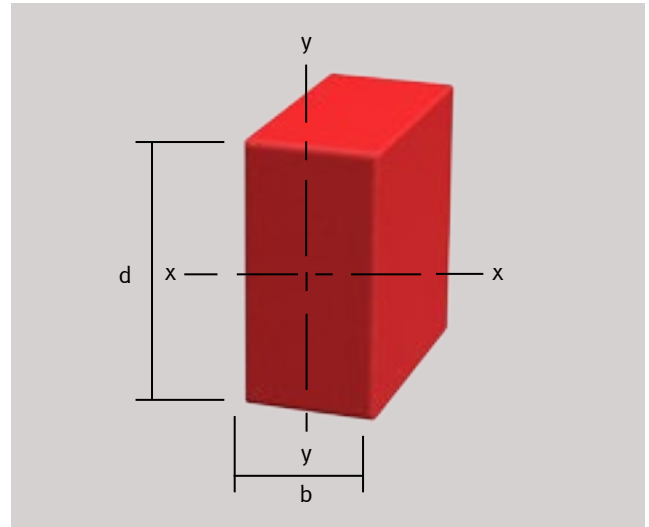

Solid Bars		Section Dimensions				Section Properties					
Part	Part Number	d mm	b mm	Area mm ²	Weight Kg./m	X-X			Y-Y		
						I mm ⁴	S mm ³	r mm	I mm ⁴	S mm ³	r mm
Square Bar											
25.4mm Square Bar	F-P-SQB(25)	25.4	25.4	645.2	1.15	33299	2786	7.4	33299	2786	7.4
31.8mm Square Bar	F-P-SQB(32)	31.8	31.8	1006.4	1.81	83246	5408	9.1	83246	5408	9.1
38.1mm Square Bar	F-P-SQB(38)	38.1	38.1	1451.6	2.60	174817	9177	10.9	174817	9177	10.9
Rectangular Bar											
19.1 x 38.1mm Rectangular Bar	F-P-REB(19/38.1)	38.1	19.05	725.81	1.31	87798.82	4608.86	11.00	21949.70	2304.43	5.50
25.4 x 38.1mm Rectangular Bar	F-P-REB(25/38.1)	38.10	25.4	967.74	1.74	117065.09	6145.15	11	52028.93	4096.77	7.33
12.7 x 50.8mm Rectangular Bar	F-P-REB(13/50.8)	50.8	12.7	645.16	1.16	138743.81	5462.35	14.66	8671.49	1365.59	3.67

Sectional Properties

Sectional Properties - Circular Round Bar

The section values shown on this page have been calculated from the nominal dimensions of the profile. All the shapes listed in the table are available but not all are stocked. For information on availability and price, contact Treadwell Group on 1800 246 800.

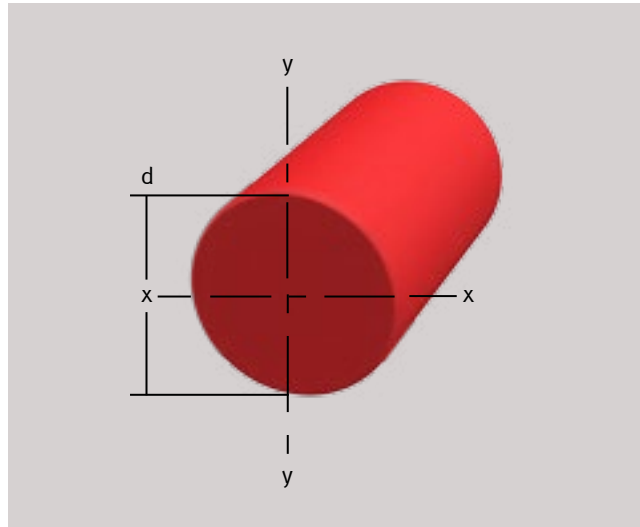

Circular Round Bar		Section Dimensions			Section Properties		
Part	Part Number	d mm	Area mm ²	Weight Kg./m	I mm ⁴	S mm ³	r mm
6.4mm Circular Round Bar	F-P-CB(6.4)	6.4	31.6	0.06	83	26	1.6
7.6mm Circular Round Bar	F-P-CB(7.6)	7.6	45.8	0.08	166	44	1.9
7.9mm Circular Round Bar	F-P-CB(7.9)	7.9	49.7	0.09	191	49	2.0
8.9mm Circular Round Bar	F-P-CB(8.9)	8.9	61.9	0.11	308	69	2.2
9.5mm Circular Round Bar	F-P-CB(9.5)	9.5	71.0	0.13	400	85	2.4
11.1mm Circular Round Bar	F-P-CB(11.1)	11.1	96.8	0.17	749	134	2.8
12mm Circular Round Bar	F-P-CB(12)	12.0	112.9	0.20	999	169	3.0
12.2mm Circular Round Bar	F-P-CB(12.2)	12.2	116.8	0.21	1082	179	3.0
12.7mm Circular Round Bar	F-P-CB(12.7)	12.7	126.5	0.23	1290	202	3.2
15.9mm Circular Round Bar	F-P-CB(15.9)	15.9	198.1	0.36	3122	393	4.0
19.1mm Circular Round Bar	F-P-CB(19.1)	19.1	285.2	0.51	6493	678	4.8
20.6mm Circular Round Bar	F-P-CB(20.6)	20.6	334.2	0.60	8907	864	5.2
22.2mm Circular Round Bar	F-P-CB(22.2)	22.2	387.7	0.69	11987	1078	5.6
25.4mm Circular Round Bar	F-P-CB(25.4)	25.4	506.5	0.91	20437	1609	6.4
31.8mm Circular Round Bar	F-P-CB(31.8)	31.8	791.6	1.42	49865	3141	7.9
38.1mm Circular Round Bar	F-P-CB(38.1)	38.1	1139.4	2.04	103434	5429	9.5

Section Properties - Embedment Angle

The section values shown on this page have been calculated from the nominal dimensions of the profile. All the shapes listed in the table are available but not all are stocked. For information on availability and price, contact Treadwell Group on 1800 246 800.

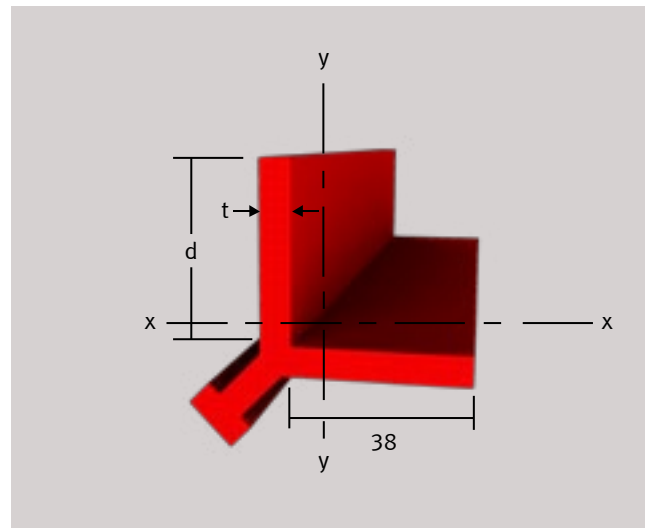

Embedment Angle		Section Dimensions				Section Properties					
Part	Part Number	d mm	t mm	Area mm ²	Weight Kg./m	X - X			Y - Y		
						I mm ⁴	S mm ³	r mm	I mm ⁴	S mm ³	r mm
25.4 x 6.4mm Embedment Angle	F-P-EA(25/6.4)	25.4	6.4	696.8	1.43	116544	4916	12.9	212278	5407	17.5
38.1 x 6.4mm Embedment Angle	F-P-EA(38/6.4)	38.1	6.4	774.2	1.64	212278	5407	16.5	212278	5407	16.5
50.8 x 6.4mm Embedment Angle	F-P-EA(51/6.4)	50.8	6.4	858.1	1.68	366283	8849	20.6	212278	5407	15.7

Sectional Properties

Sectional Properties - Square Hollow Section

The section values shown on this page have been calculated from the nominal dimensions of the profile. All the shapes listed in the table are available but not all are stocked. For information on availability and price, contact Treadwell Group on 1800 246 800.

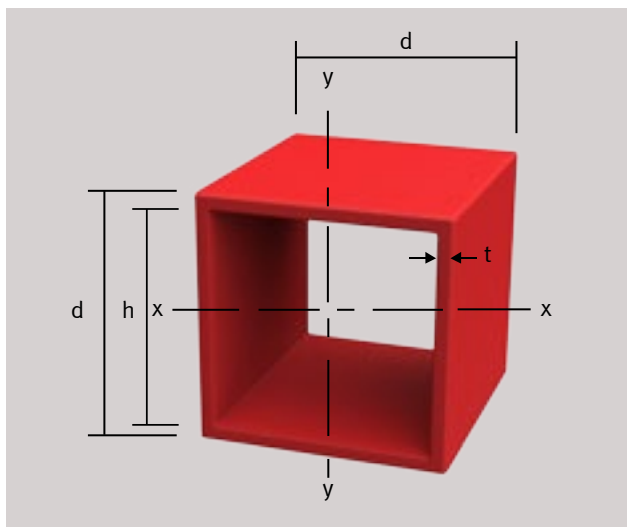

Square Hollow Section	Section Dimensions			
Part	Part Number	d mm	t mm	h mm
25.4 x 3.2mm Square Hollow Section	F-P-SHS(25/25/3.2)	25.4	3.2	19.05
25.4 x 6.4mm Square Hollow Section	F-P-SHS(25/25/6.4)	25.4	6.4	12.70
31.8 x 3.2mm Square Hollow Section	F-P-SHS(32/32/3.2)	31.8	3.2	25.40
31.8 x 6.4mm Square Hollow Section	F-P-SHS(32/32/6.4)	31.8	6.4	19.05
38.1 x 3.2mm Square Hollow Section	F-P-SHS(38/38/3.2)	38.1	3.2	31.75
38.1 x 6.4mm Square Hollow Section	F-P-SHS(38/38/6.4)	38.1	6.4	25.40
44.5 x 3.2mm Square Hollow Section	F-P-SHS(45/45/3.2)	44.5	3.2	38.10
44.5 x 6.4mm Square Hollow Section	F-P-SHS(45/45/6.4)	44.5	6.4	31.75
50.8 x 3.2mm Square Hollow Section	F-P-SHS(51/51/3.2)	50.8	3.2	44.45
50.8 x 6.4mm Square Hollow Section	F-P-SHS(51/51/6.4)	50.8	6.4	38.10
50.8 x 9.5mm Square Hollow Section	F-P-SHS(51/51/9.5)	50.8	9.5	31.75
57.2 x 3.2mm Square Hollow Section	F-P-SHS(57/57/3.2)	57.2	3.2	50.80
76.2 x 3.2mm Square Hollow Section	F-P-SHS(76/76/3.2)	76.2	3.2	69.85
76.2 x 6.4mm Square Hollow Section	F-P-SHS(76/76/6.4)	76.2	6.4	63.50
88.9 x 6.4mm Square Hollow Section	F-P-SHS(89/89/6.4)	88.9	6.4	76.20
101.6 x 6.4mm Square Hollow Section	F-P-SHS(102/102/6.4)	101.6	6.4	89.90
101.6 x 8mm Square Hollow Section	F-P-SHS(102/102/8)	101.6	8	85.6
101.6 x 9.5mm Square Hollow Section	F-P-SHS(102/102/9.5)	101.6	9.5	82.55
127 x 8mm Square Hollow Section	F-P-SHS(127/127/8)	127	8	111
152.4 x 9.5mm Square Hollow Section	F-P-SHS(152/152/9.5)	152.4	9.5	133.35

Square Hollow Section	Section Properties							
Part	Part Number	I mm ⁴	S mm ³	r mm	J mm ⁴	A _w mm ²	Area mm ²	Weight Kg./m
25.4 x 3.2mm Square Hollow Section	F-P-SHS(25/25/3.2)	23711.08	1867.01	9.17	36151.4	120.94	282.19	0.51
25.4 x 6.4mm Square Hollow Section	F-P-SHS(25/25/6.4)	32518.05	2560.47	8.20	51052.7	161.25	483.75	0.87
31.8 x 3.2mm Square Hollow Section	F-P-SHS(32/32/3.2)	49996.50	3149.38	11.74	81776.5	161.25	362.81	0.65
31.8 x 6.4mm Square Hollow Section	F-P-SHS(32/32/6.4)	73707.57	4642.98	10.69	124615	241.88	645.00	1.16
38.1 x 3.2mm Square Hollow Section	F-P-SHS(38/38/3.2)	90915.04	4772.43	14.32	142846	201.56	443.44	0.80
38.1 x 6.4mm Square Hollow Section	F-P-SHS(38/38/6.4)	140911.54	7396.91	13.22	227439	322.5	806.25	1.45
44.5 x 3.2mm Square Hollow Section	F-P-SHS(45/45/3.2)	149718.51	6736.47	16.90	245581	241.88	524.06	0.94
44.5 x 6.4mm Square Hollow Section	F-P-SHS(45/45/6.4)	240633.55	10827.13	15.77	405671	403.13	967.5	1.74
50.8 x 3.2mm Square Hollow Section	F-P-SHS(51/51/3.2)	229658.71	9041.66	19.49	365396	282.19	604.69	1.09
50.8 x 6.4mm Square Hollow Section	F-P-SHS(51/51/6.4)	379377.21	14936.07	18.33	618023	483.75	1128.75	2.03
50.8 x 9.5mm Square Hollow Section	F-P-SHS(51/51/9.5)	470292.25	18515.39	17.29	781349	604.69	1572.19	2.83
57.2 x 3.2mm Square Hollow Section	F-P-SHS(57/57/3.2)	333987.44	11688.07	22.07	518919	322.5	685.31	1.23
76.2 x 3.2mm Square Hollow Section	F-P-SHS(76/76/3.2)	825822.90	21675.08	29.84	1270000	443.44	927.19	1.67
76.2 x 6.4mm Square Hollow Section	F-P-SHS(76/76/6.4)	1454640.63	38179.43	28.63	2290000	806.25	1773.75	3.20
88.9 x 6.4mm Square Hollow Section	F-P-SHS(89/89/6.4)	2395496.12	53891.77	33.80	3790000	967.5	2096.25	3.78
101.6 x 6.4mm Square Hollow Section	F-P-SHS(102/102/6.4)	3674539.30	72333.24	38.97	5850000	1128.75	2418.75	4.36
101.6 x 8mm Square Hollow Section	F-P-SHS(102/102/8)	4405420.03	86720.87	38.35	7010000	1369.6	2995.2	5.32
101.6 x 9.5mm Square Hollow Section	F-P-SHS(102/102/9.5)	5009811.60	98618.05	37.79	8010000	1572.19	3507.19	6.32
127 x 8mm Square Hollow Section	F-P-SHS(127/127/8)	9028133.33	142175.33	48.69	14100000	1776	3808	6.48
152.4 x 9.5mm Square Hollow Section	F-P-SHS(152/152/9.5)	18602355.19	244124.69	58.46	28700000	2539.69	5442.19	9.81

Beams - Allowable Uniforms Loads

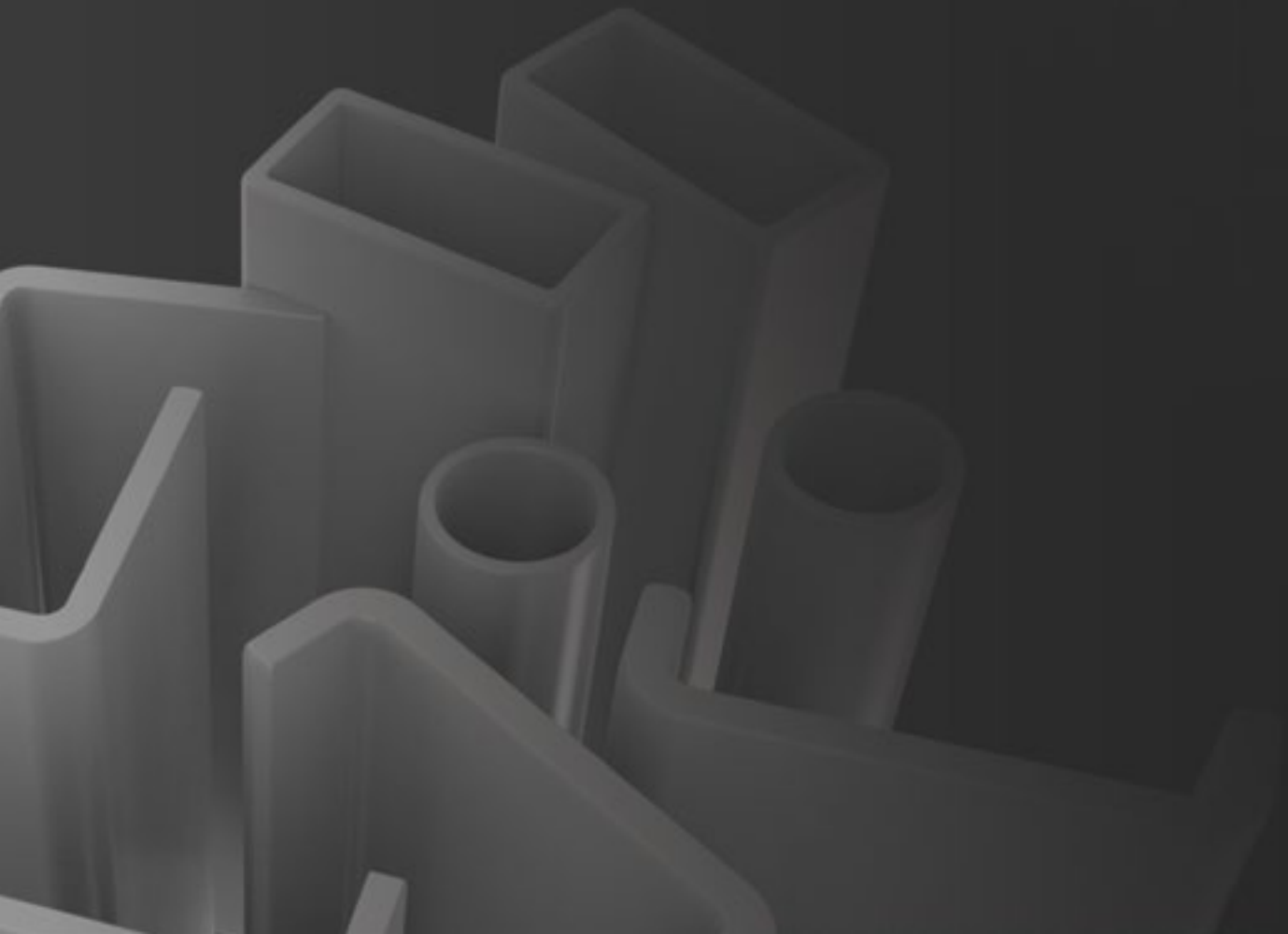

Beams - Allowable Uniform Loads

Allowable Uniform Load Tables

Full section 3-point bending tests were conducted on Treadwell Reinforced Plastics' H-Beams, I-Beams, C Section and Square Hollow Section. The allowable uniform load tables were generated using these tests results as well as the formulas, properties, and assumptions listed below. Formulas for critical buckling and lateral-torsional buckling developed from theory are presented in Chapter 6 and 7 of the ASCE Structural Plastics Design Manual.

Notation	
A_w	area of web (in. ² / mm. ²)
b	flange width (in. / mm.)
b_c	C Section flange minus thickness (in. / mm.)
b_h	1/2 of flange width (in. / mm.)
d	depth of section (in. / mm.)
E	modulus of elasticity (lbs. / in. ² / GPa)
f_b	actual flexural stress (lbs. / in. ² / MPa)
F_b	maximum allowable flexural stress (lbs. / in. ² / MPa)
F_{aCB}	maximum allowable buckling stress (lbs. / in. ² / MPa)
F_{aLTB}	maximum allowable lateral-torsional buckling stress (lbs. / in. ² / MPa)
f_v	actual shear stress (lbs. / in. ² / MPa)
F_v	maximum allowable shear stress (lbs. / in. ² / MPa)
G	shear modulus (lbs. / in. ² / GPa)
I	moment of inertia (in. ⁴ / mm. ⁴)
J	torsion constant (in. ⁴ / mm. ⁴)
L	length of span (in. / mm.)
M	maximum moment (lbs.-in. / N.-m.)
S_x	section modulus (in. ³ / mm. ³)
t	flange thickness (in. / mm.)
V	vertical shear force (lbs. / N.)
w	uniform load (lbs./in. / N/m.)
ν_t	poission's ratio (longitudinal)
ν_r	poission's ratio (transverse)

Assumptions

- Beam simply supported at both ends
- Uniformly distributed load
- Load is applied perpendicular to major axis
- Part weight has been deducted in tables
- Safety factor of 3.0 for both ultimate material flexural and shear stress and 2.5 for buckling stresses

Beams - Allowable Uniform Loads

Properties / Allowables	Formulas
$E = 2.8 \times 10^6 \text{ lbs./in.}^2$ $E = 19.3 \text{ GPa}$	$\Delta = \frac{5wL^4}{384EI} + \frac{wL^2}{8A_w G}$
$G = 450,000 \text{ lbs. /in.}^2$ $G = 3.1 \text{ GPa}$	$f_b = \frac{M}{S_x}$
$F_b = 10,000 \text{ lbs./in}^2$ $F_b = 68.9 \text{ MPa}$	
$F_v = 1500 \text{ lbs./in}^2$ $F_v = 10.3 \text{ MPa}$	$f_v = \frac{V}{A_w}$

Allowable Critical Buckling Stress for laterally supported WF and I Beams

$$F_{aCB} = \frac{\pi^2}{b_h^2 t} \left[.935 \sqrt{\left(\frac{Et^3}{12\lambda}\right)\left(\frac{V_T Et^3}{12\lambda}\right)} - (.656)\left(\frac{V_T Et^3}{12\lambda}\right) + (2.082)\left(\frac{Gt^3}{12}\right) \right] / 2.5$$

$$\lambda = (1 - V_L V_T)$$

Allowable Lateral-Torsional Buckling Stress for laterally unsupported WF and I Beams

$$F_{aLTB} = \left[\frac{C \pi}{S(KL)} \sqrt{E I_y GJ + \frac{d^2 \pi^2 E^2 I_y^2}{(4)(KL)^2}} \right] / 2.5$$

C = 1.13 and K = 1.0 for uniform load simple beam*

Allowable Critical Buckling Stress for C Sections laterally supported to eliminate warping and twist

$$F_{aCB} = G(t/b_c)^2 / 2.5$$

Allowable Bending Stress for Square Tube (b/t <=16)

$$F_b = 10,000 \text{ psi.}$$

C Section

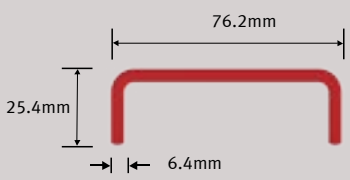

Beams - Allowable Uniform Loads

Part: 76.2 x 25.4 x 6.4mm C Section							
Part Number: F-P-CS(76/25/6.4)							
			A_w	403.2mm ²	Wt.	1.18kg/m	
			I	528614mm ⁴	S	13929mm ³	
Span (m)	Maximum Load (N/m)		Deflection (N/m)				
			L/100	L/150	L/180	L/240	L/360
0.91	9110	F_v	8622	5744	4785	3586	2387
1.22	5157	F_b	3901	2597	2162	1619	1075
1.52	3296	F_b	2063	1371	1141	853	565
1.83	2286	F_b	1213	805	669	498	328
2.13	1676	F_b	769	509	422	314	205
2.44	1281	F_b	515	340	281	208	135
2.74	1009	F_b	360	236	195	143	92
3.05	815	F_b	261	170	140	102	64
The part weight has been deducted in the above table.							

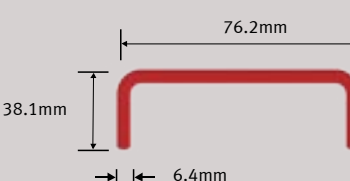
Part: 76.2 x 38.1 x 6.4mm C Section							
Part Number: F-P-CS(76/38/6.4)							
			A_w	403.2mm ²	Wt.	1.50kg/m	
			I	728405mm ⁴	S	19009mm ³	
Span (m)	Maximum Load (N/m)		Deflection (N/m)				
			L/100	L/150	L/180	L/240	L/360
0.91	8999	F_v	----	7456	6208	4649	3090
1.22	5049	F_v	----	3440	2862	2139	1416
1.52	3221	F_b	2763	1832	1522	1134	746
1.83	2228	F_b	1629	1077	892	662	432
2.13	1629	F_b	1032	679	561	413	266
2.44	1240	F_b	690	450	370	270	170
2.74	974	F_b	479	310	253	183	112
3.05	783	F_b	340	219	178	126	74
The part weight has been deducted in the above table.							

Beams - Allowable Uniform Loads

Part: 88.9 x 38.1 x 4.8mm C Section

Part Number: F-P-CS(89/38/4.8)

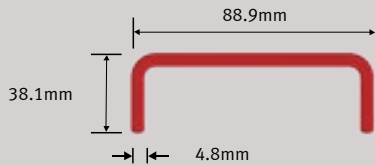

A_w	348.3mm ²	Wt.	1.28kg/m
I	799164mm ⁴	S	18026mm ³

Span (m)	Maximum Load (N/m)		Deflection (N/m)				
			L/100	L/150	L/180	L/240	L/360
0.91	4353	F_v	----	----	----	----	3228
1.22	2442	F_v	----	----	----	2286	1519
1.52	1558	F_b	----	----	----	1233	817
1.83	1077	F_b	----	----	980	731	483
2.13	788	F_b	----	753	625	465	305
2.44	600	F_b	----	506	419	311	202
2.74	471	F_b	----	355	293	216	139
3.05	378	F_b	----	256	211	155	98
3.35	310	F_b	292	190	156	113	71
3.66	258	F_b	223	144	117	84	51

The part weight has been deducted in the above table.

Part: 88.9 x 38.1 x 6.4mm C Section

Part Number: F-P-CS(89/38/6.4)

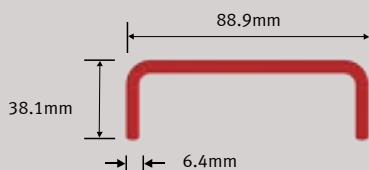

A_w	483.8mm ²	Wt.	1.74kg/m
I	994793mm ⁴	S	22450mm ³

Span (m)	Maximum Load (N/m)		Deflection (N/m)				
			L/100	L/150	L/180	L/240	L/360
3	727	F_b	----	680	566	425	283
4	409	F_b	----	318	265	198	132
5	261	F_b	257	171	142	106	71
6	181	F_b	153	101	84	63	42
7	133	F_b	98	65	54	40	26
8	101	F_b	66	43	36	27	17
9	80	F_b	46	30	25	19	12

The part weight has been deducted in the above table.

Beams - Allowable Uniform Loads

Part: 101.6 x 28.6 x 6.4mm C Section

Part Number: F-P-CS(102/29/6.4)

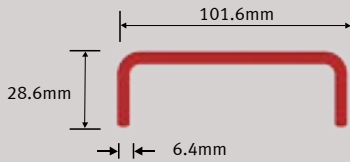

A_w	564.5mm ²	Wt.	1.56kg/m
I	1194584mm ⁴	S	23597mm ³

Span (m)	Maximum Load (N/m)		Deflection (N/m)				
			L/100	L/150	L/180	L/240	L/360
0.91	12755	F_v	----	11843	9867	7396	4926
1.22	7767	F_b	----	5553	4625	3465	2305
1.52	4965	F_b	4497	2993	2492	1865	1238
1.83	3444	F_b	2677	1779	1480	1106	733
2.13	2526	F_b	1712	1136	944	705	465
2.44	1930	F_b	1156	766	636	473	310
2.74	1522	F_b	815	538	446	331	215
3.05	1230	F_b	594	391	323	238	154

The part weight has been deducted in the above table.

Part: 101.6 x 34.9 x 4.8mm C Section

Part Number: F-P-CS(102/35/4.8)

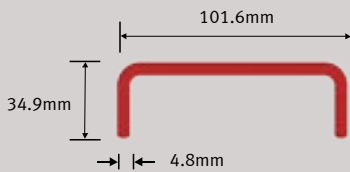

A_w	438.7mm ²	Wt.	1.31kg/m
I	1090526mm ⁴	S	21467mm ³

Span (m)	Maximum Load (N/m)		Deflection (N/m)				
			L/100	L/150	L/180	L/240	L/360
0.91	6343	F_v	----	----	----	----	4322
1.22	3562	F_v	----	----	----	3086	2053
1.52	2275	F_b	----	----	2237	1675	1112
1.83	1576	F_b	----	----	1336	999	662
2.13	1154	F_b	----	1029	855	638	421
2.44	881	F_b	----	695	577	430	282
2.74	693	F_b	----	490	406	301	196
3.05	559	F_b	540	356	295	218	141

The part weight has been deducted in the above table.

Beams - Allowable Uniform Loads

Part: 139.7 x 38.1 x 6.4mm C Section							
Part Number: F-P-CS(140/38/6.4)							
			A_w	846.7mm ²	Wt.	2.22kg/m	
			I	3071788mm ⁴	S	43917mm ³	
Major Axis (N/m)							
Span (m)	Maximum Load (N/m)		Deflection (N/m)				
			L/100	L/150	L/180	L/240	L/360
0.91	19127	F_v	----	----	----	16318	10869
1.22	11722	F_v	----	----	10781	8078	5376
1.52	7491	F_b	----	7200	5995	4489	2983
1.83	5193	F_b	----	4365	3633	2717	1802
2.13	3808	F_b	----	2825	2349	1755	1160
2.44	2908	F_b	2899	1923	1597	1191	784
2.74	2292	F_b	2057	1362	1130	840	550
3.05	1851	F_b	1507	995	825	611	398
3.35	1525	F_b	1134	746	617	456	294
3.66	1276	F_b	872	572	472	346	221
3.96	1083	F_b	683	446	367	268	169
4.27	930	F_b	543	352	289	209	130
4.57	806	F_b	438	282	230	165	100
Minor Axis (N/m)							
A_w	361.2mm ²			Wt.	2.22 kg/m		
I	133194mm ⁴			S	4752mm ³		
Span (m)	Maximum Load (N/m)		Deflection (N/m)				
			L/100	L/150	L/180	L/240	L/360
0.91	3073	F_b	2425	1607	1334	993	652
1.22	1716	F_b	1029	676	559	412	265
1.52	1088	F_b	518	336	275	199	123
1.83	746	F_b	289	183	148	104	59
The part weight has been deducted in the above table.							

Beams - Allowable Uniform Loads

Part: 152.4 x 41.3 x 6.4mm C Section

Part Number: F-P-CS(152/41/6.4)

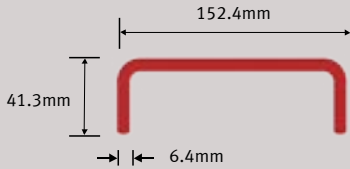

A_w	887.1mm ²	Wt.	2.49kg/m	
I	4237236mm ⁴	S	5552mm ³	

Span (m)	Maximum Load (N/m)		Deflection (N/m)				
			L/100	L/150	L/180	L/240	L/360
1.52	7820	F _v	----	----	----	5908	3929
1.83	5422	F _b	----	----	4845	3627	2408
2.13	3976	F _b	----	3803	3164	2366	1567
2.44	3037	F _b	----	2607	2167	1618	1069
2.74	2394	F _b	----	1857	1542	1149	757
3.05	1933	F _b	----	1364	1132	842	551
3.35	1593	F _b	1557	1028	852	632	411
3.66	1334	F _b	1202	792	655	484	313
3.96	1132	F _b	945	620	512	377	241
4.27	972	F _b	755	493	406	297	189
4.57	843	F _b	611	397	326	237	149

The part weight has been deducted in the above table.

Part: 152.4 x 42.9 x 9.5mm C Section

Part Number: F-P-CS(152/43/9.5)

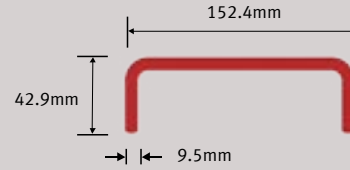

A_w	1270.3mm ²	Wt.	3.87kg/m	
I	6056167mm ⁴	S	79477mm ³	

Span (m)	Maximum Load (N/m)		Deflection (N/m)				
			L/100	L/150	L/180	L/240	L/360
1.52	17199	F _v	----	13538	11274	8445	5615
1.83	13063	F _b	12500	8319	6925	5183	3441
2.13	9586	F _b	8173	5434	4521	3380	2239
2.44	7329	F _b	5608	3724	3096	2311	1526
2.74	5782	F _b	4000	2652	2203	1641	1079
3.05	4675	F _b	2944	1948	1616	1201	786
3.35	3856	F _b	2224	1468	1216	901	586
3.66	3233	F _b	1716	1130	934	690	445
3.96	2748	F _b	1349	885	730	537	343
4.27	2364	F _b	1077	703	579	423	267
4.57	2053	F _b	871	566	464	337	210

The part weight has been deducted in the above table.

Beams - Allowable Uniform Loads

Part: 203.2 x 55.6 x 9.5mm C Section

Part Number: F-P-CS(203/56/9.5)

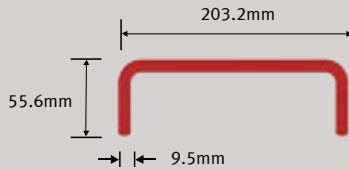

A_w

1754mm²

Wt.

4.76kg/m

I

14888598mm⁴

S

146500mm³

Span (m)	Maximum Load (N/m)		Deflection (N/m)				
			L/100	L/150	L/180	L/240	L/360
1.52	23752	F_v	----	----	----	18030	12001
1.83	18545	F_v	----	18405	15327	11481	7634
2.13	13610	F_v	----	12333	10268	7686	5105
2.44	10406	F_b	----	8613	7168	5361	3555
2.74	8210	F_b	----	6224	5177	3868	2559
3.05	6639	F_b	----	4627	3846	2870	1894
3.35	5477	F_b	5314	3523	2926	2180	1434
3.66	4593	F_b	4135	2737	2271	1689	1106
3.96	3905	F_b	3275	2164	1793	1330	867
4.27	3359	F_b	2633	1736	1437	1063	689
4.57	2918	F_b	2145	1410	1165	860	554
4.88	2558	F_b	1767	1159	956	702	449
5.18	2259	F_b	1471	961	791	579	366
5.49	2009	F_b	1235	804	660	480	301
5.79	1797	F_b	1045	677	555	401	248
6.10	1616	F_b	890	574	469	337	205

The part weight has been deducted in the above table.

Beams - Allowable Uniform Loads

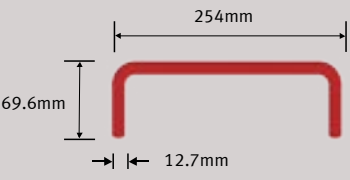
Part: 254 x 69.6 x 12.7mm C Section							
Part Number: F-P-CS(254/70/12.7)							
			A_w	2903.2mm ²	Wt.	7.89kg/m	
			I	38497245mm ⁴	S	303161mm ³	
Span (m)	Maximum Load (N/m)		Deflection (N/m)				
			L/100	L/150	L/180	L/240	L/360
1.83	27278	F_v	----	----	----	26298	17503
2.13	23369	F_v	----	----	----	18077	12022
2.44	20437	F_v	----	----	17183	12865	8548
2.74	18156	F_v	----	15140	12602	9430	6257
3.05	15910	F_b	----	11393	9479	7088	4696
3.35	13133	F_b	----	8762	7287	5443	3600
3.66	11022	F_b	10347	6866	5707	4258	2810
3.96	9378	F_b	8246	5468	4542	3385	2227
4.27	8074	F_b	6670	4418	3667	2728	1790
4.57	7022	F_b	5464	3614	2997	2226	1455
4.88	6161	F_b	4526	2988	2476	1835	1194
5.18	5448	F_b	3787	2495	2065	1527	989
5.49	4850	F_b	3196	2101	1737	1281	825
5.79	4344	F_b	2719	1783	1471	1082	692
6.10	3912	F_b	2329	1523	1255	919	584
6.40	3540	F_b	2008	1309	1077	786	495
6.71	3218	F_b	1741	1132	928	674	420
7.01	2936	F_b	1517	982	804	581	358
7.32	2690	F_b	1329	857	699	503	306
7.62	2472	F_b	1168	750	610	436	261

The part weight has been deducted in the above table.

Beams - Allowable Uniform Loads

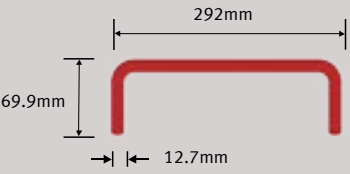
Part: 292 x 69.9 x 12.7mm C Section							
Part Number: F-P-CS(292/70/12.7)							
			A_w	3387.1mm ²	Wt.	9.04kg/m	
			I	51862436mm ⁴	S	315007mm ³	
Span (m)	Maximum Load (N/m)		Deflection (N/m)				
			L/100	L/150	L/180	L/240	L/360
1.83	31822	F_v	----	----	----	----	22472
2.13	27261	F_v	----	----	----	23429	15585
2.44	23841	F_v	----	----	22430	16797	11164
2.74	21181	F_v	----	19875	16545	12383	8222
3.05	18635	F_b	----	15023	12502	9351	6200
3.35	15383	F_b	----	11596	9646	7209	4772
3.66	12910	F_b	----	9114	7578	5658	3738
3.96	10985	F_b	10968	7278	6048	4510	2973
4.27	9458	F_b	8891	5893	4894	3645	2396
4.57	8225	F_b	7296	4830	4008	2981	1953
4.88	7217	F_b	6054	4002	3318	2463	1608
5.18	6381	F_b	5072	3348	2773	2054	1335
5.49	5681	F_b	4287	2824	2336	1727	1117
5.79	5088	F_b	3652	2401	1984	1462	941
6.10	4582	F_b	3133	2055	1695	1246	796
6.40	4147	F_b	2705	1769	1457	1067	678
6.71	3769	F_b	2348	1532	1259	919	579
7.01	3440	F_b	2050	1332	1093	794	496
7.32	3151	F_b	1797	1164	953	689	425
7.62	2896	F_b	1583	1021	834	600	366

The part weight has been deducted in the above table.

Beams - Allowable Uniform Loads

Part: 304.8 x 76.2 x 12.7mm C Section							
Part Number: F-P-CS(305/76/12.7)							
			A_w	3548.4mm ²	Wt.	9.68kg/m	
			I	59729209mm ⁴	S	391651mm ³	
Span (m)	Maximum Load (N/m)		Deflection (N/m)				
			L/100	L/150	L/180	L/240	L/360
1.83	33342	F_v	----	----	----	----	25014
2.13	28564	F_v	----	----	----	26248	17465
2.44	24981	F_v	----	----	----	18916	12577
2.74	20565	F_v	----	----	18705	14003	9301
3.05	16638	F_v	----	----	14181	10610	7039
3.35	13733	F_v	----	13185	10971	8202	5434
3.66	11523	F_b	----	10387	8639	6453	4268
3.96	9803	F_b	----	8310	6908	5156	3403
4.27	8439	F_b	----	6740	5600	4174	2749
4.57	7338	F_b	----	5533	4594	3420	2246
4.88	6437	F_b	----	4591	3809	2831	1853
5.18	5690	F_b	----	3846	3188	2365	1543
5.49	5065	F_b	4924	3249	2690	1992	1294
5.79	4535	F_b	4199	2766	2288	1690	1093
6.10	4083	F_b	3606	2370	1958	1443	928

The part weight has been deducted in the above table.

Beams - Allowable Uniform Loads

Part: 355.6x88.9x19.1mm C Section

Part Number: F-P-CS(356/89/19)

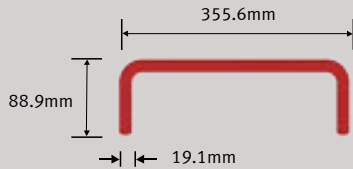

A_w	9435.465mm ²	Wt.	16.7421kg/m
I	146822384mm ⁴	S	825772.688mm ³

Span (m)	Maximum Load (N/m)		Deflection (N/m)				
			L/100	L/150	L/180	L/240	L/360
0.91	506160	F _b	---	547160	455967	341975	227983
1.22	284715	F _b	---	330598	275498	206624	137749
1.52	182217	F _b	317391	211594	176329	132246	88164
1.83	126540	F _b	212548	141699	118082	88562	59041
2.13	92968	F _b	147865	98576	82147	61610	41073
2.44	71179	F _b	106280	70854	59045	44283	29522
2.74	56240	F _b	78572	52381	43651	32738	21826
3.05	45554	F _b	59519	39679	33066	24800	16533
3.35	37648	F _b	46050	30700	25583	19188	12792
3.66	31635	F _b	36293	24195	20163	15122	10081
3.96	26955	F _b	29070	19380	16150	12113	8075
4.27	23242	F _b	23620	15746	13122	9841	6561
4.57	20246	F _b	19436	12957	10798	8098	5399
4.88	17795	F _b	16174	10783	8986	6739	4493
5.18	15763	F _b	13597	9065	7554	5666	3777
5.49	14060	F _b	11535	7690	6409	4806	3204
5.79	12619	F _b	9867	6578	5482	4111	2741
6.10	11389	F _b	8503	5669	4724	3543	2362
6.40	10330	F _b	7378	4919	4099	3074	2049
6.71	9412	F _b	6442	4295	3579	2684	1789
7.01	8611	F _b	5657	3771	3143	2357	1571
7.32	7909	F _b	4994	3329	2774	2081	1387
7.62	7289	F _b	4430	2953	2461	1846	1230
7.92	6739	F _b	3947	2631	2193	1645	1096

The part weight has been deducted in the above table.

I-Beam



Beams - Allowable Uniform Loads

Part: 76.2 x 38.1 x 6.4mm I-Beam

Part Number: F-P-IS(76/38/6.4)

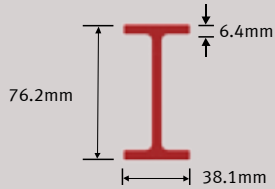

A_w	403.2mm ²	Wt.	1.64kg/m
I	728405mm ⁴	S	19173mm ³

Span (m)	No Lateral Support	Maximum Load (N/m)		Deflection (N/m)				
	Max. Load (N/m)			L/100	L/150	L/180	L/240	L/360
1.22	1488	6825	F_v	5188	3453	2875	2152	1429
1.52	724	4537	F_b	2776	1845	1535	1147	759
1.83	403	3146	F_b	1643	1090	905	675	445
2.13	244	2307	F_b	1046	692	574	426	279
2.44	156	1762	F_b	703	463	383	283	184
2.74	104	1389	F_b	493	323	266	196	125
3.05	71	1122	F_b	357	232	191	139	87

The part weight has been deducted in the above table.

Part: 88.9 x 38.1 x 4.7mm I-Beam

Part Number: F-P-IS(89/38/4.7)

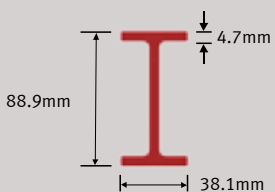

A_w	377.4mm ²	Wt.	1.31kg/m
I	836625mm ⁴	S	18845mm ³

Span (m)	No Lateral Support	Maximum Load (N/m)		Deflection (N/m)				
	Max. Load (N/m)			L/100	L/150	L/180	L/240	L/360
1.22	984	6388	F_b	5795	3858	3213	2406	1599
1.52	461	4460	F_b	3131	2083	1733	1296	859
1.83	249	3093	F_b	1865	1238	1029	768	507
2.13	146	2269	F_b	1192	790	656	488	321
2.44	91	1733	F_b	804	531	440	327	213
2.74	59	1367	F_b	566	372	308	227	147
3.05	38	1104	F_b	411	269	222	163	104

The part weight has been deducted in the above table.

Beams - Allowable Uniform Loads

Part: 101.6 x 50.8 x 6.4mm I-Beam								
Part Number: F-P-IS(102/51/6.4)								
				A_w	564.5mm ²	Wt.	2.23kg/m	
				I	1835581mm ⁴	S	36215mm ³	
Span (m)	No Lateral Support	Maximum Load (N/m)		Deflection (N/m)				
	Max. Load (N/m)			L/100	L/150	L/180	L/240	L/360
1.22	3265	9555	F_v	----	7915	6592	4939	3285
1.52	1514	7640	F_v	6565	4369	3638	2723	1808
1.83	817	5950	F_b	3965	2636	2193	1639	1085
2.13	486	4366	F_b	2560	1699	1412	1054	695
2.44	310	3337	F_b	1740	1153	957	712	468
2.74	207	2632	F_b	1232	814	675	500	326
3.05	142	2128	F_b	901	593	491	362	234
3.35	100	1755	F_b	676	443	366	269	172
3.66	71	1471	F_b	519	338	278	203	128
The part weight has been deducted in the above table.								

Part: 139.7 x 63.5 x 6.4mm I-Beam								
Part Number: F-P-IS(140/64/6.4)								
				A_w	806mm ²	Wt.	2.86kg/m	
				I	4665954mm ⁴	S	66859.00mm ³	
Span (m)	No Lateral Support	Maximum Load (N/m)		Deflection (N/m)				
	Max. Load (N/m)			L/100	L/150	L/180	L/240	L/360
1.22	7034	13654	F_v	----	----	----	10829	7210
1.52	3874	10917	F_v	----	10013	8340	6248	4156
1.83	2010	9093	F_v	----	6221	5179	3878	2576
2.13	1164	7262	F_b	6156	4094	3407	2549	1690
2.44	728	5554	F_b	4247	2822	2347	1753	1159
2.74	482	4382	F_b	3041	2018	1677	1251	825
3.05	332	3544	F_b	2246	1488	1235	919	604
3.35	236	2924	F_b	1701	1125	933	692	452
3.66	171	2453	F_b	1316	868	719	532	345
3.96	126	2086	F_b	1037	682	564	416	268
4.27	94	1795	F_b	830	544	449	329	210
4.57	70	1560	F_b	673	439	361	264	167
The part weight has been deducted in the above table.								

Beams - Allowable Uniform Loads

Part: 152.4 x 76.2 x 6.4mm I-Beam

Part Number: F-P-IS(152/76/6.4)

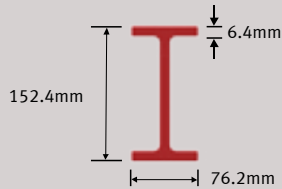

A_w	887.1mm ²	Wt.	3.27kg/m
I	7071772mm ⁴	S	92751mm ³

Span (m)	No Lateral Support Max. Load (N/m)	Maximum Load (N/m)		Deflection (N/m)				
				L/100	L/150	L/180	L/240	L/360
1.52	5307	12008	F_v	----	----	11083	8304	5525
1.83	2689	10001	F_v	----	8400	6995	5238	3481
2.13	1524	8568	F_v	8403	5591	4654	3483	2311
2.44	936	7493	F_v	5844	3885	3232	2416	1600
2.74	610	6321	F_v	4211	2796	2325	1736	1146
3.05	415	5114	F_b	3124	2072	1721	1283	845
3.35	292	4221	F_b	2376	1573	1306	971	637
3.66	210	3542	F_b	1845	1219	1011	750	489
3.96	154	3013	F_b	1458	961	796	589	382
4.27	114	2594	F_b	1170	769	636	469	302
4.57	84	2255	F_b	951	623	514	377	241

The part weight has been deducted in the above table.

Part: 152.4 x 76.2 x 9.5mm I-Beam

Part Number: F-P-IS(152/76/9.5)

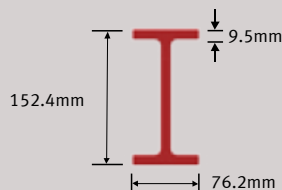

A_w	1270mm ²	Wt.	4.76kg/m
I	9302772mm ⁴	S	122084mm ³

Span (m)	No Lateral Support Max. Load (N/m)	Maximum Load (N/m)		Deflection (N/m)				
				L/100	L/150	L/180	L/240	L/360
1.52	9256	17195	F_v	----	----	15678	11747	7816
1.83	4860	14321	F_v	----	11870	9884	7401	4918
2.13	2847	12268	F_v	11865	7894	6571	4916	3262
2.44	1801	10729	F_v	8246	5482	4561	3409	2257
2.74	1206	8901	F_b	5939	3944	3279	2447	1616
3.05	842	7201	F_b	4405	2921	2426	1808	1190
3.35	607	5943	F_b	3349	2217	1840	1368	896
3.66	449	4986	F_b	2599	1717	1423	1056	688
3.96	338	4242	F_b	2053	1353	1120	828	537
4.27	258	3651	F_b	1647	1082	894	659	424
4.57	199	3174	F_b	1339	877	723	530	338
4.88	154	2784	F_b	1100	718	591	431	272
5.18	120	2461	F_b	913	593	487	353	220
5.49	93	2190	F_b	765	494	404	291	179

The part weight has been deducted in the above table.

Beams - Allowable Uniform Loads

Part: 203.2 x 101.6 x 9.5mm I-Beam

Part Number: F-P-IS(203/102/9.5)

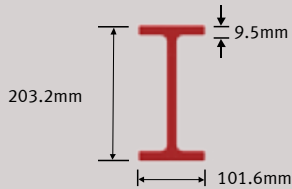

A_w	1754mm ²	Wt.	6.4kg/m
I	23121656mm ⁴	S	227616mm ³

Span (m)	No Lateral Support	Maximum Load (N/m)		Deflection (N/m)				
	Max. Load (N/m)			L/100	L/150	L/180	L/240	L/360
1.22	29698	29698	F _v	----	----	----	----	25452
1.52	23746	23746	F _v	----	----	----	----	15970
1.83	12217	19778	F _v	----	----	----	15815	10522
2.13	6880	16943	F _v	----	----	14506	10864	7222
2.44	4210	14818	F _v	----	12400	10323	7727	5130
2.74	2741	13164	F _v	----	9093	7567	5659	3752
3.05	1872	11841	F _v	10289	6838	5688	4250	2813
3.35	1327	10759	F _v	7915	5256	4370	3261	2153
3.66	969	9321	F _b	6205	4116	3420	2549	1678
3.96	724	7933	F _b	4945	3276	2720	2024	1328
4.27	551	6831	F _b	3998	2644	2193	1629	1065
4.57	426	5943	F _b	3273	2161	1790	1327	864
4.88	332	5216	F _b	2709	1785	1477	1092	707
5.18	261	4613	F _b	2265	1489	1230	907	584
5.49	206	4108	F _b	1910	1252	1033	759	485
5.79	163	3680	F _b	1623	1061	874	640	406
6.10	129	3315	F _b	1389	905	744	542	341

The part weight has been deducted in the above table.

Beams - Allowable Uniform Loads

Part: 203.2 x 101.6 x 12.7mm I-Beam

Part Number: F-P-IS(203/102/12.7)

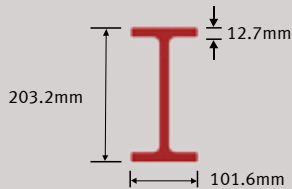

A_w

2258mm²

Wt.

8.48kg/m

I

29394263mm⁴

S

289396mm³

Span (m)	No Lateral Support	Maximum Load (N/m)		Deflection (N/m)				
	Max. Load (N/m)			L/100	L/150	L/180	L/240	L/360
1.83	17993	25456	F _v	----	----	----	20182	13427
2.13	10346	21808	F _v	----	----	18497	13852	9207
2.44	6455	19071	F _v	----	15802	13154	9845	6536
2.74	4280	16943	F _v	----	11581	9637	7207	4777
3.05	2972	15240	F _v	13101	8706	7241	5410	3579
3.35	2140	13847	F _v	10075	6689	5560	4149	2738
3.66	1586	11847	F _b	7896	5236	4350	3241	2133
3.96	1203	10083	F _b	6291	4166	3458	2573	1687
4.27	929	8682	F _b	5084	3362	2788	2070	1352
4.57	728	7552	F _b	4161	2746	2275	1685	1096
4.88	577	6628	F _b	3444	2268	1876	1386	896
5.18	462	5862	F _b	2878	1891	1562	1151	739
5.49	372	5219	F _b	2426	1590	1311	962	614
5.79	301	4676	F _b	2061	1346	1108	810	512
6.10	244	4212	F _b	1763	1148	943	686	430

The part weight has been deducted in the above table.

Beams - Allowable Uniform Loads

Part: 254 x 127 x 9.5mm I-Beam

Part Number: F-P-IS(254/127/9.5)

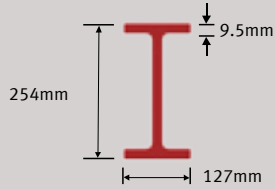

A_w	2237mm ²	Wt.	8.6kg/m
I	46463914mm ⁴	S	365923mm ³

Span (m)	No Lateral Support	Maximum Load (N/m)		Deflection (N/m)				
	Max. Load (N/m)			L/100	L/150	L/180	L/240	L/360
2.13	15066	21613	F _v	----	----	----	19046	12669
2.44	9026	18900	F _v	----	----	18543	13886	9229
2.74	5761	16791	F _v	----	16652	13860	10374	6888
3.05	3863	15104	F _v	----	12717	10583	7916	5249
3.35	2694	13723	F _v	----	9898	8235	6155	4075
3.66	1939	12572	F _v	11793	7834	6514	4864	3215
3.96	1432	11599	F _v	9478	6291	5228	3900	2572
4.27	1080	10764	F _v	7719	5118	4251	3167	2083
4.57	828	9570	F _b	6359	4211	3496	2601	1706
4.88	644	8401	F _b	5294	3501	2904	2157	1410
5.18	506	7432	F _b	4449	2938	2434	1804	1175
5.49	401	6620	F _b	3770	2485	2057	1521	986
5.79	319	5933	F _b	3218	2117	1750	1292	833
6.10	255	5346	F _b	2766	1816	1499	1103	708
6.40	203	4842	F _b	2393	1567	1292	948	604
6.71	162	4404	F _b	2081	1359	1119	818	517
7.01	128	4022	F _b	1819	1185	973	709	444
7.32	100	3687	F _b	1598	1037	850	616	383
7.62	77	3391	F _b	1409	911	745	538	330

The part weight has been deducted in the above table.

Beams - Allowable Uniform Loads

Part: 254 x 127 x 12.7mm I-Beam

Part Number: F-P-IS(254/127/12.7)

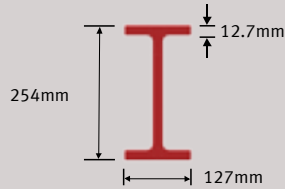

A_w

2903mm²

Wt.

10.71kg/m

I

59641801mm⁴

S

469653mm³

Span (m)	No Lateral Support	Maximum Load (N/m)		Deflection (N/m)				
	Max. Load (N/m)			L/100	L/150	L/180	L/240	L/360
2.13	21472	28040	F_v	----	----	----	24542	16326
2.44	13050	24522	F_v	----	----	23879	17883	11887
2.74	8452	21786	F_v	----	21429	17840	13354	8868
3.05	5752	19597	F_v	----	16363	13618	10188	6757
3.35	4070	17806	F_v	----	12733	10594	7919	5244
3.66	2973	16313	F_v	15165	10075	8378	6258	4137
3.96	2228	15050	F_v	12187	8090	6724	5017	3309
4.27	1705	13968	F_v	9924	6581	5466	4074	2681
4.57	1327	12287	F_b	8175	5415	4495	3345	2195
4.88	1048	10786	F_b	6806	4502	3734	2774	1815
5.18	837	9542	F_b	5719	3777	3130	2322	1513
5.49	675	8500	F_b	4846	3196	2645	1958	1270
5.79	548	7618	F_b	4137	2723	2252	1663	1073
6.10	448	6865	F_b	3557	2336	1929	1421	912
6.40	367	6217	F_b	3076	2016	1662	1221	779
6.71	301	5656	F_b	2676	1749	1440	1054	667
7.01	247	5165	F_b	2339	1525	1253	913	574
7.32	202	4735	F_b	2055	1335	1095	795	495
7.62	165	4356	F_b	1812	1173	960	694	428

The part weight has been deducted in the above table.

Beams - Allowable Uniform Loads

Part: 304.8 x 152.4 x 12.7mm I-Beam								
Part Number: F-P-IS(305/152/12.7)								
				A_w	3548mm ²	Wt.	12.95kg/m	
				I	105706133mm ⁴	S	693664mm ³	
Span (m)	No Lateral Support	Maximum Load (N/m)		Deflection (N/m)				
	Max. Load (N/m)			L/100	L/150	L/180	L/240	L/360
2.13	34273	34273	F _v	----	----	----	----	25029
2.44	24706	29973	F _v	----	----	----	28049	18657
2.74	15757	26629	F _v	----	----	----	21350	14191
3.05	10567	23953	F _v	----	----	22105	16547	10989
3.35	7377	21764	F _v	----	20929	17420	13033	8646
3.66	5322	19940	F _v	----	16739	13928	10414	6901
3.96	3945	18396	F _v	----	13564	11282	8430	5578
4.27	2990	17073	F _v	16746	11121	9247	6903	4560
4.57	2310	15926	F _v	13886	9215	7658	5712	3766
4.88	1812	14923	F _v	11627	7709	6403	4770	3138
5.18	1441	14038	F _v	9820	6504	5399	4018	2636
5.49	1159	12583	F _b	8360	5531	4588	3409	2230
5.79	940	11280	F _b	7168	4736	3926	2913	1899
6.10	768	10168	F _b	6187	4082	3381	2504	1627
6.40	631	9211	F _b	5372	3539	2928	2164	1400
6.71	521	8381	F _b	4690	3084	2549	1880	1211
7.01	431	7658	F _b	4115	2701	2230	1640	1051
7.32	357	7022	F _b	3627	2376	1959	1437	916
7.62	296	6462	F _b	3211	2098	1727	1264	800
7.92	245	5965	F _b	2853	1860	1529	1115	701
8.23	201	5522	F _b	2545	1654	1357	986	615
8.53	165	5126	F _b	2277	1476	1208	875	541
8.84	133	4770	F _b	2044	1320	1079	777	476
9.14	106	4449	F _b	1839	1184	965	692	419

The part weight has been deducted in the above table.

Beams - Allowable Uniform Loads

Part: 457.2 x 9.5 x 114.3 x 12.7mm I-Beam

Part Number: F-P-IS(457/9.5/114/12.7)

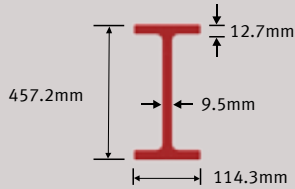

A_w	4112mm ²	Wt.	12.95kg/m
I	207345685mm ⁴	S	907024mm ³

Span (m)	No Lateral Support Max. Load (N/m)	Maximum Load (N/m)		Deflection (N/m)				
				L/100	L/150	L/180	L/240	L/360
1.83	41793	46391	F _v	----	----	----	----	44253
2.13	22848	39746	F _v	----	----	----	----	33580
2.44	13571	34762	F _v	----	----	----	----	25940
2.74	8585	30885	F _v	----	----	----	30585	20348
3.05	5705	27784	F _v	----	----	----	24334	16180
3.35	3942	25247	F _v	----	----	----	19601	13025
3.66	2810	23132	F _v	----	----	21333	15968	10603
3.96	2055	21343	F _v	----	21106	17567	13143	8720
4.27	1535	19809	F _v	----	17750	14604	10921	7239
4.57	1165	18480	F _v	----	14723	12248	9154	6060
4.88	896	17317	F _v	----	12451	10354	7734	5114
5.18	696	16291	F _v	15975	10608	8818	6582	4346
5.49	545	15379	F _v	13712	9099	7562	5639	3717
5.79	428	14563	F _v	11846	7855	6524	4862	3199
6.10	337	13335	F _b	10293	6820	5662	4215	2768
6.40	264	12083	F _b	8993	5953	4940	3673	2406
6.71	206	10998	F _b	7897	5222	4331	3216	2102
7.01	159	10052	F _b	6967	4602	3814	2829	1843
7.32	121	9221	F _b	6173	4073	3373	2498	1623
7.62	89	8488	F _b	5491	3619	2994	2214	1434
7.92	62	7838	F _b	4904	3227	2668	1969	1270
8.23	39	7259	F _b	4394	2887	2385	1757	1129
8.53	20	6741	F _b	3950	2591	2138	1572	1006
8.84	----	6276	F _b	3562	2332	1922	1410	898
9.14	----	5856	F _b	3221	2105	1733	1268	803

The part weight has been deducted in the above table.

Beams - Allowable Uniform Loads

Part: 609.6 x 9.5 x 190.5 x 19.1mm I-Beam

Part Number: F-P-IS(610/9.5/191/19)

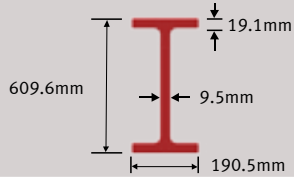

A_w	5445mm ²	Wt.	22.62kg/m
I	781266386mm ⁴	S	2563265mm ³

Span (m)	No Lateral Support Max. Load (N/m)	Maximum Load (N/m)		Deflection (N/m)				
				L/100	L/150	L/180	L/240	L/360
3.05	36730	36730	F _v	----	----	----	----	35335
3.35	33371	33371	F _v	----	----	----	----	29887
3.66	24071	30571	F _v	----	----	----	----	25450
3.96	17569	28203	F _v	----	----	----	----	21804
4.27	13127	26172	F _v	----	----	----	----	18782
4.57	10006	24413	F _v	----	----	----	----	16262
4.88	7760	22873	F _v	----	----	----	21330	14146
5.18	6108	21514	F _v	----	----	----	18651	12360
5.49	4870	20307	F _v	----	----	----	16378	10844
5.79	3926	19226	F _v	----	----	----	14439	9552
6.10	3196	18254	F _v	----	----	17111	12778	8445
6.40	2624	17374	F _v	----	----	15205	11348	7492
6.71	2170	16574	F _v	----	16314	13558	10113	6668
7.01	1806	15844	F _v	----	14598	12128	9041	5953
7.32	1511	15174	F _v	----	13104	10883	8107	5331

The part weight has been deducted in the above table.

Part: 609.6 x 9.5 x 190.5 x 19.1mm I-Beam

Part Number: F-P-IS(610/9.5/191/19)

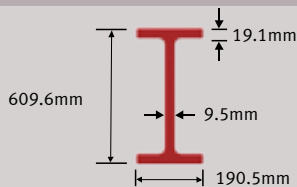

A_w	5445mm ²	Wt.	22.62kg/m
I	781266386mm ⁴	S	2563265mm ³

Span (m)	No Lateral Support Max. Load (N/m)	Maximum Load (N/m)		Deflection (N/m)				
				L/100	L/150	L/180	L/240	L/360
7.62	1269	14559	F _v	----	11798	9794	7290	4786
7.92	1069	13990	F _v	----	10651	8839	6574	4309
8.23	903	13464	F _v	----	9641	7997	5943	3888
8.53	764	12975	F _v	----	8749	7254	5385	3516
8.84	647	12520	F _v	12049	7959	6596	4891	3187
9.14	547	12095	F _v	10996	7256	6010	4452	2894
9.45	462	11698	F _v	10056	6630	5488	4061	2633
9.75	389	11326	F _v	9216	6070	5022	3711	2400
10.06	325	10976	F _v	8463	5568	4603	3397	2191
10.36	271	10646	F _v	7787	5117	4227	3115	2003
10.67	223	10336	F _v	7177	4711	3889	2861	1834
10.97	181	10043	F _v	6627	4344	3583	2632	1681
11.28	144	9765	F _v	6129	4012	3306	2424	1542
11.58	112	9502	F _v	5677	3711	3055	2236	1417
11.89	83	9253	F _v	5267	3437	2827	2065	1303
12.19	58	9016	F _v	4893	3188	2620	1909	1199

The part weight has been deducted in the above table.



WF-Beam

Beams - Allowable Uniform Loads

Part: 76.2 x 76.2 x 6.4mm WF-Beam

Part Number: F-P-WF(76/76/6.4)

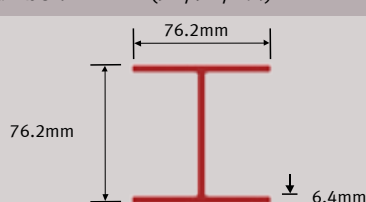

A_w	403.2mm ²	Wt.	2.44kg/m
I	1319454mm ⁴	S	34577mm ³

Span (m)	No Lateral Support	Maximum Load (N/m)		Deflection (N/m)				
	Max. Load (N/m)			L/100	L/150	L/180	L/240	L/360
1.22	6817	6817	F_v	----	5674	4724	3537	2350
1.52	3278	5449	F_v	4707	3130	2604	1947	1290
1.83	1741	4537	F_v	2840	1885	1567	1169	772
2.13	1028	3885	F_v	1831	1213	1007	749	491
2.44	654	3183	F_b	1242	820	679	504	328
2.74	439	2510	F_b	877	577	477	351	226
3.05	306	2029	F_b	639	418	344	252	160

The part weight has been deducted in the above table.

Part: 101.6 x 101.6 x 6.4mm WF-Beam

Part Number: F-P-WF(102/102/6.4)

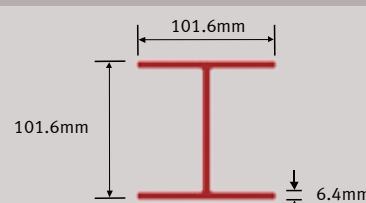

A_w	564.5mm ²	Wt.	3.20kg/m
I	3304878mm ⁴	S	65057mm ³

Span (m)	No Lateral Support	Maximum Load (N/m)		Deflection (N/m)				
	Max. Load (N/m)			L/100	L/150	L/180	L/240	L/360
1.22	9546	9546	F_v	----	----	----	7630	5076
1.52	7630	7630	F_v	----	7062	5879	4402	2924
1.83	4219	6353	F_v	----	4386	3650	2729	1809
2.13	2396	5441	F_v	4342	2884	2398	1791	1183
2.44	1477	4757	F_v	2993	1985	1649	1229	809
2.74	967	4156	F_b	2140	1417	1175	874	572
3.05	663	3360	F_b	1578	1041	863	639	416
3.35	471	2772	F_b	1193	785	649	479	309
3.66	344	2324	F_b	920	603	497	365	233
3.96	256	1976	F_b	723	471	388	283	178
4.27	194	1699	F_b	576	373	306	222	137
4.57	149	1476	F_b	465	299	244	175	106

The part weight has been deducted in the above table.

Beams - Allowable Uniform Loads

Part: 152.4 x 152.4 x 6.4mm WF-Beam

Part Number: F-P-WF(152/152/6.4)

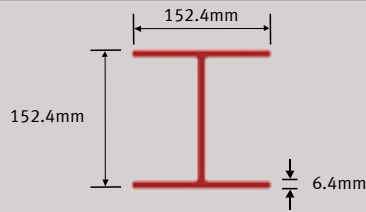

A_w	887.1mm ²	Wt.	5.06kg/m
I	11771025mm ⁴	S	154530mm ³

Span (m)	No Lateral Support	Maximum Load (N/m)		Deflection (N/m)				
	Max. Load (N/m)			L/100	L/150	L/180	L/240	L/360
1.52	11990	11990	F_v	----	----	----	----	8091
1.83	9896	9896	F_b	----	----	----	8016	5328
2.13	7258	7258	F_b	----	----	----	5504	3652
2.44	5545	5545	F_b	----	----	5230	3910	2590
2.74	3790	4371	F_b	----	----	3830	2860	1890
3.05	2522	3531	F_b	----	3460	2875	2144	1413
3.35	1746	2909	F_b	----	2656	2205	1641	1078
3.66	1248	2437	F_b	----	2076	1722	1279	836
3.96	915	2069	F_b	----	1649	1366	1012	658
4.27	685	1777	F_b	----	1328	1098	811	524
4.57	522	1542	F_b	----	1082	893	658	422

The part weight has been deducted in the above table.

Part: 152.4 x 152.4 x 9.5mm WF-Beam

Part Number: F-P-WF(152/152/9.5)

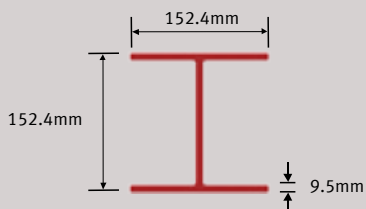

A_w	1270mm ²	Wt.	7.29kg/m
I	16720016mm ⁴	S	219423mm ³

Span (m)	No Lateral Support	Maximum Load (N/m)		Deflection (N/m)				
	Max. Load (N/m)			L/100	L/150	L/180	L/240	L/360
1.22	21480	21480	F_v	----	----	----	----	18393
1.52	17170	17170	F_v	----	----	----	----	11529
1.83	14296	14296	F_v	----	----	----	11415	7586
2.13	12244	12244	F_v	----	----	10468	7833	5198
2.44	9783	10704	F_v	----	8943	7441	5563	3685
2.74	6306	9507	F_v	----	6551	5447	4067	2688
3.05	4272	8549	F_v	7416	4920	4088	3048	2008
3.35	3011	7765	F_v	5699	3775	3134	2333	1531
3.66	2191	7112	F_v	4462	2951	2447	1817	1188
3.96	1636	6560	F_v	3550	2343	1941	1438	935
4.27	1249	5765	F_b	2865	1886	1560	1152	744
4.57	970	5013	F_b	2341	1537	1269	934	599

The part weight has been deducted in the above table.

Beams - Allowable Uniform Loads

Part: 203.2 x 203.2 x 9.5mm WF-Beam								
Part Number: F-P-WF(203/203/9.5)								
				A_w	1754mm ²	Wt.	9.66kg/m	
				I	41285995mm ⁴	S	406399mm ³	
Span (m)	No Lateral Support	Maximum Load (N/m)		Deflection (N/m)				
	Max. Load (N/m)			L/100	L/150	L/180	L/240	L/360
1.22	29666	29666	F_v	----	----	----	----	----
1.52	23714	23714	F_v	----	----	----	----	21636
1.83	19746	19746	F_v	----	----	----	----	15008
2.13	16911	16911	F_v	----	----	----	16139	10727
2.44	14786	14786	F_v	----	----	----	11849	7868
2.74	13132	13132	F_v	----	----	11898	8900	5902
3.05	11716	11810	F_v	----	10968	9125	6820	4515
3.35	8108	9755	F_b	----	8566	7123	5318	3514
3.66	5800	8182	F_b	----	6797	5648	4212	2777
3.96	4265	6958	F_b	----	5469	4541	3382	2223
4.27	3210	5986	F_b	----	4455	3696	2749	1801
4.57	2463	5202	F_b	----	3669	3042	2258	1474
4.88	1922	4561	F_b	----	3052	2527	1872	1216
5.18	1521	4029	F_b	3888	2561	2118	1565	1012
5.49	1219	3584	F_b	3295	2165	1789	1318	847
5.79	986	3207	F_b	2813	1844	1521	1117	713
6.10	805	2885	F_b	2417	1580	1301	952	603

The part weight has been deducted in the above table.

Beams - Allowable Uniform Loads

Part: 203.2 x 203.2 x 12.7mm WF-Beam

Part Number: F-P-WF(203/203/12.7)

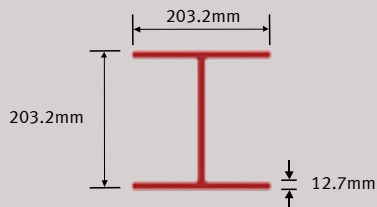

A_w

2258mm²

Wt.

12.95kg/m

I

52844742mm⁴

S

520125mm³

Span (m)	No Lateral Support	Maximum Load (N/m)		Deflection (N/m)				
	Max. Load (N/m)			L/100	L/150	L/180	L/240	L/360
1.83	25412	25412	F _v	----	----	----	----	19254
2.13	21764	21764	F _v	----	----	----	20696	13755
2.44	19028	19028	F _v	----	----	----	15189	10083
2.74	16899	16899	F _v	----	----	15247	11404	7560
3.05	15197	15197	F _v	----	14052	11689	8735	5781
3.35	11596	13804	F _v	----	10972	9122	6810	4497
3.66	8378	12643	F _v	----	8703	7231	5391	3552
3.96	6222	11660	F _v	10563	7000	5812	4327	2843
4.27	4730	10818	F _v	8614	5701	4729	3515	2301
4.57	3667	10089	F _v	7104	4694	3890	2886	1882
4.88	2890	9450	F _v	5918	3903	3231	2392	1552
5.18	2311	8887	F _v	4974	3273	2707	1998	1290
5.49	1870	8242	F _b	4214	2767	2285	1682	1079
5.79	1529	7385	F _b	3597	2355	1942	1425	907
6.10	1262	6652	F _b	3090	2017	1660	1213	767
6.40	1049	6022	F _b	2670	1738	1427	1038	650
6.71	878	5476	F _b	2319	1504	1232	892	553
7.01	738	4999	F _b	2025	1308	1068	770	471
7.32	623	4581	F _b	1775	1141	930	666	401
7.62	528	4212	F _b	1563	999	812	577	342

The part weight has been deducted in the above table.

Beams - Allowable Uniform Loads

Part: 254 x 254 x 9.5mm WF-Beam

Part Number: F-P-WF(254/254/9.5)

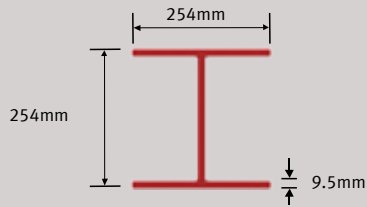

A_w	2237mm ²	Wt.	13.01kg/m
I	82634425mm ⁴	S	650730mm ³

Span (m)	No Lateral Support Max. Load (N/m)	Maximum Load (N/m)		Deflection (N/m)				
				L/100	L/150	L/180	L/240	L/360
2.13	21569	21569	F _v	----	----	----	----	17668
2.44	18857	18857	F _v	----	----	----	----	13349
2.74	14953	14953	F _b	----	----	----	----	10266
3.05	12088	12088	F _b	----	----	----	----	8022
3.35	9968	9968	F _b	----	----	----	9600	6357
3.66	8355	8355	F _b	----	----	----	7718	5103
3.96	7100	7100	F _b	----	----	----	6278	4143
4.27	6105	6105	F _b	----	----	----	5161	3398
4.57	5301	5301	F _b	----	----	----	4283	2813
4.88	4288	4644	F _b	----	----	----	3585	2348
5.18	3375	4099	F _b	----	----	4075	3024	1974
5.49	2690	3643	F _b	----	----	3467	2569	1670
5.79	2169	3256	F _b	----	----	2970	2195	1421
6.10	1765	2926	F _b	----	----	2558	1887	1215
6.40	1448	2642	F _b	----	----	2216	1630	1044
6.71	1197	2396	F _b	----	2339	1928	1414	900
7.01	996	2182	F _b	----	2048	1685	1232	779
7.32	832	1993	F _b	----	1800	1479	1077	676
7.62	698	1827	F _b	----	1588	1302	945	587

The part weight has been deducted in the above table.

Beams - Allowable Uniform Loads

Part: 254 x 254 x 12.7mm WF-Beam								
Part Number: F-P-WF(254/254/12.7)								
				A_w	2903mm ²	Wt.	16.22kg/m	
				I	106638491mm ⁴	S	839673mm ³	
Span (m)	No Lateral Support	Maximum Load (N/m)		Deflection (N/m)				
	Max. Load (N/m)			L/100	L/150	L/180	L/240	L/360
2.13	27986	27986	F _v	----	----	----	----	22865
2.44	24468	24468	F _v	----	----	----	----	17270
2.74	21732	21732	F _v	----	----	----	19999	13280
3.05	19543	19543	F _v	----	----	----	15642	10375
3.35	17752	17752	F _v	----	----	16603	12413	8222
3.66	16259	16259	F _v	----	16062	13358	9979	6600
3.96	13552	14996	F _v	----	13083	10876	8117	5358
4.27	10190	13914	F _v	----	10772	8950	6673	4396
4.57	7819	12294	F _b	----	8956	7437	5538	3639
4.88	6105	10786	F _b	----	7513	6234	4636	3038
5.18	4839	9536	F _b	----	6353	5268	3911	2554
5.49	3886	8489	F _b	8197	5411	4483	3323	2162
5.79	3157	7603	F _b	7039	4640	3840	2840	1841
6.10	2591	6846	F _b	6083	4002	3309	2442	1575
6.40	2145	6195	F _b	5287	3471	2866	2110	1354
6.71	1789	5630	F _b	4618	3026	2495	1832	1168
7.01	1502	5138	F _b	4054	2650	2181	1596	1011
7.32	1268	4705	F _b	3574	2330	1915	1396	878
7.62	1076	4324	F _b	3163	2056	1687	1225	764
7.92	917	3986	F _b	2810	1820	1491	1078	666
8.23	783	3684	F _b	2505	1617	1321	951	581
8.53	671	3415	F _b	2240	1440	1174	841	507
8.84	576	3173	F _b	2009	1286	1045	744	443
9.14	495	2954	F _b	1806	1151	933	660	387

The part weight has been deducted in the above table.

Beams - Allowable Uniform Loads

Part: 304.8 x 304.8 x 12.7mm WF-Beam								
Part Number: F-P-WF(305/305/12.7)								
				A_w	3548mm ²	Wt.	19.64kg/m	
				I	188323909mm ⁴	S	1236404mm ³	
Span (m)	No Lateral Support	Maximum Load (N/m)		Deflection (N/m)				
	Max. Load (N/m)			L/100	L/150	L/180	L/240	L/360
2.13	34207	34207	F_v	----	----	----	----	33180
2.44	29907	29907	F_v	----	----	----	----	25696
2.74	26563	26563	F_v	----	----	----	----	20199
3.05	23887	23887	F_v	----	----	----	----	16087
3.35	21698	21698	F_v	----	----	----	19544	12965
3.66	19702	19702	F_b	----	----	----	15938	10561
3.96	16759	16759	F_b	----	----	----	13128	8688
4.27	14424	14424	F_b	----	----	----	10913	7211
4.57	12540	12540	F_b	----	----	12261	9148	6034
4.88	10998	10998	F_b	----	----	10367	7727	5087
5.18	9363	9720	F_b	----	----	8827	6572	4317
5.49	7485	8649	F_b	----	----	7566	5626	3687
5.79	6055	7743	F_b	----	----	6524	4845	3166
6.10	4950	6969	F_b	----	6827	5657	4194	2732
6.40	4084	6304	F_b	----	5654	4930	3649	2369
6.71	3398	5726	F_b	----	5218	4316	3189	2062
7.01	2847	5223	F_b	----	4593	3795	2798	1801
7.32	2401	4781	F_b	----	4059	3350	2465	1579
7.62	2036	4391	F_b	----	3600	2968	2178	1388
7.92	1736	4045	F_b	----	3205	2638	1931	1223
8.23	1486	3737	F_b	----	2861	2352	1716	1080
8.53	1277	3461	F_b	----	2562	2103	1529	955
8.84	1100	3214	F_b	----	2300	1885	1366	846
9.14	951	2990	F_b	----	2070	1693	1222	750
9.45	823	2788	F_b	----	1868	1524	1095	666
9.75	713	2605	F_b	----	1688	1375	983	591
10.06	619	2438	F_b	2389	1529	1242	883	525
10.36	537	2286	F_b	2176	1387	1123	794	465
10.67	465	2146	F_b	1986	1260	1018	715	412

The part weight has been deducted in the above table.

A 3D architectural rendering of a double web beam structure. The structure is composed of multiple parallel beams with internal webs, shown in a perspective view. The beams are light gray, and the background is a dark gray gradient. The text "Double Web Beam" is overlaid on the right side of the image in a red, sans-serif font.

Double Web Beam

Beams - Allowable Uniform Loads

Part: 225 x 475 x 10 x 16mm Double Web Beam

Part Number: F-P-DWB(225/475/10/16)

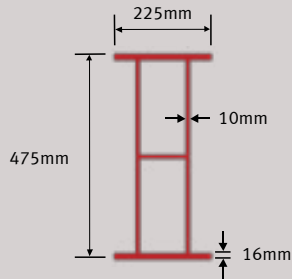

A_w	8900mm ²	Wt.	28.9kg/m
I	524000000mm ⁴	S	2210000mm ³

Span (m)	Maximum Load (N/m)		Deflection (N/m)				
			L/100	L/150	L/180	L/240	L/360
4.27	50659	----	----	----	----	21276	----
4.57	46085	----	----	----	----	17689	----
4.88	41934	----	----	----	----	14768	----
5.18	38393	----	----	----	18772	12514	----
5.49	35155	----	----	21272	15954	10636	----
5.79	32374	----	----	21973	18310	13733	9155
6.10	29812	----	----	18953	15794	11846	7897
6.40	27597	----	----	16530	13775	10331	6888
6.71	25546	----	----	14437	12031	9023	6016
7.01	23760	----	19099	12733	10611	7958	5303
7.32	20638	----	15010	10007	8339	6254	4169
7.62	19315	----	13420	8947	7456	5592	3728
7.92	18072	----	12003	8002	6668	5001	3334
8.23	16976	----	10814	7209	6008	4506	3004
8.53	15941	----	9744	6496	5413	4060	2707
8.84	15024	----	8838	5892	4910	3683	2455
9.14	14155	----	8016	5344	4453	3340	2227
9.45	13382	----	7313	4876	4063	3047	2032
9.75	12645	----	6671	4447	3706	2780	1853
10.06	11987	----	6119	4079	3399	2550	1700
10.36	11359	----	5610	3740	3117	2338	1558

The part weight has been deducted in the above table.



Rectangular Hollow Section

Beams - Allowable Uniform Loads

Part: 101.6 x 3.2 x 50.8 x 6.4mm Rectangular Hollow Section

Part Number: F-P-RHS(102/3.2/51/6.4)

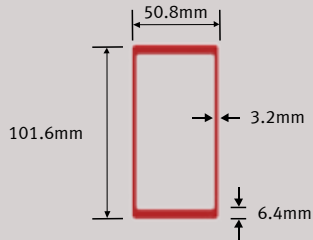

A_w	283mm ²	Wt.	2.17kg/m
I	1823093mm ⁴	S	35887mm ³

Span (m)	Maximum Load (N/m)		Deflection (N/m)				
			L/100	L/150	L/180	L/240	L/360
1.52	3824	F _v	----	3794	3167	2364	1562
1.83	3181	F _b	----	2364	1970	1474	963
2.13	2729	F _b	2350	1562	1299	963	628
2.44	2379	F _b	1620	1065	890	657	423
2.74	2116	F _b	1153	759	628	467	306
3.05	1897	F _b	846	555	467	336	219
3.35	1722	F _b	642	423	350	248	161
3.66	1445	F _b	496	321	263	190	117

The part weight has been deducted in the above table.

Beams - Allowable Uniform Loads

Part: 152.4 x 101.6 x 6.4mm Rectangular Hollow Section

Part Number: F-P-RHS(152/102/6.4)

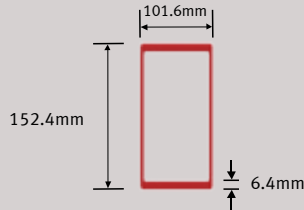

A_w	1561mm ²	Wt.	5.66kg/m
I	9527537mm ⁴	S	125033mm ³

Major Axis (N/m)

Span (m)	Maximum Load (N/m)		Deflection (N/m)				
			L/100	L/150	L/180	L/240	L/360
1.83	14652	F_v	----	12580	10478	7837	5210
2.13	15076	F_b	12478	8304	6903	5166	3430
2.44	11544	F_b	8625	5721	4758	3561	2350
2.74	9107	F_b	6173	4101	3400	2539	1678
3.05	7370	F_b	4568	3021	2510	1868	1226
3.35	6071	F_b	3459	2291	1897	1401	919
3.66	5093	F_b	2685	1766	1459	1080	701
3.96	4334	F_b	2116	1386	1153	846	540
4.27	3721	F_b	1693	1109	919	671	423
4.57	3240	F_b	1372	890	730	540	336
4.88	2846	F_b	1124	730	598	438	263

Minor Axis (N/m)

A_w	993mm ²	Wt.	5.66 kg/m
I	5032237mm ⁴	S	99141mm ³

Span (m)	Maximum Load (N/m)		Deflection (N/m)				
			L/100	L/150	L/180	L/240	L/360
1.83	9311	F_v	----	6830	5677	4247	2817
2.13	7968	F_v	6728	4466	3707	2773	1824
2.44	6961	F_v	4612	3050	2539	1883	1240
2.74	6188	F_v	3284	2175	1795	1343	876
3.05	5560	F_v	2423	1591	1313	978	628
3.35	4801	F_b	1824	1197	992	730	467
3.66	4028	F_b	1401	919	759	555	350
3.96	3430	F_b	1095	715	584	423	263
4.27	2948	F_b	876	555	452	336	204
4.57	2554	F_b	701	452	365	263	146
4.88	2247	F_b	569	365	292	204	117

The part weight has been deducted in the above table.

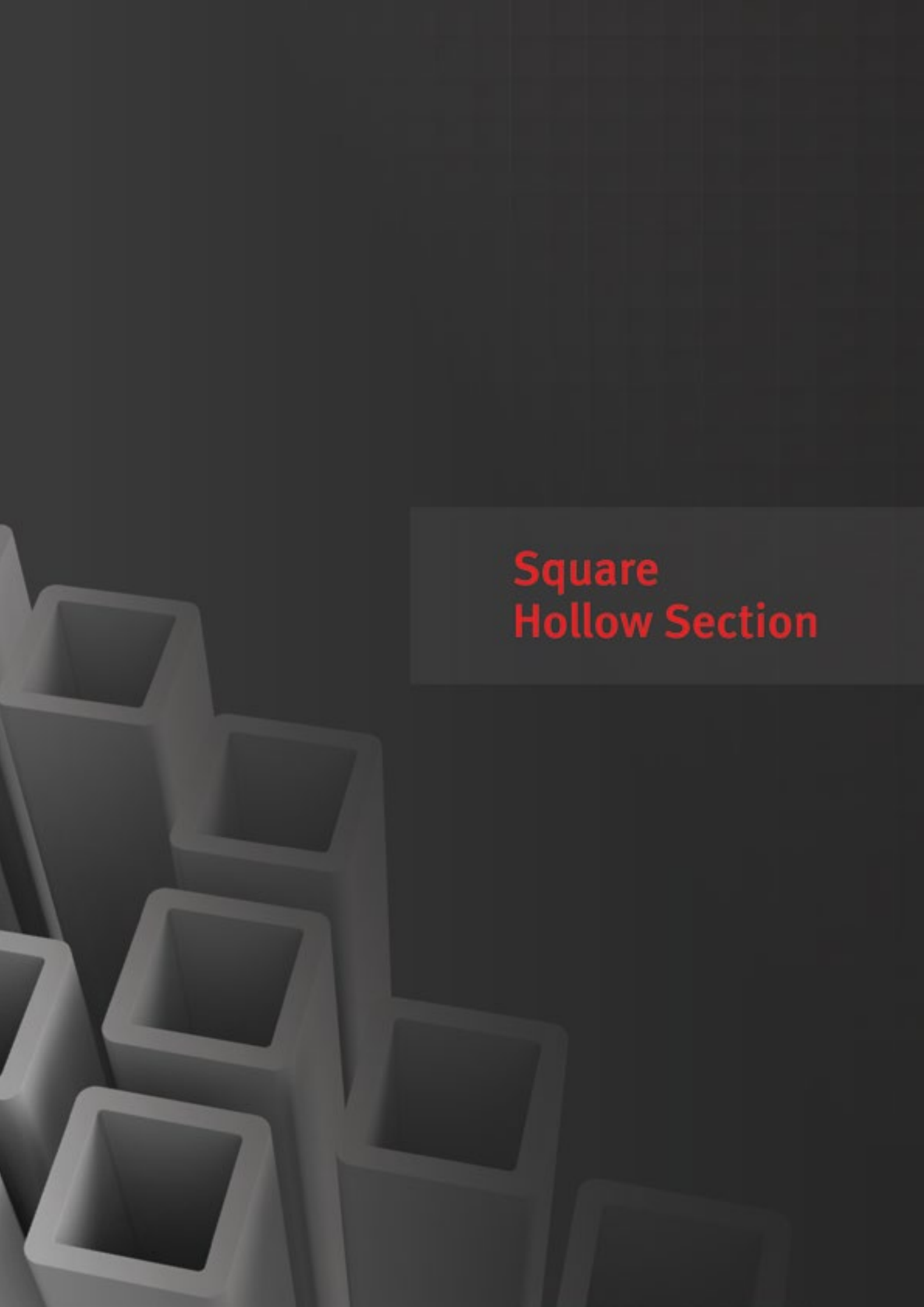
A stack of square hollow sections (SHS) is shown in the bottom-left corner of the image. The sections are arranged in a slightly overlapping, ascending pattern. The background is a dark, solid grey color. The text 'Square Hollow Section' is positioned in the upper right quadrant of the image, enclosed in a semi-transparent dark grey rectangular box.

Square Hollow Section

Beams - Allowable Uniform Loads

Part: 76.2 x 6.4mm Square Hollow Section

Part Number: F-P-SHS(76/76/6.4)

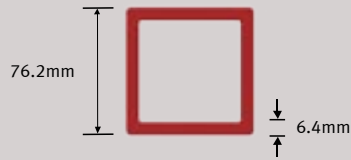

A_w

806mm²

Wt.

3.08kg/m

I

1456810mm⁴

S

38182mm³

Span (m)	Maximum Load (N/m)		Deflection (N/m)				
			L/100	L/150	L/180	L/240	L/360
1.22	13645	F_v	10362	6888	5735	4291	2846
1.52	9019	F_b	5546	3678	3065	2277	1503
1.83	6246	F_b	3269	2175	1795	1343	876
2.13	4583	F_b	2072	1372	1138	846	540
2.44	3503	F_b	1401	919	759	555	350
2.74	2758	F_b	978	628	525	379	234
3.05	2218	F_b	701	452	365	263	161
3.35	1824	F_b	525	336	263	190	117
3.66	1532	F_b	394	248	204	131	73

The part weight has been deducted in the above table.

Part: 88.9 x 6.4mm Square Hollow Section

Part Number: F-P-SHS(89/89/6.4)

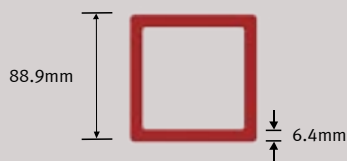

A_w

967mm²

Wt.

3.71kg/m

I

2385006mm⁴

S

53585mm³

Span (m)	Maximum Load (N/m)		Deflection (N/m)				
			L/100	L/150	L/180	L/240	L/360
1.22	16374	F_v	16243	10814	9004	6742	4480
1.52	12682	F_b	8829	5867	4889	3649	2423
1.83	8786	F_b	5268	3503	2904	2175	1430
2.13	6451	F_b	3741	2233	1853	1386	905
2.44	4933	F_b	2277	1503	1240	919	598
2.74	3882	F_b	1605	1051	876	642	409
3.05	3138	F_b	1168	759	628	467	292
3.35	2583	F_b	876	569	467	336	204
3.66	2160	F_b	657	423	350	248	146
3.96	1839	F_b	511	321	263	190	117
4.27	1576	F_b	409	248	204	146	88

The part weight has been deducted in the above table.

Beams - Allowable Uniform Loads

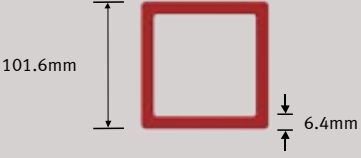
Part: 101.6 x 6.4mm Square Hollow Section							
Part Number: F-P-SHS(102/102/6.4)							
			A_w	1129.032mm ²	Wt.	5.0538kg/m	
			I	3671157.42mm ⁴	S	72266.58mm ³	
Span (m)	Maximum Load (N/m)		Deflection (N/m)				
			L/100	L/150	L/180	L/240	L/360
0.91	44296	F_b	---	30110	25092	18819	12546
1.22	24917	F_b	---	14750	12291	9219	6146
1.52	15947	F_b	12241	8161	6800	5100	3400
1.83	11074	F_b	7408	4939	4116	3087	2058
2.13	8136	F_b	4798	3198	2665	1999	1333
2.44	6229	F_b	3274	2183	1819	1364	910
2.74	4922	F_b	2330	1553	1294	971	647
3.05	3987	F_b	1714	1143	952	714	476
3.35	3295	F_b	1297	865	721	540	360
3.66	2769	F_b	1004	670	558	419	220
3.96	2359	F_b	793	529	441	331	8075
4.27	2034	F_b	637	425	354	266	177
4.57	1772	F_b	520	346	289	216	144
4.88	1557	F_b	429	286	238	179	119
5.18	1379	F_b	358	239	199	149	100
5.49	1230	F_b	302	202	168	126	84
5.79	1104	F_b	257	172	143	107	72
6.10	997	F_b	221	147	123	92	61
6.40	904	F_b	191	127	106	80	53
6.71	824	F_b	166	111	92	69	46
7.01	754	F_b	146	97	81	61	40
7.32	288	F_b	128	86	71	53	36
7.62	638	F_b	114	76	63	47	32
7.92	590	F_b	101	67	56	42	28

The part weight has been deducted in the above table.

Beams - Allowable Uniform Loads

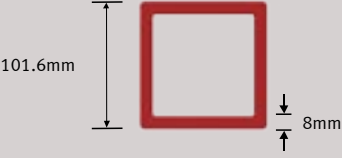
Part: 101.6 x 8mm Square Hollow Section							
Part Number: F-P-SHS(102/102/8)							
			A_w	2995.2mm ²	Wt.	5.32kg/m	
			I	4E+06mm ⁴	S	86720.8668mm ³	
Span (m)	Maximum Load (N/m)		Deflection (N/m)				
			L/100	L/150	L/180	L/240	L/360
1.22	51756	F_b	250774	167183	139319	104489	69660
1.52	41541	F_b	161553	107702	89752	67314	44876
1.83	34504	F_b	111455	74304	61920	46440	30960
2.13	29644	F_b	82270	54847	45706	34279	22853
2.44	25878	F_b	62694	41796	34830	26122	17415
2.74	23045	F_b	49717	33144	27620	20715	13810
3.05	20702	F_b	40124	26749	22291	16718	11146
3.35	18849	F_b	33259	22173	18477	13858	9239
3.66	17252	F_b	27864	18576	15480	11610	7740

The part weight has been deducted in the above table.

Beams - Allowable Uniform Loads

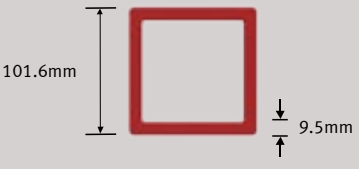
Part: 101.6 x 9.5mm Square Hollow Section							
Part Number: F-P-SHS(102/102/9.5)							
			A_w	1574mm ²	Wt.	6.31kg/m	
			I	5007264mm ⁴	S	98486mm ³	
Span (m)	Maximum Load (N/m)		Deflection (N/m)				
			L/100	L/150	L/180	L/240	L/360
1.52	21293	F_v	17951	11938	9939	7443	4933
1.83	16170	F_b	10829	7195	5984	4466	2948
2.13	11865	F_b	6976	4626	3853	2860	1883
2.44	9063	F_b	4743	3138	2598	1926	1270
2.74	7151	F_b	3357	2204	1824	1357	876
3.05	5779	F_b	2452	1605	1328	978	628
3.35	4758	F_b	1839	1197	992	715	452
3.66	3984	F_b	1401	905	744	540	336
3.96	3386	F_b	1095	701	569	409	248
4.27	2904	F_b	861	555	452	321	190
4.57	2525	F_b	686	438	350	248	146
4.88	2204	F_b	555	350	277	190	102
5.18	1956	F_b	452	277	219	146	73
5.49	1737	F_b	365	219	175	117	44
5.79	1547	F_b	306	175	131	88	29
6.10	1386	F_b	248	146	102	58	15

The part weight has been deducted in the above table.

Beams - Allowable Uniform Loads

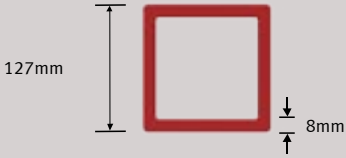
Part: 127 x 8mm Square Hollow Section							
Part Number: F-P-SHS(127/127/8)							
			A_w	3808mm ²	Wt.	6.48kg/m	
			I	9E+06mm ⁴	S	142175.328mm ³	
Span (m)	Maximum Load (N/m)		Deflection (N/m)				
			L/100	L/150	L/180	L/240	L/360
1.22	81250	F_b	513918	342612	285510	214132	142755
1.52	65214	F_b	331075	220717	183931	137948	91965
1.83	54167	F_b	228408	152272	126893	95170	63447
2.13	46538	F_b	168599	112399	93666	70249	46833
2.44	40625	F_b	128479	85653	71377	53533	35689
2.74	36177	F_b	101885	67924	56603	42452	28302
3.05	32500	F_b	82227	54818	45682	34261	22841
3.35	29590	F_b	68159	45439	37866	28400	18933
3.66	27083	F_b	57102	38068	31723	23792	15862

The part weight has been deducted in the above table.

Beams - Allowable Uniform Loads

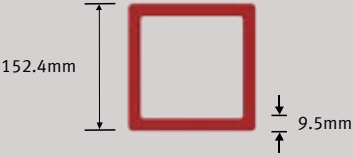
Part: 152.4 x 9.5mm Square Hollow Section							
Part Number: F-P-SHS(152/152/9.5)							
			A_w	2535mm ²	Wt.	9.73kg/m	
			I	9302772mm ⁴	S	122083mm ³	
Span (m)	Maximum Load (N/m)		Deflection (N/m)				
			L/100	L/150	L/180	L/240	L/360
1.52	27428	F_v	----	----	----	23009	15305
1.83	22839	F_v	----	----	19325	14469	9612
2.13	19562	F_v	----	15416	12829	9597	6364
2.44	17104	F_v	16090	10693	8894	6645	4396
2.74	15192	F_v	11578	7685	6387	4765	3142
3.05	13663	F_v	8581	5686	4722	3516	2310
3.35	11563	F_b	6518	4311	3576	2656	1737
3.66	9700	F_b	5055	3336	2763	2047	1330
3.96	8250	F_b	3991	2626	2172	1603	1035
4.27	7099	F_b	3198	2098	1731	1273	815
4.57	6171	F_b	2597	1697	1397	1022	648
4.88	5411	F_b	2132	1387	1139	829	518
5.18	4782	F_b	1768	1145	937	677	417
5.49	4254	F_b	1479	952	776	556	337
5.79	3808	F_b	1246	796	647	459	272
6.10	3426	F_b	1056	670	541	381	220

The part weight has been deducted in the above table.

Interlocking Deckboard

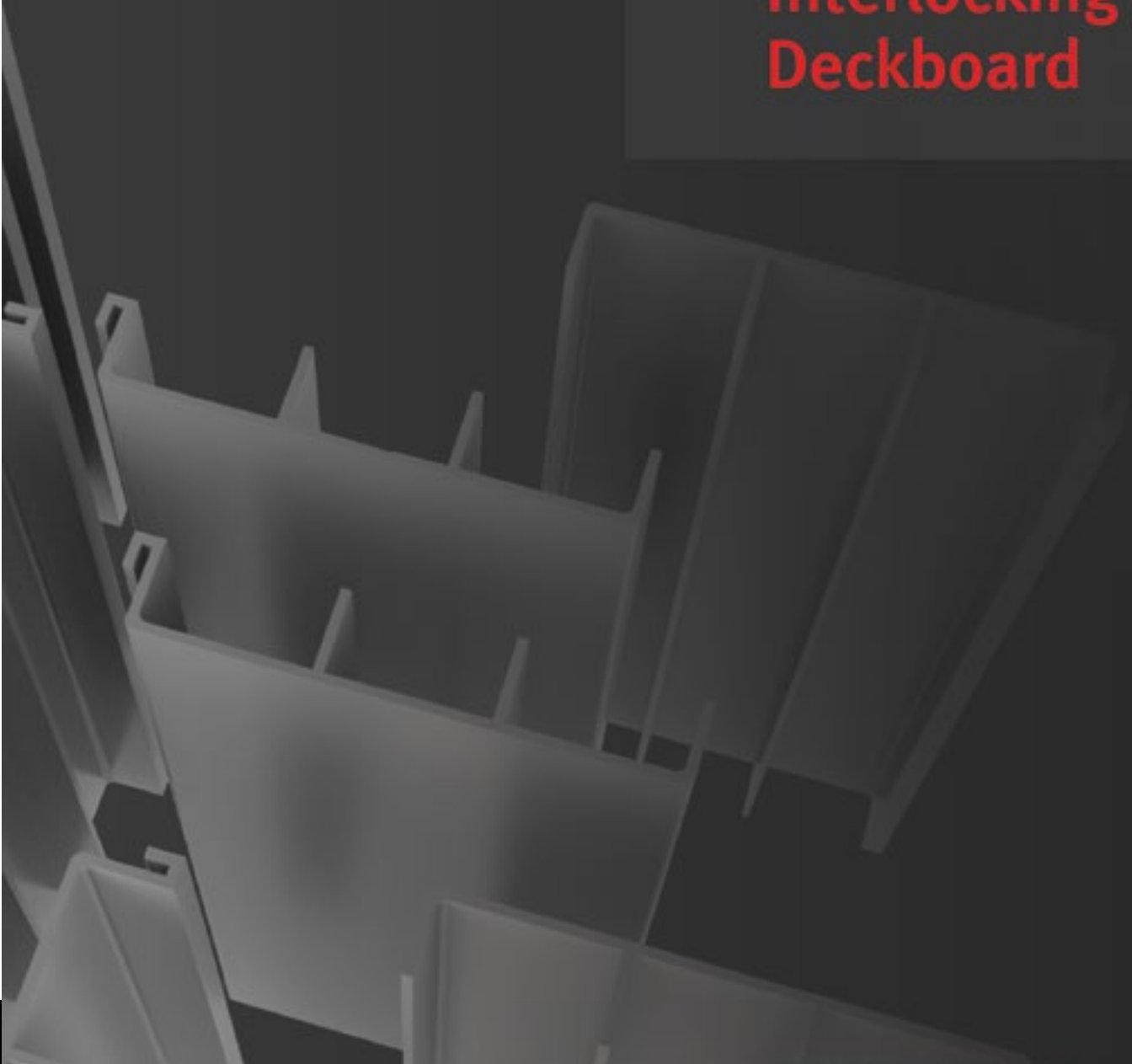

304.8mm Interlocking Deckboard

Part: 304.8mm Interlocking Deckboard

Part Number: F-P-ID(305)

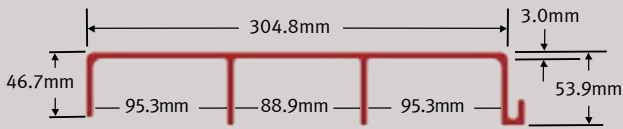

A_w --- Wt. 4.48 kg/m

I 765865mm⁴ S 20811mm³

Span (m)	Load (N/m)	Deflection (N/m)							
		250	500	750	1000	1500	2000	4000	6000
0.5	U	0.1	0.1	0.2	0.2	0.3	0.5	0.9	1.4
---	C	0.1	0.1	0.2	0.3	0.4	0.6	1.2	1.8
0.75	U	0.1	0.3	0.4	0.5	0.8	1.1	2.2	3.2
---	C	0.2	0.4	0.6	0.7	1.1	1.5	3.0	4.5
1	U	0.3	0.5	0.8	1.1	1.6	2.2	4.3	6.5
---	C	0.4	0.8	1.2	1.6	2.4	3.1	6.3	---
1.25	U	0.5	1.0	1.4	1.9	2.9	3.9	7.7	11.6
---	C	0.7	1.4	2.2	2.9	4.3	5.8	11.6	---
1.5	U	0.8	1.6	2.4	3.2	4.7	6.3	12.6	19.0
---	C	1.2	2.4	3.6	4.8	7.2	9.6	---	---
1.75	U	1.2	2.4	3.6	4.9	7.3	9.7	19.4	---
---	C	1.9	3.7	5.6	7.5	11.2	15.0	---	---
2	U	1.8	3.5	5.3	7.1	10.6	14.2	---	---
---	C	2.8	5.5	8.3	11.0	16.6	22.1	---	---

U Millimeters deflection for Uniform Load

C Millimeters deflection for Concentrated Load

LOAD Total Newtons uniformly loaded load across width of one deckboard or Total Newtons Concentrated Center

609.6 X 28.6mm Interlocking Deckboard

Part: 609.6 x 28.6mm Interlocking Deckboard

Part Number: F-P-ID(610/29)

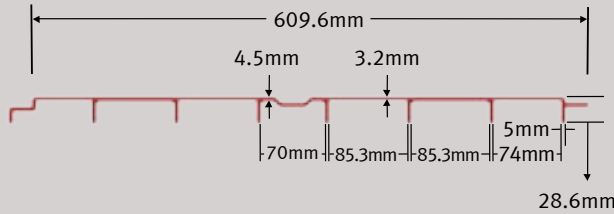

A_w	---	Wt.	5.66 kg/m
I	183142mm ⁴	S	8357mm ³

Span (m)	Load (N/m)	Deflection (N/m)							
		250	500	750	1000	1500	2000	4000	5000
0.5	U	0.1	0.2	0.3	0.5	0.7	0.9	1.8	2.3
---	C	0.2	0.3	0.5	0.7	1	1.3	2.7	3.4
0.75	U	0.3	0.7	1	1.4	2	2.7	5.4	6.8
---	C	0.5	1	1.6	2.1	3.1	4.2	8.3	10.4
1	U	0.8	1.5	2.3	3.1	4.6	6.1	12.2	---
---	C	1.2	2.4	3.6	4.8	7.2	9.6	---	---
1.25	U	1.5	2.9	4.4	5.8	8.8	11.7	---	---
---	C	2.3	4.6	6.9	9.2	13.8	---	---	---
1.5	U	2.5	5	7.5	10	14.9	19.9	---	---
---	C	3.9	7.9	11.8	15.8	---	---	---	---
1.75	U	3.9	7.8	11.8	15.7	23.5	---	---	---
---	C	6.2	12.5	18.7	---	---	---	---	---
2	U	5.8	11.7	17.5	23.3	---	---	---	---
---	C	9.3	18.5	27.8	---	---	---	---	---

U Millimeters deflection for Uniform Load

C Millimeters deflection for Concentrated Load

LOAD Total Newtons uniformly loaded across length of span and width of one deckboard or Total Newtons Concentrated Center load across width of one deckboard.

609.6 X 38.1mm Interlocking Deckboard

Part: 609.6 x 38.1mm Interlocking Deckboard

Part Number: F-P-ID(610/38)

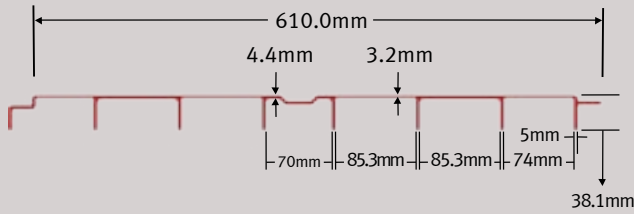

A_w	----	Wt.	7.02 kg/m
I	428718mm ⁴	S	14421mm ³

Span (m)	Load (N/m)	Deflection (N/m)							
		250	500	750	1000	1500	2000	4000	5000
0.5	U	0.1	0.1	0.2	0.2	0.3	0.4	0.9	1.1
----	C	0.1	0.2	0.2	0.3	0.5	0.6	1.3	1.6
0.75	U	0.2	0.3	0.5	0.6	0.9	1.2	2.5	3.1
----	C	0.2	0.5	0.7	0.9	1.4	1.9	3.7	4.7
1	U	0.3	0.7	1.0	1.4	2.0	2.7	5.5	6.8
----	C	0.5	1.1	1.6	2.1	3.2	4.2	8.4	----
1.25	U	0.6	1.3	1.9	2.6	3.9	5.1	10.3	12.8
----	C	1.0	2.0	3.0	4.0	6.0	8.0	----	----
1.5	U	1.1	2.2	3.3	4.3	6.5	8.7	17.4	----
----	C	1.7	3.4	5.1	6.8	10.2	13.6	----	----
1.75	U	1.7	3.4	5.1	6.8	10.2	13.6	----	----
----	C	2.7	5.4	8.1	10.7	16.1	21.5	----	----
2	U	2.5	5.0	7.6	10.1	15.1	----	----	----
----	C	4	8.0	12.0	15.9	23.9	----	----	----

U Millimeters deflection for Uniform Load

C Millimeters deflection for Concentrated Load

LOAD Total Newtons uniformly loaded across length of span and width of one deckboard or Total Newtons Concentrated Center load across width of one deckboard.



Flat Sheet

6.4mm Flat Sheet

Part: 6.4mm Flat Sheet

Part Number: F-P(6.4)

SPAN Lengthwise direction of the Flat Sheet
 For span in the crosswise direction of the Flat Sheet multiply load by 0.70
 Maximum loads shown are for deflections of the lesser of t/2 or L/100

Span (m)	Load (N/m)	Deflection (N/m)						
		200	300	400	500	750	1000	1200
0.5	U	0.55	0.83	1.1	1.38	2.07	2.76	3.31
	C	1.78	2.68	3.57	----	----	----	----
0.75	Load	100	125	200	250	----	----	----
	U	1.40	1.75	2.8	3.49	----	----	----
	C	3.01	3.76	----	----	----	----	----
1	Load	50	75	----	----	----	----	----
	U	2.21	3.31	----	----	----	----	----
	C	3.57	----	----	----	----	----	----

LOAD N/m.² for Uniform Load or N/m. of Width for Concentrated Center Load. U mm. Deflection for Uniform Load

C mm. Deflection for Concentrated Load

Part: 9.5mm Flat Sheet

Part Number: F-P(9.5)

SPAN Lengthwise direction of the Flat Sheet
 For span in the crosswise direction of the Flat Sheet multiply load by 0.70
 Maximum loads shown are for deflections of the lesser of t/2 or L/100

Span (m)	Load (N/m)	Deflection (N/m)										
		500	1000	2000	4000	6000	9500	15000	20000	30000	40000	60000
0.5	U	0.41	0.83	1.65	3.30	4.96	7.85	12.39	16.52	24.78	33.04	49.56
	C	1.32	2.64	5.29	10.57	15.86	25.11	39.65	52.87	79.31	105.74	158.61
0.75	Load	200	500	1000	1500	1800	3000	4000	5000	6000	----	----
	U	0.84	2.09	4.18	6.27	7.52	12.54	16.72	20.90	25.08	----	----
	C	1.78	4.46	8.92	13.38	16.05	26.75	35.67	44.59	53.51	----	----
1	Load	100	200	400	550	600	800	1000	1200	----	----	----
	U	1.32	2.64	5.28	7.26	7.92	10.57	13.21	15.85	----	----	----
	C	2.11	4.23	8.45	11.62	12.68	16.91	21.13	25.36	----	----	----
1.25	Load	100	200	225	300	360	----	----	----	----	----	----
	U	3.22	6.45	7.26	9.67	11.61	----	----	----	----	----	----
	C	4.13	8.25	9.29	12.38	14.86	----	----	----	----	----	----
1.5	Load	50	100	120	150	----	----	----	----	----	----	----
	U	3.64	6.69	8.02	10.03	----	----	----	----	----	----	----
	C	3.57	7.13	8.56	10.70	----	----	----	----	----	----	----

LOAD N/m.² for Uniform Load or N/m. of Width for Concentrated Center Load. U mm. Deflection for Uniform Load

C mm. Deflection for Concentrated Load

12.7mm Flat Sheet

Part: 12.7mm Flat Sheet

Part Number: F-P(12.7)

SPAN Lengthwise direction of the Flat Sheet
 For span in the crosswise direction of the Flat Sheet multiply load by 0.70
 Maximum loads shown are for deflections of the lesser of t/2 or L/100

Span (m)	Load (N/m)	Deflection (N/m)										
		5000	10000	20000	30000	40000	50000	60000	70000	80000	90000	100000
0.25	U	0.02	0.11	0.22	0.43	0.86	1.08	1.29	1.51	1.73	1.94	1.94
	C	0.14	0.70	1.39	2.79	----	----	----	----	----	----	----
0.5	Load	1000	2000	4000	4500	6000	7000	8000	9000	10000	12000	15000
	U	0.35	0.69	1.38	1.55	2.07	2.42	2.76	3.11	3.45	4.14	5.18
	C	1.12	2.23	4.46	5.02	----	----	----	----	----	----	----
0.75	Load	500	1000	1500	1700	2000	2500	3000	3500	3650	----	----
	U	0.87	1.75	2.62	2.97	3.49	4.37	5.24	6.12	6.38	----	----
	C	1.88	3.76	5.65	6.40	----	----	----	----	----	----	----
1	Load	200	300	500	715	800	900	1000	1100	1150	----	----
	U	1.10	1.66	2.76	3.95	4.42	4.97	5.52	6.07	6.35	----	----
	C	1.78	2.68	4.46	6.38	----	----	----	----	----	----	----
1.25	Load	50	100	200	300	370	400	475	----	----	----	----
	U	0.67	1.35	2.70	4.04	4.99	5.39	6.40	----	----	----	----
	C	0.87	1.74	3.48	5.23	6.45	----	----	----	----	----	----

LOAD N/m.² for Uniform Load or N/m. of Width for Concentrated Center Load. U mm. Deflection for Uniform Load

C mm. Deflection for Concentrated Load

Part: 15.9mm Flat Sheet

Part Number: F-FP(15.9)

SPAN Lengthwise direction of the Flat Sheet
 For span in the crosswise direction of the Flat Sheet multiply load by 0.70
 Maximum loads shown are for deflections of the lesser of t/2 or L/100

Span (m)	Load (N/m)	Deflection (N/m)										
		5000	10000	15000	20000	30000	35000	40000	50000	100000	200000	230000
0.25	U	0.06	0.11	0.17	0.22	0.33	0.39	0.44	0.55	1.10	2.21	2.54
	C	0.36	0.71	1.07	1.43	2.14	2.50	---	---	---	---	---
0.5	Load	1000	2000	4000	6000	8800	10000	15000	20000	25000	28000	---
	U	0.18	0.35	0.71	1.06	1.56	1.77	2.65	3.53	4.42	4.95	---
	C	0.57	1.14	2.28	3.43	5.02	---	---	---	---	---	---
0.75	Load	1000	2000	3000	3900	5000	6000	7000	8400	---	---	---
	U	0.89	1.79	2.68	3.49	4.47	5.37	6.26	7.52	---	---	---
	C	1.93	3.85	5.78	7.52	---	---	---	---	---	---	---
1	Load	500	600	800	1000	1500	1650	2000	2500	2700	---	---
	U	1.41	1.70	2.26	2.83	4.24	4.67	5.66	7.07	7.63	---	---
	C	2.28	2.74	3.65	4.57	6.85	7.54	---	---	---	---	---
1.25	Load	200	400	600	800	850	1000	1100	---	---	---	---
	U	1.38	2.76	4.14	5.52	5.87	6.9	7.59	---	---	---	---
	C	1.78	3.57	5.35	7.14	7.58	---	---	---	---	---	---
1.5	Load	200	300	400	500	530	---	---	---	---	---	---
	U	2.86	4.29	5.73	7.16	7.59	---	---	---	---	---	---
	C	3.08	4.62	6.17	7.71	---	---	---	---	---	---	---
1.75	Load	200	300	310	---	---	---	---	---	---	---	---
	U	5.30	7.96	---	---	---	---	---	---	---	---	---
	C	4.90	7.34	7.59	---	---	---	---	---	---	---	---

LOAD N/m.² for Uniform Load or N/m. of Width for Concentrated Center Load. U mm. Deflection for Uniform Load

C mm. Deflection for Concentrated Load

19.0mm Flat Sheet

Part: 19.0mm Flat Sheet

Part Number: F-FP(19)

SPAN Lengthwise direction of the Flat Sheet
 For span in the crosswise direction of the Flat Sheet multiply load by 0.70
 Maximum loads shown are for deflections of the lesser of t/2 or L/100

Span (m)	Load (N/m)	Deflection (N/m)									
		5000	10000	20000	30000	40000	50000	61000	100000	150000	200000
0.25	U	0.03	0.06	0.13	0.19	0.26	0.32	0.39	0.64	0.96	1.28
	C	0.21	0.41	0.83	1.24	1.65	2.07	2.52	----	----	----
0.5	Load	1000	2000	5000	8000	10000	12000	15000	20000	25000	30000
	U	0.1	0.2	0.51	0.82	1.02	1.23	1.53	2.05	2.56	3.07
	C	0.33	0.66	1.65	2.64	3.30	3.97	4.96	6.61	8.26	9.91
0.75	Load	1000	2000	3000	4000	5000	6000	6800	8000	10000	12000
	U	0.52	1.04	1.55	2.07	2.59	3.11	3.52	4.14	5.18	6.21
	C	1.12	2.23	3.35	4.46	5.58	6.69	7.58	----	----	----
1	Load	1000	2000	2500	3000	3600	4000	4500	5000	5500	5900
	U	1.64	3.27	4.09	4.91	5.89	6.55	7.36	8.18	9	9.65
	C	2.64	5.29	6.61	7.93	9.52	----	----	----	----	----
1.25	Load	1000	1200	1500	1850	2000	2200	2300	2400	----	----
	U	3.99	4.79	5.99	7.39	7.99	8.79	9.19	9.59	----	----
	C	5.16	6.20	7.74	9.55	----	----	----	----	----	----
1.5	Load	400	600	700	800	900	1000	1150	----	----	----
	U	3.31	4.97	5.80	6.63	7.46	8.28	9.53	----	----	----
	C	3.57	5.35	6.24	7.14	8.03	8.92	10.26	----	----	----

LOAD N/m.² for Uniform Load or N/m. of Width for Concentrated Center Load. U mm. Deflection for Uniform Load

C mm. Deflection for Concentrated Load

Part: 25.4mm Flat Sheet

Part Number: F-FP(25.4)

SPAN Lengthwise direction of the Flat Sheet
 For span in the crosswise direction of the Flat Sheet multiply load by 0.70
 Maximum loads shown are for deflections of the lesser of t/2 or L/100

Span (m)	Load (N/m)	Deflection (N/m)										
		100	200	500	800	1000	2000	3000	4000	5000	6640	8000
0.5	U	0.22	0.43	0.65	0.86	1.08	1.29	1.55	2.16	3.24	4.31	5.00
	C	0.70	1.39	2.09	2.79	3.48	4.18	5.02	----	----	----	---
0.75	Load	1000	5000	7500	10000	15000	16000	20000	25000	30000	34500	----
	U	0.22	1.09	1.64	2.18	3.28	3.49	4.37	5.46	6.55	7.54	----
	C	0.47	2.35	3.53	4.70	7.06	7.53	----	----	----	----	----
1	Load	1000	2000	5000	7500	9000	10000	12000	14000	14500	----	----
	U	0.69	1.38	3.45	5.18	6.21	6.90	8.28	9.66	10.01	----	----
	C	1.12	2.23	5.58	8.36	10.04	----	----	----	----	----	----
1.25	Load	1000	2000	3000	4000	5000	6000	7000	7500	----	----	----
	U	1.69	3.37	5.06	6.74	8.43	10.11	11.80	12.64	----	----	----
	C	2.18	4.36	6.53	8.71	10.89	13.07	----	----	----	----	----
1.5	Load	1000	2000	3000	3400	3600	----	----	----	----	----	----
	U	3.49	6.99	10.48	11.88	12.58	----	----	----	----	----	----
	C	3.76	7.53	11.29	12.80	----	----	----	----	----	----	----
1.75	Load	1000	1500	2000	2100	----	----	----	----	----	----	----
	U	6.47	9.71	12.95	----	----	----	----	----	----	----	----
	C	5.98	8.96	11.95	12.55	----	----	----	----	----	----	----
2	Load	1000	1150	1450	----	----	----	----	----	----	----	----
	U	11.05	12.70	16.02	----	----	----	----	----	----	----	----
	C	8.92	10.26	12.94	----	----	----	----	----	----	----	----

LOAD N/m.² for Uniform Load or N/m. of Width for Concentrated Center Load. U mm. Deflection for Uniform Load

C mm. Deflection for Concentrated Load

Columns



Columns

Full section column testing was conducted on Treadwell Group's Equal Leg Angles, I-Beams, WF-Beams, and Square Hollow Section. Ultimate stress vs. slenderness ratio curves were developed from the testing. The curves developed are based on the Euler Buckling Stress Equation and a straight line transition from Euler Buckling to ultimate stress

$$\left[\pi^2 E / \left(\frac{K}{r} \right)^2 \right]$$

The allowable concentric axial load tables were generated from these curves. The tables are based on a safety factor of three.

Notation	
A	area (mm. ²)
b	width of flange/leg/wall (mm.)
t	thickness of flange (mm.)
r	minimum radius gyration (mm.)
l	length (m.)
K	effective column length factor
F _a	allowable column concentric axial stress (MPa)
P _a	allowable column centric axial load (N.)

Angle	Maximum allowable stress	
	b/t = 6	41.3MPa
	b/t = 8	33.5MPa
	b/t = 10.7	24.1MPa
	b/t = 12	19.5MPa
	b/t = 16	12.6MPa

WF- & I-Beam	Maximum allowable stress	
	b/t ≤ 12	68.9MPa
	b/t = 13.3	68.9MPa
	b/t = 16	50.5MPa
	b/t = 20	32.3MPa
	b/t = 21.3	28.4MPa
	b/t = 24	22.4MPa
	b/t = 26.7	18.1MPa

Square Hollow Section (6.35mm wall)	Maximum allowable stress	
	b/t ≤ 16	68.9MPa

Columns-Allowable Concentric Axial Stresses and Loads





Angle

Columns – Allowable Concentric Axial Stresses and Loads

Part: 50.8 x 50.8 x 6.4mm Angle

Part Number: F-P-ELA(51/51/6.4)



A	593.5mm ²
r	9.65mm

Effective Length (m)	F _a (kPa)	P _a (N)
0.30	24207	14368
0.46	19550	11604
0.61	14892	8839
0.76	10234	6075
0.91	7077	4200
1.07	5199	3086
1.22	3981	2363
1.37	3145	1867
1.52	2548	1512
1.68	2105	1250
1.83	1769	1050

Part: 76.2 x 76.2 x 6.4mm Angle

Part Number: F-P-ELA(76/76/6.4)

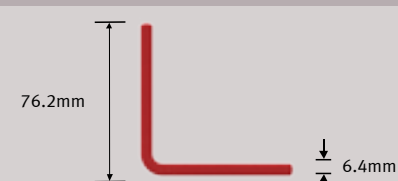

A	916.1mm ²
r	14.99mm

Effective Length (m)	F _a (kPa)	P _a (N)
0.30	16852	15438
0.46	15511	14210
0.61	14171	12982
0.76	12830	11754
0.91	11490	10526
1.07	10149	9298
1.22	8809	8070
1.37	7468	6842
1.52	6141	5626
1.68	5075	4650
1.83	4265	3907
1.98	3634	3329
2.13	3133	2871
2.29	2729	2501
2.44	2399	2198
2.59	2125	1947
2.74	1895	1736
2.90	1701	1559

Columns – Allowable Concentric Axial Stresses and Loads

Part: 76.2 x 76.2 x 9.5mm Angle

Part Number: F-P-ELA(76/76/9.5)



A	1348.4mm ²
r	14.99mm

Effective Length (m)	F _a (kPa)	P _a (N)
0.30	27523	37111
0.46	24523	33066
0.61	21523	29021
0.76	18523	24976
0.91	15523	20932
1.07	12524	16887
1.22	9596	12939
1.37	7582	10223
1.52	6141	8281
1.68	5075	6844
1.83	4265	5751
1.98	3634	4900
2.13	3133	4225
2.29	2729	3680
2.44	2399	3235
2.59	2125	2865
2.74	1895	2556
2.90	1701	2294

Part: 76.2 x 76.2 x 12.7mm Angle

Part Number: F-P-ELA(76/76/12.7)



A	1741.9mm ²
r	14.99mm

Effective Length (m)	F _a (kPa)	P _a (N)
0.30	33326	58051
0.46	29304	51046
0.61	25283	44041
0.76	21262	37036
0.91	17059	29716
1.07	12533	21832
1.22	9596	16715
1.37	7582	13207
1.52	6141	10698
1.68	5075	8841
1.83	4265	7429
1.98	3634	6330
2.13	3133	5458
2.29	2729	4755
2.44	2399	4179
2.59	2125	3702
2.74	1895	3302
2.90	1701	2963

Columns – Allowable Concentric Axial Stresses and Loads

Part: 101.6 x 101.6 x 6.4mm Angle			
Part Number: F-P-ELA(102/102/6.4)			
	A	1225.8mm ²	
	r	20.32mm	
Effective Length (m)	F _a (kPa)	P _a (N)	
0.30	11610	14381	
0.46	11095	13744	
0.61	10581	13107	
0.76	10067	12470	
0.91	9553	11833	
1.07	9039	11196	
1.22	8524	10559	
1.37	8010	9922	
1.52	7496	9285	
1.68	6982	8648	
1.83	6467	8011	
1.98	5953	7374	
2.13	5439	6737	
2.29	4925	6100	
2.44	4411	5463	
2.59	3907	4840	
2.74	3485	4317	
2.90	3128	3874	
3.05	2823	3497	

Columns – Allowable Concentric Axial Stresses and Loads

Part: 101.6 x 101.6 x 9.5mm Angle		
Part Number: F-P-ELA(102/102/9.5)		
	A	1832.3mm ²
	r	20.07mm
Effective Length (m)	F _a (kPa)	P _a (N)
0.30	21388	39188
0.46	20013	36668
0.61	18637	34148
0.76	17262	31628
0.91	15887	29108
1.07	14511	26588
1.22	13136	24068
1.37	11761	21549
1.52	10385	19029
1.68	9010	16509
1.83	7646	14010
1.98	6515	11937
2.13	5618	10293
2.29	4894	8966
2.44	4301	7881
2.59	3810	6981
2.74	3398	6227
2.90	3050	5588
3.05	2753	5044
3.20	2497	4575
3.35	2275	4168
3.51	2081	3814
3.66	1912	3502
3.81	1762	3228

Columns – Allowable Concentric Axial Stresses and Loads

Part: 101.6 x 101.6 x 12.7mm Angle		
Part Number: F-P-ELA(102/102/12.7)		
	A	2387.1mm ²
	r	19.81mm
Effective Length (m)	F _a (kPa)	P _a (N)
0.30	28984	69188
0.46	26715	63771
0.61	24446	58355
0.76	22177	52938
0.91	19908	47522
1.07	17639	42105
1.22	15370	36689
1.37	13101	31272
1.52	10831	25856
1.68	8871	21175
1.83	7454	17793
1.98	6351	15161
2.13	5476	13072
2.29	4770	11388
2.44	4193	10009
2.59	3714	8866
2.74	3313	7908
2.90	2973	7098
3.05	2683	6406
3.20	2434	5810
3.35	2218	5294
3.51	2029	4843
3.66	1863	4448

Columns – Allowable Concentric Axial Stresses and Loads

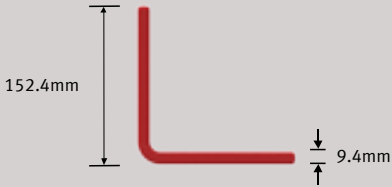
152.4 x 152.4 x 9.4mm Angle		
	A	2794mm ²
	r	28.96mm
Effective Length (m)	F _a (kPa)	P _a (N)
0.30	11916	33289
0.46	11556	32281
0.61	11195	31273
0.76	10834	30265
0.91	10473	29257
1.07	10112	28249
1.22	9751	27241
1.37	9390	26232
1.52	9030	25224
1.68	8669	24216
1.83	8308	23208
1.98	7947	22200
2.13	7586	21192
2.29	7225	20184
2.44	6864	19176
2.59	6504	18168
2.74	6143	17160
2.90	5782	16152
3.05	5421	15144
3.20	5060	14136
3.35	4699	13128
3.51	4334	12108
3.66	3981	11120
3.81	3668	10248
3.96	3392	9475
4.12	3145	8786
4.27	2924	8170
4.42	2726	7616
4.57	2548	7117
4.72	2386	6665
4.88	2239	6255
5.03	2105	5882
5.18	1983	5541
5.33	1872	5229
5.49	1769	4942
5.64	1675	4679
5.79	1588	4436

Columns – Allowable Concentric Axial Stresses and Loads

152.4 x 152.4 x 12.7mm Angle		
	A	3677.4mm ²
	r	30.2mm
Effective Length (m)	F _a (kPa)	P _a (N)
0.30	18204	66942
0.46	17539	64498
0.61	16874	62054
0.76	16210	59610
0.91	15545	57166
1.07	14881	54722
1.22	14216	52278
1.37	13551	49834
1.52	12887	47390
1.68	12222	44945
1.83	11557	42501
1.98	10893	40057
2.13	10228	37613
2.29	9564	35169
2.44	8899	32725
2.59	8234	30281
2.74	7570	27837
2.90	6905	25393
3.05	6246	22968
3.20	5665	20833
3.35	5162	18982
3.51	4723	17367
3.66	4337	15950
3.81	3997	14700
3.96	3696	13591
4.12	3427	12603
4.27	3187	11719
4.42	2971	10924
4.57	2776	10208
4.72	2600	9560
4.88	2440	8972
5.03	2294	8437
5.18	2161	7948
5.33	2039	7500
5.49	1928	7089
5.64	1825	6711
5.79	1730	6362

I-Beam



Columns – Allowable Concentric Axial Stresses and Loads

76.2 x 38.1 x 6.4mm I-Beam			
		A	890mm ²
		r	8mm
Effective Length (m)	F _a (kPa)	P _a (N)	
0.30	36164	32198	
0.46	20073	17871	
0.61	11291	10053	
0.76	7226	6434	
0.91	5018	4468	
1.07	3687	3283	
1.22	2823	2513	
1.37	2230	1986	
1.52	1807	1608	
1.68	1493	1329	
1.83	1255	1117	
1.98	1069	952	
2.13	922	821	
2.29	803	715	
2.44	706	628	
2.59	625	557	
2.74	558	496	
2.90	500	446	
3.05	452	402	
3.20	410	365	
3.35	373	332	
3.51	342	304	
3.66	314	279	
3.81	289	257	
3.96	267	238	
4.12	248	221	
4.27	230	205	
4.42	215	191	
4.57	201	179	
4.72	188	167	
4.88	176	157	
5.03	166	148	
5.18	156	139	
5.33	147	131	
5.49	139	124	
5.64	132	117	
5.79	125	111	
5.94	119	106	
6.10	113	101	

Columns – Allowable Concentric Axial Stresses and Loads

101.6 x 50.8 x 6.4mm I-Beam		
	A	1213mm ²
	r	11mm
Effective Length (m)	F _a (kPa)	P _a (N)
0.30	44551	54036
0.46	32352	39240
0.61	20388	24728
0.76	13408	15823
0.91	9061	10990
1.07	6657	8075
1.22	5097	6182
1.37	4027	4885
1.52	3262	3957
1.68	2696	3270
1.83	2265	2748
1.98	1930	2341
2.13	1664	2019
2.29	1450	1758
2.44	1274	1546
2.59	1129	1369
2.74	1007	1221
2.90	904	1096
3.05	816	989
3.20	740	897
3.35	674	817
3.51	617	748
3.66	566	687
3.81	522	633
3.96	483	585
4.12	447	543
4.27	416	505
4.42	388	470
4.57	362	440
4.72	339	412
4.88	319	386
5.03	300	363
5.18	282	342
5.33	266	323
5.49	252	305
5.64	238	289
5.79	226	274
5.94	214	260
6.10	204	247

Columns – Allowable Concentric Axial Stresses and Loads

152.4 x 76.2 x 6.4mm I-Beam			
		A	1858mm ²
		r	16mm
Effective Length (m)	F _a (kPa)	P _a (N)	
0.30	44551	54036	
0.46	32352	39240	
0.61	20388	24728	
0.76	13048	15823	
0.91	9061	10990	
1.07	6657	8075	
1.22	5097	6182	
1.37	4027	4885	
1.52	3262	3957	
1.68	2696	3270	
1.83	2265	2748	
1.98	1930	2341	
2.13	1664	2019	
2.29	1450	1758	
2.44	1274	1546	
2.59	1129	1369	
2.74	1007	1221	
2.90	904	1096	
3.05	816	989	
3.20	740	897	
3.35	674	817	
3.51	617	748	
3.66	566	687	
3.81	522	633	
3.96	483	585	
4.12	447	543	
4.27	416	505	
4.42	388	470	
4.57	362	440	
4.72	339	412	
4.88	319	386	
5.03	300	363	
5.18	282	342	
5.33	266	323	
5.49	252	305	
5.64	238	289	
5.79	226	274	
5.94	214	260	
6.10	204	247	

Columns – Allowable Concentric Axial Stresses and Loads

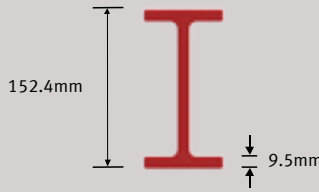
152.4 x 76.2 x 9.5mm I-Beam		
	A	2729mm ²
	r	16mm
Effective Length (m)	F _a (kPa)	P _a (N)
0.30	52556	143427
0.46	44360	121060
0.61	36164	98694
0.76	27969	76327
0.91	20073	54780
1.07	14748	40246
1.22	11291	30814
1.37	8921	24347
1.52	7226	19721
1.68	5972	16298
1.83	5018	13695
1.98	4276	11669
2.13	3687	10062
2.29	3212	8765
2.44	2823	7703
2.59	2500	6824
2.74	2230	6087
2.90	2002	5463
3.05	1807	4930
3.20	1639	4472
3.35	1493	4075
3.51	1366	3728
3.66	1255	3424
3.81	1156	3155
3.96	1069	2917
4.12	991	2705
4.27	922	2515
4.42	859	2345
4.57	803	2191
4.72	752	2052
4.88	706	1926
5.03	664	1811
5.18	625	1706
5.33	590	1610
5.49	558	1522
5.64	528	1441
5.79	500	1366
5.94	475	1297
6.10	452	1233

Columns – Allowable Concentric Axial Stresses and Loads

203.2 x 101.6 x 9.5mm I-Beam		
	A	3697mm ²
	r	21mm
Effective Length (m)	F _a (kPa)	P _a (N)
0.30	56459	208715
0.46	50214	185631
0.61	43970	162547
0.76	37726	139462
0.91	31481	116378
1.07	25237	93294
1.22	19451	71904
1.37	15368	56813
1.52	12448	46019
1.68	10288	38032
1.83	8645	31958
1.98	7366	27230
2.13	6351	23479
2.29	5533	20453
2.44	4863	17976
2.59	4307	15923
2.74	3842	14203
2.90	3448	12748
3.05	3112	11505
3.20	2823	10435
3.35	2572	9508
3.51	2353	8699
3.66	2161	7989
3.81	1992	7363
3.96	1841	6808
4.12	1708	6313
4.27	1588	5870
4.42	1480	5472
4.57	1383	5113
4.72	1295	4789
4.88	1216	4494
5.03	1143	4226
5.18	1077	3981
5.33	1016	3757
5.49	961	3551
5.64	909	3361
5.79	862	3187
5.94	818	3026
6.10	778	2876

Columns – Allowable Concentric Axial Stresses and Loads

203.2 x 101.6 x 12.7mm I-Beam			
		A	4845mm ²
		r	22mm
Effective Length (m)	F _a (kPa)	P _a (N)	
0.30	56606	274263	
0.46	50435	244364	
0.61	44264	214465	
0.76	38093	184566	
0.91	31922	154666	
1.07	25751	124767	
1.22	19916	96498	
1.37	15736	76246	
1.52	12747	61759	
1.68	10534	51040	
1.83	8852	42888	
1.98	7542	36544	
2.13	6503	31510	
2.29	5665	27448	
2.44	4979	24125	
2.59	4411	21370	
2.74	3934	19061	
2.90	3531	17108	
3.05	3187	15440	
3.20	2890	14004	
3.35	2634	12760	
3.51	2410	11675	
3.66	2213	10722	
3.81	2039	9881	
3.96	1886	9136	
4.12	1748	8472	
4.27	1626	7877	
4.42	1516	7344	
4.57	1416	6862	
4.72	1326	6427	
4.88	1245	6031	
5.03	1170	5671	
5.18	1103	5342	
5.33	1041	5042	
5.49	984	4765	
5.64	931	4511	
5.79	883	4277	
5.94	838	4060	
6.10	797	3860	

Columns – Allowable Concentric Axial Stresses and Loads

254 x 127 x 9.5mm I-Beam			
		A	4658mm ²
		r	26mm
Effective Length (m)	F _a (kPa)	P _a (N)	
0.30	58860	274175	
0.46	53817	250682	
0.61	48773	227189	
0.76	43730	203696	
0.91	38686	180202	
1.07	33643	156709	
1.22	28599	133216	
1.37	23556	109723	
1.52	19082	88885	
1.68	15770	73458	
1.83	13251	61725	
1.98	11291	52594	
2.13	9736	45349	
2.29	8481	39504	
2.44	7454	34721	
2.59	6603	30756	
2.74	5889	27434	
2.90	5286	24622	
3.05	4770	22221	
3.20	4327	20155	
3.35	3943	18365	
3.51	3607	16802	
3.66	3313	15431	
3.81	3053	14222	
3.96	2823	13149	
4.12	2618	12193	
4.27	2434	11337	
4.42	2269	10569	
4.57	2120	9876	
4.72	1986	9249	
4.88	1863	8680	
5.03	1752	8162	
5.18	1651	7689	
5.33	1558	7256	
5.49	1472	6858	
5.64	1394	6493	
5.79	1321	6155	
5.94	1255	5844	
6.10	1193	5555	

Columns – Allowable Concentric Axial Stresses and Loads

254 x 127 x 12.7mm I-Beam			
	A	6135mm ²	
	r	26mm	
Effective Length (m)	F _a (kPa)	P _a (N)	
0.30	58860	361137	
0.46	53817	330192	
0.61	48773	299247	
0.76	43730	268303	
0.91	38686	237358	
1.07	33643	206413	
1.22	28599	175469	
1.37	23556	144524	
1.52	19082	117076	
1.68	15770	96757	
1.83	13251	81303	
1.98	11291	69276	
2.13	9736	59733	
2.29	8481	52034	
2.44	7454	45733	
2.59	6603	40511	
2.74	5889	36135	
2.90	5286	32431	
3.05	4770	29269	
3.20	4327	26548	
3.35	3943	24189	
3.51	3607	22132	
3.66	3313	20326	
3.81	3053	18732	
3.96	2823	17319	
4.12	2618	16060	
4.27	2434	14933	
4.42	2269	13921	
4.57	2120	13008	
4.72	1986	12183	
4.88	1863	11433	
5.03	1752	10751	
5.18	1651	10128	
5.33	1558	9557	
5.49	1472	9034	
5.64	1394	8552	
5.79	1321	8108	
5.94	1255	7697	
6.10	1193	7317	

Columns – Allowable Concentric Axial Stresses and Loads

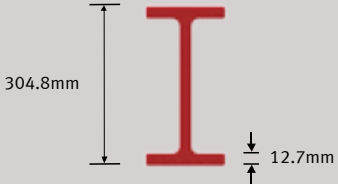
304.8 x 152.4 x 12.7mm I-Beam		
	A	7426mm ²
	r	32mm
Effective Length (m)	F _a (kPa)	P _a (N)
0.30	60622	450164
0.46	56459	419251
0.61	52296	388338
0.76	48133	357425
0.91	43970	326512
1.07	39807	295598
1.22	35644	264685
1.37	31481	233772
1.52	27318	202859
1.68	23148	171891
1.83	19451	144436
1.98	16573	123070
2.13	14290	106116
2.29	12448	92439
2.44	10941	81245
2.59	9692	71968
2.74	8645	64194
2.90	7759	57614
3.05	7002	51997
3.20	6351	47163
3.35	5787	42973
3.51	5295	39317
3.66	4863	36109
3.81	4481	33278
3.96	4143	30767
4.12	3842	28531
4.27	3573	26529
4.42	3330	24731
4.57	3112	23110
4.72	2915	21643
4.88	2735	20311
5.03	2572	19099
5.18	2423	17992
5.33	2286	16979
5.49	2161	16048
5.64	2046	15193
5.79	1940	14404
5.94	1841	13674
6.10	1751	12999



WF-Beam

Columns – Allowable Concentric Axial Stresses and Loads

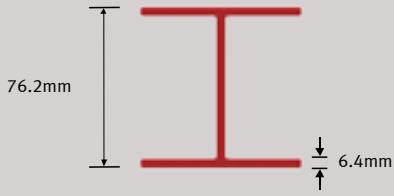
76.2 x 76.2 x 6.4mm WF-Beam		
	A	1374.19mm ²
	r	18.54mm
Effective Length (m)	F _a (kPa)	P _a (N)
0.30	54577	74999
0.46	47392	65125
0.61	40206	55251
0.76	33021	45377
0.91	25835	35503
1.07	19187	26366
1.22	14690	20187
1.37	11607	15950
1.52	9402	12920
1.68	7770	10677
1.83	6529	8972
1.98	5563	7645
2.13	4797	6592
2.29	4178	5742
2.44	3672	5047
2.59	3253	4470
2.74	2902	3988
2.90	2604	3579
3.05	2350	3230
3.20	2132	2930
3.35	1942	2669
3.51	1777	2442
3.66	1632	2243

Columns – Allowable Concentric Axial Stresses and Loads

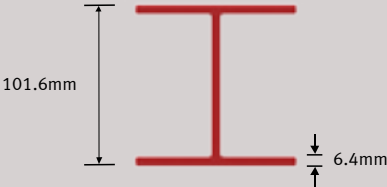
101.6 x 101.6 x 6.4mm WF-Beam			
		A	1864.51mm ²
		r	24.38mm
Effective Length (m)	F _a (kPa)	P _a (N)	
0.30	43630	81348	
0.46	40217	74984	
0.61	36804	68621	
0.76	33390	62257	
0.91	29977	55893	
1.07	26564	49529	
1.22	23151	43166	
1.37	19738	36802	
1.52	16325	30438	
1.68	13437	25054	
1.83	11291	21052	
1.98	9621	17938	
2.13	8295	15467	
2.29	7226	13473	
2.44	6351	11842	
2.59	5626	10490	
2.74	5018	9357	
2.90	4504	8398	
3.05	4065	7579	
3.20	3687	6874	
3.35	3359	6264	
3.51	3074	5731	
3.66	2823	5263	
3.81	2601	4850	
3.96	2405	4485	
4.12	2230	4158	
4.27	2074	3867	
4.42	1933	3605	
4.57	1807	3368	
4.72	1692	3155	
4.88	1588	2960	

Columns – Allowable Concentric Axial Stresses and Loads

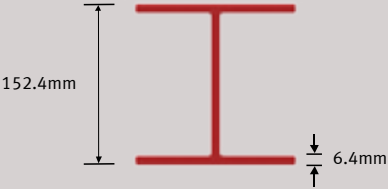
152.4 x 152.4 x 6.4mm WF-Beam			
		A	2832.25mm ²
		r	36.32mm
Effective Length (m)	F _a (kPa)	P _a (N)	
0.30	21067	59668	
0.46	20387	57740	
0.61	19706	55812	
0.76	19025	53884	
0.91	18345	51957	
1.07	17664	50029	
1.22	16983	48101	
1.37	16303	46173	
1.52	15622	44245	
1.68	14941	42317	
1.83	14261	40390	
1.98	13580	38462	
2.13	12899	36534	
2.29	12219	34606	
2.44	11538	32678	
2.59	10857	30750	
2.74	10177	28823	
2.90	9496	26895	
3.05	8815	24967	
3.20	8135	23039	
3.35	7454	21111	
3.51	6820	19315	
3.66	6263	17739	
3.81	5772	16349	
3.96	5337	15115	
4.12	4949	14016	
4.27	4602	13033	
4.42	4290	12150	
4.57	4009	11353	
4.72	3754	10633	
4.88	3523	9978	
5.03	3313	9383	
5.18	3121	8839	
5.33	2945	8341	
5.49	2784	7884	
5.64	2635	7464	
5.79	2498	7076	
5.94	2372	6718	
6.10	2255	6386	

Columns – Allowable Concentric Axial Stresses and Loads

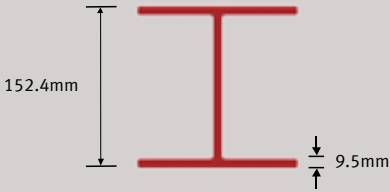
152.4 x 152.4 x 9.5mm WF-Beam		
	A	4180.64mm ²
	r	36.58mm
Effective Length (m)	F _a (kPa)	P _a (N)
0.30	45905	191912
0.46	43630	182400
0.61	41354	172887
0.76	39079	163375
0.91	36804	153862
1.07	34528	144350
1.22	32253	134837
1.37	29977	125324
1.52	27702	115812
1.68	25427	106299
1.83	23151	96787
1.98	20876	87274
2.13	18600	77762
2.29	16325	68249
2.44	14290	59742
2.59	12658	52921
2.74	11291	47204
2.90	10134	42366
3.05	9146	38235
3.20	8295	34680
3.35	7558	31599
3.51	6916	28911
3.66	6351	26552
3.81	5853	24470
3.96	5412	22624
4.12	5018	20979
4.27	4666	19508
4.42	4350	18186
4.57	4065	16993
4.72	3807	15915
4.88	3573	14936
5.03	3359	14044
5.18	3165	13230
5.33	2986	12485
5.49	2823	11801
5.64	2672	11172
5.79	2533	10591
5.94	2405	10055
6.10	2286	9559

Columns – Allowable Concentric Axial Stresses and Loads

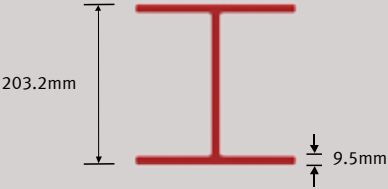
203.2 x 203.2 x 9.5mm WF-Beam			
		A	5632.25mm ²
		r	48.77mm
Effective Length (m)	F_a (kPa)	P_a (N)	
0.30	26943	151752	
0.46	26222	147690	
0.61	25501	143628	
0.76	24780	139566	
0.91	24059	135505	
1.07	23338	131443	
1.22	22616	127381	
1.37	21895	123319	
1.52	21174	119257	
1.68	20453	115196	
1.83	19732	111134	
1.98	19011	107072	
2.13	18289	103010	
2.29	17568	98948	
2.44	16847	94887	
2.59	16126	90825	
2.74	15405	86763	
2.90	14684	82701	
3.05	13962	78639	
3.20	13241	74578	
3.35	12520	70516	
3.51	11799	66454	
3.66	11078	62392	
3.81	10356	58330	
3.96	9621	54187	
4.12	8921	50247	
4.27	8295	46722	
4.42	7733	43556	
4.57	7226	40700	
4.72	6768	38117	
4.88	6351	35772	
5.03	5972	33637	
5.18	5626	31687	
5.33	5309	29902	
5.49	5018	28264	
5.64	4751	26757	
5.79	4504	25367	
5.94	4276	24083	
6.10	4065	22894	

Columns – Allowable Concentric Axial Stresses and Loads

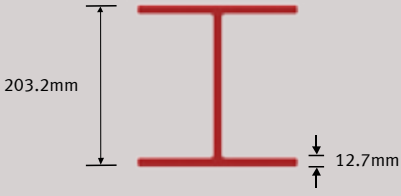
203.2 x 203.2 x 12.7mm WF-Beam			
	A	7425.79mm ²	
	r	49.02mm	
Effective Length (m)	F _a (kPa)	P _a (N)	
0.30	47060	349461	
0.46	45363	336854	
0.61	43665	324248	
0.76	41967	311641	
0.91	40270	299034	
1.07	38572	286427	
1.22	36874	273821	
1.37	35177	261214	
1.52	33479	248607	
1.68	31781	236000	
1.83	30083	223394	
1.98	28386	210787	
2.13	26688	198180	
2.29	24990	185573	
2.44	23293	172967	
2.59	21595	160360	
2.74	19897	147753	
2.90	18200	135146	
3.05	16502	122540	
3.20	14902	110656	
3.35	13578	100825	
3.51	12423	92248	
3.66	11409	84721	
3.81	10515	78079	
3.96	9721	72188	
4.12	9015	66940	
4.27	8382	62244	
4.42	7814	58025	
4.57	7302	54221	
4.72	6838	50780	
4.88	6418	47655	
5.03	6035	44811	
5.18	5685	42214	
5.33	5365	39836	
5.49	5071	37654	
5.64	4800	35646	
5.79	4551	33794	
5.94	4321	32084	
6.10	4107	30499	

Columns – Allowable Concentric Axial Stresses and Loads

254.0 x 254.0 x 9.5mm WF-Beam			
		A	7135.47mm ²
		r	60.45mm
Effective Length (m)	F _a (kPa)	P _a (N)	
0.30	17572	125384	
0.46	17274	123258	
0.61	16976	121133	
0.76	16678	119007	
0.91	16380	116881	
1.07	16082	114756	
1.22	15785	112630	
1.37	15487	110504	
1.52	15189	108379	
1.68	14891	106253	
1.83	14593	104128	
1.98	14295	102002	
2.13	13997	99876	
2.29	13699	97751	
2.44	13401	95625	
2.59	13103	93500	
2.74	12806	91374	
2.90	12508	89248	
3.05	12210	87123	
3.20	11912	84997	
3.35	11614	82871	
3.51	11316	80746	
3.66	11018	78620	
3.81	10720	76495	
3.96	10422	74369	
4.12	10125	72243	
4.27	9827	70118	
4.42	9529	67992	
4.57	9231	65867	
4.72	8933	63741	
4.88	8635	61615	
5.03	8337	59490	
5.18	8039	57364	
5.33	7741	55239	
5.49	7444	53113	
5.64	7146	50987	
5.79	6848	48862	
5.94	6550	46736	
6.10	6246	44567	

Columns – Allowable Concentric Axial Stresses and Loads

254.0 x 254.0 x 12.7mm WF-Beam		
	A	9361.27mm ²
	r	60.96mm
Effective Length (m)	F _a (kPa)	P _a (N)
0.30	30894	289205
0.46	30193	282646
0.61	29493	276088
0.76	28792	269529
0.91	28091	262970
1.07	27391	256411
1.22	26690	249852
1.37	25989	243294
1.52	25289	236735
1.68	24588	230176
1.83	23887	223617
1.98	23187	217058
2.13	22486	210500
2.29	21786	203941
2.44	21085	197382
2.59	20834	190823
2.74	19684	184264
2.90	18983	177706
3.05	18282	171147
3.20	17582	164588
3.35	16881	158029
3.51	16181	151471
3.66	15480	144912
3.81	14779	138353
3.96	14079	131794
4.12	13378	125235
4.27	12677	118677
4.42	11977	112118
4.57	11276	105559
4.72	10574	98989
4.88	9924	92899
5.03	9331	87354
5.18	8791	82291
5.33	8295	77656
5.49	7841	73402
5.64	7423	69488
5.79	7037	65879
5.94	6681	62544
6.10	6351	59456

Columns – Allowable Concentric Axial Stresses and Loads

304.8 x 304.8 x 12.7mm WF-Beam		
	A	11296.75mm ²
	r	72.90mm
Effective Length (m)	F _a (kPa)	P _a (N)
0.30	21750	245708
0.46	21411	241877
0.61	21072	238046
0.76	20733	234214
0.91	20394	230383
1.07	20055	226552
1.22	19715	222721
1.37	19376	218889
1.52	19037	215058
1.68	18698	211227
1.83	18359	207395
1.98	18020	203564
2.13	17681	199733
2.29	17341	195902
2.44	17002	192070
2.59	16663	188239
2.74	16324	184408
2.90	15985	180576
3.05	15646	176745
3.20	15307	172914
3.35	14967	169083
3.51	14628	165251
3.66	14289	161420
3.81	13950	157589
3.96	13611	153757
4.12	13272	149926
4.27	12932	146095
4.42	12593	142264
4.57	12254	138432
4.72	11915	134601
4.88	11576	130770
5.03	11237	126938
5.18	10898	123107
5.33	10558	119276
5.49	10219	115445
5.64	9980	111613
5.79	9541	107782
5.94	9202	103951
6.10	8863	100119

A 3D architectural rendering of a double web beam structure. The structure is composed of multiple parallel beams with internal webs, shown in a perspective view. The beams are light gray, and the background is a dark gray gradient. The text 'Double Web Beam' is overlaid on the right side of the image in a red, sans-serif font.

Double Web Beam

Columns – Allowable Concentric Axial Stresses and Loads

Part: 225 x 475 x 10 x 16mm Double Web Beam		
Part Number: F-P-DWB(225/475/10/16)		
	A	16060mm ²
	r	54.9mm
Effective Length (m)	F _a (kPa)	P _a (N)
3.05	20889	335477
3.20	18976	304755
3.35	17315	278079
3.51	15772	253298
3.66	14566	233930
3.81	13386	214979
3.96	12391	198999
4.12	11448	183855
4.27	10656	171135
4.42	9946	159733
4.57	9304	149422
4.72	8722	140075
4.88	8160	131050
5.03	7680	123341
5.18	7242	116307
5.33	6840	109850
5.49	6447	103539
5.64	6109	98111
5.79	5796	93084
5.94	5507	88442
6.10	5222	83865



Square Hollow Section

Columns – Allowable Concentric Axial Stresses and Loads

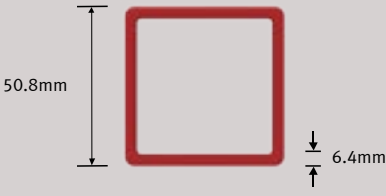
50.8 x 50.8 x 6.4mm Square Hollow Section		
	A	1122.58mm ²
	r	18.54mm
Effective Length (m)	F _a (kPa)	P _a (N)
0.30	54577	61267
0.46	47395	53201
0.61	40206	45135
0.76	33021	37068
0.91	25835	29002
1.07	19187	21539
1.22	14690	16491
1.37	11607	13030
1.52	9402	10554
1.68	7770	8722
1.83	6529	7329
1.98	5563	6245
2.13	4797	5385
2.29	4178	4691
2.44	3672	4123
2.59	3253	3652
2.74	2902	3257
2.90	2604	2924
3.05	2350	2639
3.20	2132	2393
3.35	1942	2181
3.51	1777	1995
3.66	1632	1832

Columns – Allowable Concentric Axial Stresses and Loads

38.1 x 38.1 x 6.4mm Square Hollow Section			
		A	800.0mm ²
		r	13.21mm
Effective Length (m)	F _a (kPa)	P _a (N)	
0.30	48773	39019	
0.46	38686	30949	
0.61	28599	22879	
0.76	19082	15265	
0.91	13251	10601	
1.07	9736	7789	
1.22	7454	5963	
1.37	5889	4712	
1.52	4770	3816	
1.68	3943	3154	
1.83	3313	2650	
1.98	2823	2258	
2.13	2434	1947	
2.29	2120	1696	
2.44	1863	1491	
2.59	1651	1321	

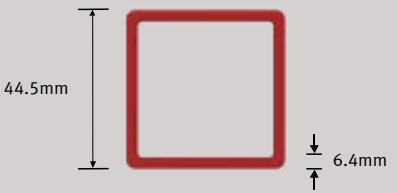
44.5 x 44.5 x 6.4mm Square Hollow Section			
		A	961.29mm ²
		r	15.75mm
Effective Length (m)	F _a (kPa)	P _a (N)	
0.30	52027	50015	
0.46	43367	41881	
0.61	35107	33748	
0.76	26647	25615	
0.91	18838	18109	
1.07	13840	13304	
1.22	10596	10186	
1.37	8372	8048	
1.52	6782	6519	
1.68	5605	5388	
1.83	4710	4527	
1.98	4013	3857	
2.13	3460	3326	
2.29	3014	2897	
2.44	2649	2547	
2.59	2347	2256	
2.74	2093	2012	
2.90	1879	1806	
3.05	1695	1630	

Columns – Allowable Concentric Axial Stresses and Loads

67.2 x 67.2 x 6.4mm Square Hollow Section		
	A	1445.16mm ²
	r	23.37mm
Effective Length (m)	F _a (kPa)	P _a (N)
0.30	57545	83161
0.46	51843	74922
0.61	46142	66682
0.76	40440	58443
0.91	34739	50203
1.07	29038	41964
1.22	23332	33718
1.37	18435	26642
1.52	14932	21580
1.68	12341	17834
1.83	10370	14986
1.98	8836	12769
2.13	7619	11010
2.29	6637	9591
2.44	5833	8430
2.59	5167	7467
2.74	4609	6660
2.90	4136	5978
3.05	3733	5395
3.20	3386	4893
3.35	3085	4459
3.51	2823	4079
3.66	2592	3746
3.81	2389	3453
3.96	2209	3192
4.12	2048	2960
4.27	1905	2753
4.42	1776	2566
4.57	1659	2398

Columns – Allowable Concentric Axial Stresses and Loads

76.2 x 76.2 x 6.4mm Square Hollow Section		
	A	1767.74mm ²
	r	28.70mm
Effective Length (m)	F _a (kPa)	P _a (N)
0.30	59964	105470
0.46	55022	97264
0.61	50380	89059
0.76	45738	80853
0.91	41096	72648
1.07	36455	64442
1.22	31813	56236
1.37	27171	48031
1.52	22527	39823
1.68	18618	32911
1.83	15644	27655
1.98	13330	23564
2.13	11494	20318
2.29	10012	17699
2.44	8800	15556
2.59	7795	13779
2.74	6953	12291
2.90	6240	11031
3.05	5632	9956
3.20	5108	9030
3.35	4654	8228
3.51	4258	7528
3.66	3911	6914
3.81	3604	6372
3.96	3332	5891
4.12	3090	5463
4.27	2873	5079
4.42	2679	4735
4.57	2503	4425
4.72	2344	4144
4.88	2200	3889
5.03	2069	3657
5.18	1949	3445
5.33	1839	3251
5.49	1738	3073
5.64	1646	2909

Columns – Allowable Concentric Axial Stresses and Loads

88.9 x 88.9 x 6.4mm Square Hollow Section			
		A	1767.74mm ²
		r	28.70mm
Effective Length (m)	F _a (kPa)	P _a (N)	
0.30	61000	127510	
0.46	57026	119203	
0.61	53053	110897	
0.76	49079	102591	
0.91	45105	94284	
1.07	41132	85978	
1.22	37158	77672	
1.37	33184	69365	
1.52	29210	61059	
1.68	25237	52753	
1.83	21347	44622	
1.98	18189	38021	
2.13	15684	32784	
2.29	13662	28558	
2.44	12008	25100	
2.59	10637	22234	
2.74	9488	19832	
2.90	8515	17800	
3.05	7685	16064	
3.20	6971	14571	
3.35	6351	13276	
3.51	5811	12147	
3.66	5337	11156	
3.81	4918	10281	
3.96	4547	9505	
4.12	4217	8814	
4.27	3921	8196	
4.42	3655	7640	
4.57	3416	7140	
4.72	3199	6686	
4.88	3002	6275	
5.03	2823	5900	
5.18	2659	5558	
5.33	2509	5245	
5.49	2372	4958	
5.64	2245	4694	
5.79	2129	4450	
5.94	2021	4225	
6.10	1921	4016	

Columns – Allowable Concentric Axial Stresses and Loads

101.6 x 101.6 x 6.4mm Square Hollow Section			
		A	2412.90mm ²
		r	38.86mm
Effective Length (m)	F _a (kPa)	P _a (N)	
0.30	62091	149819	
0.46	58663	141547	
0.61	55234	133275	
0.76	51806	125003	
0.91	48378	116731	
1.07	44949	108458	
1.22	41521	100186	
1.37	38093	91914	
1.52	34665	83642	
1.68	31236	75370	
1.83	27808	67098	
1.98	24380	58826	
2.13	21071	50842	
2.29	18355	44289	
2.44	16132	38926	
2.59	14290	34481	
2.74	12747	30756	
2.90	11440	27604	
3.05	10325	24912	
3.20	9365	22596	
3.35	8533	20589	
3.51	7807	18837	
3.66	7170	17300	
3.81	6608	15944	
3.96	6109	14741	
4.12	5665	13669	
4.27	5268	12710	
4.42	4911	11849	
4.57	4589	11072	
4.72	4297	10369	
4.88	4033	9731	
5.03	3792	9151	
5.18	3573	8620	
5.33	3371	8135	
5.49	3187	7689	
5.64	3017	7279	
5.79	2860	6901	
5.94	2715	6552	
6.10	2581	6228	

Columns – Allowable Concentric Axial Stresses and Loads

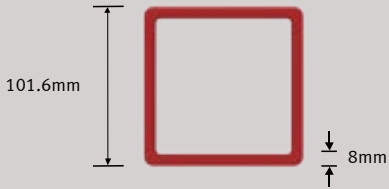
101.6 x 101.6 x 8mm Square Hollow Section		
	A	2995.2mm ²
	r	38.351358mm
Effective Length (m)	F _a (kPa)	P _a (N)
0.30	91014	272605
0.61	91014	272605
0.91	91014	272605
1.22	91014	272605
1.52	86198	258181
1.83	59860	179292
2.13	43979	131725
2.44	33671	100852
2.74	26604	79685
3.05	21550	64545
3.35	17810	53343
3.66	14965	44823
3.96	12751	38192
4.27	10995	32931
4.57	9578	28687

Columns – Allowable Concentric Axial Stresses and Loads

101.6 x 101.6 x 9.5mm Square Hollow Section		
	A	3503.22mm ²
	r	37.59mm
Effective Length (m)	F _a (kPa)	P _a (N)
0.30	61589	216707
0.46	58315	204291
0.61	54771	191875
0.76	51227	179459
0.91	47683	167043
1.07	44139	154628
1.22	40595	142212
1.37	37050	129796
1.52	33506	117830
1.68	29962	104964
1.83	26418	92548
1.98	22866	80105
2.13	19716	69070
2.29	17175	60168
2.44	15095	52882
2.59	13372	46843
2.74	11927	41783
2.90	10705	37501
3.05	9661	33844
3.20	8763	30698
3.35	7985	27971
3.51	7305	25591
3.66	6709	23503
3.81	6183	21660
3.96	5717	20026
4.12	5301	18570
4.27	4929	17268
4.42	4595	16097
4.57	4294	15042
4.72	4021	14087
4.88	3774	13220
5.03	3549	12431
5.18	3343	11711
5.33	3155	11051
5.49	2982	10446
5.64	2823	9889
5.79	2676	9375
5.94	2541	8901
6.10	2415	8461

Columns – Allowable Concentric Axial Stresses and Loads

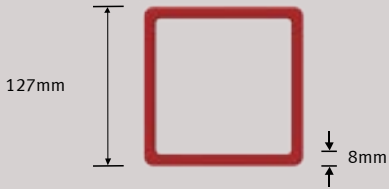
127 x 127 x 8mm Square Hollow Section		
	A	3808mm ²
	r	48.691204mm
Effective Length (m)	F _a (kPa)	P _a (N)
0.30	91014	346581
0.61	227535	866453
0.91	227535	866453
1.22	227535	866453
1.52	215495	820606
1.83	149650	569866
2.13	109947	418677
2.44	84178	320549
2.74	66511	253274
3.05	53874	205152
3.35	44524	169547
3.66	37412	142466
3.96	31878	121391
4.27	27487	104669
4.57	23944	91178

Columns – Allowable Concentric Axial Stresses and Loads

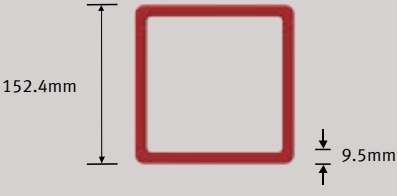
152.4 x 153.4 x 9.5mm Square Hollow Section		
	A	5335.47mm ²
	r	58.17mm
Effective Length (m)	F _a (kPa)	P _a (N)
0.30	51967	277266
0.46	50371	26873
0.61	48775	260239
0.76	47179	251725
0.91	45584	243211
1.07	43988	234697
1.22	42392	226183
1.37	40797	217669
1.52	39201	209155
1.68	37605	200641
1.83	36009	192127
1.98	34414	183613
2.13	32818	175099
2.29	31222	166585
2.44	29626	158071
2.59	28031	149557
2.74	26435	141043
2.90	24839	132529
3.05	23129	123407
3.20	20979	111934
3.35	19115	101989
3.51	17489	93313
3.66	16062	85699
3.81	14803	78980
3.96	13686	73022
4.12	12691	67713
4.27	11801	62963
4.42	11001	58695
4.57	10280	54847
4.72	9627	51366
4.88	9035	48206
5.03	8496	45328
5.18	8003	42701
5.33	7552	40296
5.49	7139	38089
5.64	6758	36057
5.79	6407	34185
5.94	6083	32454
6.10	5782	30852

Rectangular Hollow Section

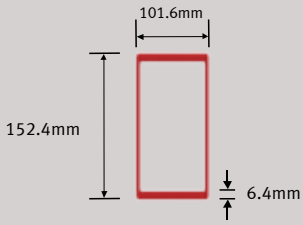

Columns – Allowable Concentric Axial Stresses and Loads

152.4 x 101.6 x 6.4mm Rectangular Hollow Section		
	A	3019.3mm ²
	r	40.89mm
Effective Length (m)	F _a (kPa)	P _a (N)
0.30	34263	103453
0.46	33000	99638
0.61	31736	95823
0.76	30473	92008
0.91	29209	88193
1.07	27946	84378
1.22	26682	80563
1.37	25419	76748
1.52	24155	72933
1.68	22892	69118
1.83	21628	65303
1.98	20365	61488
2.13	19101	57673
2.29	17838	53858
2.44	16574	50043
2.59	15311	46228
2.74	14047	42413
2.90	12668	38248
3.05	11433	34519
3.20	10370	31310
3.35	9448	28528
3.51	8645	26101
3.66	7939	23972
3.81	7317	22092
3.96	6765	20426
4.12	6273	18941
4.27	5833	17612
4.42	5438	16418
4.57	5081	15342
4.72	4759	14368
4.88	4466	13484
5.03	4199	12679
5.18	3956	11944
5.33	3733	11272
5.49	3529	10654
5.64	3340	10086
5.79	3167	9562
5.94	3007	9078
6.10	2858	8630

SPACE GASS Input Guide

SPACE GASS Input Guide

With the increasing popularity of SPACE GASS with the engineering and planning community at large, Treadwell is aware that it essential to aid users and make usage of this multi-purpose 3D analysis and design program simpler with our product guide. Instructions are tabulated step by step below on how to use our tables with the program.

Instructions

Under the Section segment:

On the second line:

1. **A** refers to Cross Sectional Area found in all products under Sectional Properties.
2. **J** refers to Torsion Constant found in all products under Sectional Properties.
3. **I_y** refers to moment of inertia about the Y axis found in all products under Sectional Properties.
4. **I_z** refers to moment of inertia about the X axis found in all products under Sectional Properties.
5. **A_y** refers to shear area. This can be left as zero.
6. **A_z** refers to shear area. This can be left as zero.
7. **Alpha** does not need to be altered.
8. **Mark** refers to section mark. This is not important for design.

Under the Material segment:

1. The first box refers to the material number.
2. The second box refers to the material name.
3. E refers to the Modulus of Elasticity found on pages 10 & 12 under Coupon Properties.
4. Poisson's refers to the Poisson's Ratio of FRP which is 0.23.
5. Mass Density refers to Density found on pages 10 & 12 under Coupon Properties.
6. Temp. Coefficient refers to the Coefficient of Thermal Expansion, LW, found on pages 10 & 12 under Coupon Properties.
7. F'c refers to the compressive strength of concrete which is 0.

Edit/Query Member												
Member	Type	Cable Len	Chord Length	Angle	Node	Axis						Close
1	Normal	0	10	Direction: 0	N/A	N/A						Cancel
End A:	Node	Fixty	Trans	Rot	y Stiffness	z Stiffness						Results
1	1	FFFFFF	x y z	x y z	0	0						Help
End B:	Node	Fixty	Trans	Rot	y Stiffness	z Stiffness						Regen
2	2	FFFFFF	x y z	x y z	0	0						
Section:	A	J	I _y	I _z	A _y	A _z	Alpha	Mark				
1	0	0	0	0	0	0	0					
Material:	E	Poisson's	Mass Dens	Temp Coeff	F'c							
1	0	0	0	0	0							

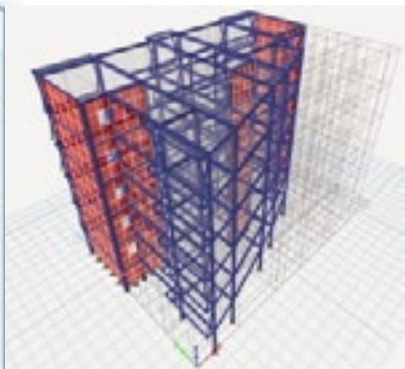

Corrosion Guide



Corrosion Guide

Information contained in this guide is based on data collected from several years of actual industrial applications. Recommendations are based on conservative evaluations of the changes which occur in certain properties of replicate laminates after exposures of one year or longer, both in the laboratory and the field.

Temperatures are neither the minimum nor the maximum but represent standard test conditions (Room Temperature & 70°C). The products may be suitable at higher temperatures but individual test data should be

required to establish such suitability. Contact Treadwell for any special applications that you may have.

The recommendations (• : resistant – :not resistant) contained in this specification sheet are made without guarantee or representation as to results. We suggest that you evaluate these recommendations and suggestions in your own laboratory or actual field trial prior to use. Our responsibility for claims arising from breach of warranty, negligence, or otherwise **is limited to the purchase price of the material.**

Chemical	I-Series		V-Series	
	Room Temp	70°C	Room Temp	70°C
Acetaldehyde	–	–	–	–
Acetic Acid 0-25%	•	•	•	•
Acetic Acid 25-50%	•	–	•	•
Acetic Anhydride	–	–	–	–
Acetone	–	–	–	–
Acrylonitrile	–	–	–	–
Alcohol, Butyl	–	–	•	–
Alcohol, Ethyl 10%	–	–	•	66
Alcohol, Ethyl 100%	–	–	•	–
Alcohol, Isopropyl 10%	–	–	•	66
Alcohol, Isopropyl 100%	–	–	•	–
Alcohol, Methyl 10%	–	–	•	66
Alcohol, Methyl 100%	–	–	–	–
Alcohol, Methyl Isobutyl	–	–	•	66
Alcohol, Secondary Butyl	–	–	•	66
Alum	•	•	•	•
Aluminium Chloride	•	•	•	•
Aluminium Hydroxide	•	–	•	49
Aluminium Nitrate	•	•	•	•
Aluminium Potassium Sulfate	•	•	•	•
Ammonia, Aqueous 0-10%	–	–	•	38
Ammonia, Gas	–	–	•	38
Ammonium Bicarbonate	•	–	•	49
Ammonium Bisulfite	–	–	•	49
Ammonium Carbonate	–	–	•	49
Ammonium Citrate	•	–	•	49
Ammonium Fluoride	–	–	•	49
Ammonium Hydroxide 5%	•	–	•	49
Ammonium Hydroxide 10%	•	–	•	49
Ammonium Hydroxide 20%	–	–	•	49
Ammonium Nitrate	•	•	•	49
Ammonium Persulfate	–	–	•	49
Ammonium Phosphate	–	–	•	49
Ammonium Sulfate	•	•	•	•
Arsenious Sulfate	•	–	•	•
O-Benzoyl Benzoic Acid	–	–	•	•

Chemical	I-Series		V-Series	
	Room Temp	70°C	Room Temp	70°C
Barium Carbonate	•	–	•	•
Barium Chloride	•	–	•	•
Barium Hydroxide	–	–	•	49
Barium Sulfate	•	•	•	•
Barium Sulfide	–	–	•	•
Beer	•	–	•	49
Benzene	–	–	–	–
5% Benzene in Kerosene	•	–	•	•
Benzene Sulfonic Acid	•	•	•	•
Benzoic Acid	•	–	•	•
Benzyl Alcohol	–	–	•	–
Benzyl Chloride	–	–	–	–
Brass Plating Solution:				
– 3% Copper Cyanide	–	–	•	•
– 6% Sodium Cyanide	–	–	•	•
– 1% Zinc Cyanide	–	–	•	•
– 3% Sodium Carbonate	–	–	•	•
Butyl Acetate	–	–	–	–
Butyric Acid 0-50%	•	–	•	•
Butylene Glycol	•	•	•	•
Cadmium Chloride	•	–	•	•
Cadmium Cyanide Plating Soln:				
– 3% Cadmium Oxide	–	–	•	49
– 6% Sodium Cyanide	–	–	•	49
– 1% Caustic Soda	–	–	•	49
Calcium Bisulfate	•	•	•	•
Calcium Carbonate	•	–	•	•
Calcium Chlorate	•	•	•	•
Calcium Chloride	•	•	•	•
Calcium Hydroxide	•	–	•	49
Calcium Hypochlorite	•	–	•	49
Calcium Nitrate	•	•	•	•
Calcium Sulfate	•	•	•	•
Calcium Sulfite	•	•	•	•
Caprylic Acid	•	–	•	•
Carbon Dioxide	•	•	•	•

Chemical	I-Series		V-Series	
	Room Temp	70°C	Room Temp	70°C
Carbon Disulfide	–	–	–	–
Carbon Monoxide	•	•	•	•
Carbon Tetrachloride	–	–	•	38
Carbon Acid	•	–	•	•
Castor Oil	•	•	•	•
Carbon Methyl Cellulose	–	–	•	49
Chlorinated Wax	–	–	•	•
Chlorine Doixide/Air	•	–	•	•
Chlorine Dioxide, Wet Gas	–	–	•	•
Chlorine, Dry Gas	–	–	•	•
Chlorine, Wet Gas	–	–	•	•
Chlorine, Liquid	–	–	–	–
Chlorine, Water	–	–	•	•
Chloroacetic Acid 0-50%	–	–	•	38
Chlorobenzene	–	–	–	–
Chloroform	–	–	–	–
Chlorosulfonic Acid	–	–	–	–
Chromic Acid 20%	–	–	•	49
Chromic Acid 30%	–	–	–	–
Chromium Sulfate	•	•	•	•
Citric Acid	•	•	•	•
Coconut Oil	•	–	•	•
Copper Chloride	•	•	•	•
Copper Cyanide	–	–	•	•
Copper Fluoride	–	–	•	•
Copper Nitrate	•	•	•	•
Copper Plating Solution:				
– Copper Cyanide	–	–	•	•
– 10.5% Copper	–	–	•	•
– 4% Copper Cyanide	–	–	•	•
– 6% Rochelle Salts	–	–	•	•
Copper Brite Plating:				
– Caustic Cyanide	–	–	•	38
Copper Plating Solution:				
– 45% Copper Fluorobrate	–	–	•	•
– 19% Copper Sulfate	–	–	•	•
– 8% Sulfuric Acid	–	–	•	•
Copper Matte Dipping Bath:				
– 30% Ferric Chloride	–	–	•	•
– 19% Hydrochloric	–	–	•	•
Copper Pickling Bath:				
– 10% Ferric Sulfate	–	–	•	•
– 10% Sulfuric Acid	–	–	•	•
Copper Sulfate	•	•	•	•
Corn Oil	•	–	•	•
Corn Starch-Slurry	•	–	•	•

Chemical	I-Series		V-Series	
	Room Temp	70°C	Room Temp	70°C
Corn Sugar	•	–	•	•
Cottonseed Oil	•	–	•	•
Crude Oil, Sour	•	–	•	•
Crude Oil, Sweet	•	–	•	•
Cyclohexane	•	–	•	49
Detergents, Sulfonated	•	–	•	•
Di-Ammonium Phosphate	•	–	•	•
Dibromophenol	–	–	–	–
Dibutyl Ether	–	–	•	49
Dichloro Benzene	–	–	–	–
Dichloroethylene	–	–	–	–
Diesel Fuel	•	–	•	•
Diethylene Glycol	•	–	•	•
Dimethyl Phthalate	–	–	•	•
Diocyl Phthalate	–	–	•	•
Diprophylene Gylcol	•	–	•	•
Dodecyl Alcohol	–	–	•	•
Esters, Fatty Acids	•	•	•	•
Ethyl Acetate	–	–	–	–
Ethyl Benzene	–	–	–	–
Ethyl Ether	–	–	–	–
Ethylene Gylcol	•	•	•	•
Ethylene Dichloride	–	–	–	–
Fatty Acids	•	•	•	•
Ferric Chloride	•	•	•	•
Ferric Nitrate	•	•	•	•
Ferric Sulfate	•	•	•	•
Ferrous Chloride	•	•	•	•
Ferrous Nitrate	•	•	•	•
Ferrous Sulfate	•	•	•	•
8-8-8 Fertiliser	•	–	•	49
Fertiliser:				
– Urea Ammoium Nitrate	–	–	•	49
Fuel Gas	–	–	•	•
Fluoboric Acid	–	–	•	49
Fluosilicic Acid 0-20%	–	–	•	•
Formaldehyde	•	–	•	•
Formic Acid	•	–	•	•
Fuel Oil	•	–	•	•
Gas Natural	•	–	•	•
Gasoline, Auto	•	–	•	•
Gasoline, Aviation	•	–	•	•
Gasoline, Ethyl	•	–	•	•
Gluconic Acid	•	–	•	•
Gasoline, Sour	•	–	•	•
Glucose	•	•	•	•

Corrosion Guide

Chemical	I-Series		V-Series	
	Room Temp	70°C	Room Temp	70°C
Glycerine	•	•	•	•
Glycol, Ethylene	•	•	•	•
Glycol, Propylene	•	•	•	•
Glycolic Acid	•	–	•	•
Gold Plating Solution:				
– 63% Potassium Ferrocyanide	–	–	•	•
– 2% Potassium Gold Cyanide	–	–	•	•
– 8% Sodium Cyanide	–	–	•	•
Heptane	•	–	•	•
Hexane	•	–	•	•
Hexylene Glycol	•	•	•	•
Hydraulic Fluid	•	–	•	•
Hydrobromic Acid 0-25%	•	–	•	•
Hydrochloric Acid 0-37%	•	–	•	•
Hydrocyanic Acid	•	–	•	•
Hydrofluoric Acid 10%	–	–	•	–
Hydrofluosilicic Acid, 10%	–	–	•	•
Hydrogen Bromide, Wet Gas	–	–	•	•
Hydrogen Chloride, Dry Gas	–	–	•	•
Hydrogen Chloride, Wet Gas	–	–	•	•
Hydrogen Peroxide	–	–	•	49
Hydrogen Sulfide, Dry	•	–	•	•
Hydrogen Sulfide, Aqueous	•	–	–	•
Hydrogen Fluoride, Vapour	–	–	•	•
Hydrosulfite Bleach	–	–	•	49
Hydrochlorus Acid 0-10%	–	–	–	–
Iron Plating Solution:				
– 45% Fecl: 15% Cacl	–	–	•	•
– 20% Fecl: 11% (Nh4)2 So4	–	–	•	•
Iron And Steel Claeaning Bath:				
–9% Hydrochloric: 23% Sulfuric	–	–	•	•
Isopropyl Amine	–	–	•	38
Isopropyl Palmitate	•	•	•	•
Jet Fuel	•	–	•	•
Kerosene	•	–	•	•
Lactic Acid	•	–	•	•
Lauroryl Chloride	–	–	•	•
Lauric Acid	•	–	•	•
Lead Acetate	•	–	•	•
Lead Chloride	•	–	•	•
Lead Nitrate	•	–	•	•
Lead Plating Solution:				
–.8% Fluoboric, 0.4% Boric Acid	–	–	•	•
Levulinic Acid	•	–	•	•
Linseed Oil	•	•	•	•
Lithium Bromide	•	•	•	•

Chemical	I-Series		V-Series	
	Room Temp	70°C	Room Temp	70°C
Lithium Sulfate	•	•	•	•
Magnesium Bisulfite	•	–	•	•
Magnesium Carbonate	•	–	•	•
Magnesium Chloride	•	•	•	•
Magnesium Hydroxide	–	–	•	60
Magnesium Nitrate	•	–	•	•
Magnesium Sulfate	•	•	•	•
Maleic Acid	•	•	•	•
Mercuric Chloride	•	–	•	•
Mercurous Chloride	•	–	•	•
Methylene Chloride	–	–	–	–
Methyl Ethyl Ketone	–	–	–	–
Methyl Isobutyl Carbitol	–	–	–	–
Methanol (See Alcohol)	•	–	•	•
Methyl Isobutyl Ketone	–	–	–	–
Methyl Styrene	–	–	–	–
Mineral Oils	•	•	•	•
Molybdenum Disulfide	•	–	•	•
Monochloro Acetic Acid	–	–	–	–
Monoethanolamine	–	–	–	–
Motor Oil	•	•	•	•
Myristic Acid	–	–	•	•
Naptha	•	•	•	•
Napthalene	•	–	•	•
Nickel Chloride	•	•	•	•
Nickel Nitrate	•	•	•	•
Nickel Plating:				
– 8% Lead, 0.8% Flouboric Acid	–	–	•	•
– 0.4% Boric Acid	–	–	•	•
Nickel Plating:				
– 11% Nickel Sulfate	•	–	•	•
– 2% Nickel Chloride	•	–	•	•
– 1% Boric Acid	•	–	•	•
Nickel Plating:				
– 44% Nickel Sulfate	•	–	•	•
– 4% Ammonium Chloride	•	–	•	•
– 4% Boric Acid	•	–	•	•
Nickel Sulfate	•	•	•	•
Nitric Acid 0-5%	•	•	•	•
Nitric Acid 20%	–	–	•	49
Nitric Acid Fumes	–	–	–	–
Nibrobenzene	–	–	–	–
Octanoci Acid	•	–	•	•
Oil, Sour Crude	•	•	•	•
Oil, Sweet Crude	•	•	•	•
Oleic Acid	•	•	•	•

Chemical	I-Series		V-Series	
	Room Temp	70°C	Room Temp	70°C
Oleum (Fuming Sulfuric)	–	–	–	–
Olive Oil	•	•	•	•
Oxalic Acid	•	•	•	•
Peroxide Bleach:				
– 25% Peroxide 95%	•	•	•	•
– 0.025% Epsom Salts	•	•	•	•
– 5% Sodium Silicate 42.Be	•	•	•	•
– 1.4% Sulfuric Acid 66.Be	•	•	•	•
Phenol	–	–	–	–
Phenol Sulfonic Acid	–	–	–	–
Phosphoric Acid	•	•	•	•
Phosphoric Acid Fumes	•	•	•	•
Phosphorous Pentoxide	•	•	•	•
Phosphorous Trichloride	–	–	–	–
Phthalic Acid	•	•	•	•
Pickling Acids (Sulfuric & Hydrochloric)	•	•	•	•
Picric Acid, Alcoholic	–	–	–	–
Polyvinyl Acetate Latex	•	–	•	•
Polyvinyl Alcohol	•	–	•	38
Polyvinyl Chloride Latex W/35 (Parts Dop)	–	–	•	49
Potassium Aluminium Sulfate	•	•	•	•
Potassium Bicarbonate	•	–	•	60
Potassium Bromide	•	–	•	38
Potassium Carbonate	•	–	•	60
Potassium Chloride	•	•	•	•
Potassium Dichromate	•	–	•	60
Potassium Ferricyanide	•	•	•	•
Potassium Ferrocyanide	•	•	•	•
Potassium Hydroxide	–	–	•	66
Potassium Nitrate	•	•	•	•
Potassium Permanganate	•	–	•	60
Potassium Persulfate	•	–	•	•
Potassium Sulfate	•	•	•	•
Propionic Acid 1-50%	–	–	•	49
Propionic Acid 50-100%	–	–	–	–
Propylene Glycol	•	•	•	•
Pulp Paper Mill Effluent	•	–	•	•
Pyridine	–	–	–	–
Salicylic Acid	–	–	•	60
Sebacic Acid	–	–	•	•
Selenious Acid	–	–	•	•
Silver Nitrate	•	•	•	•
Silver Plating Solution:				
– 44% Silver Cyanide	–	–	•	•
– 7% Potassium Cyanide	–	–	•	•
– 5% Sodium Cyanide	–	–	•	•

Chemical	I-Series		V-Series	
	Room Temp	70°C	Room Temp	70°C
– 2% Potassium Carbonate	–	–	•	•
Soaps	•	–	•	•
Sodium Acetate	•	–	•	•
Sodium Benzoate	•	–	•	•
Sodium Bicarbonate	•	•	•	•
Sodium Bifluoride	•	–	•	49
Sodium Bisulfate	•	•	•	•
Sodium Bisulfite	•	•	•	•
Sodium Bromate	•	•	•	60
Sodium Bromide	•	•	•	•
Sodium Carbonate 0-25%	•	–	•	•
Sodium Chlorate	•	–	•	•
Sodium Chloride	•	•	•	•
Sodium Chlorite	•	–	•	•
Sodium Chromite	•	•	•	•
Sodium Cyanide	•	–	•	•
Sodium Dichromate	•	•	•	•
Sodium Di-Phosphate	•	•	•	•
Sodium Ferricyanide	•	•	•	•
Sodium Fluoride	•	–	•	49
Sodium Fluoro Silicate	–	–	•	49
Sodium Hexametaphosphates	–	–	•	38
Sodium Hydroxide 0-5%	–	–	•	66
Sodium Hydroxide 5-25%	–	–	•	66
Sodium Hydroxide 50%	–	–	•	66
Sodium Hydrosulfide	•	–	•	•
Sodium Hypochlorite	•	–	•	66
Sodium Lauryl Sulfate	•	•	•	•
Sodium Mono-Phosphate	•	•	•	•
Sodium Nitrate	•	•	•	•
Sodium Silicate	•	–	•	•
Sodium Sulfate	•	•	•	•
Sodium Sulfide	•	–	•	•
Sodium Sulfite	•	–	•	•
Sodium Tetra Borate	•	•	•	•
Sodium Thiocyanate	–	–	•	•
Sodium Thiosulfate	•	–	•	•
Sodium Tripolyphosphate	•	–	•	•
Sodium Xylene Sulfonate	•	–	•	•
Sodium Solutions	•	–	•	•
Sodium Crude Oil	•	•	•	•
Soya Oil	•	•	•	•
Stannic Chloride	•	•	•	•
Stannous Chloride	•	•	•	•
Stearic Acid	•	•	•	•
Styrene	–	–	–	–

Corrosion Guide

Chemical	I-Series		V-Series	
	Room Temp	70°C	Room Temp	70°C
Sugar, Beet And Cane Liquor	•	–	•	•
Sugar, Sucrose	•	•	•	•
Sulfamic Acid	•	–	•	•
Sulfanilic Acid	•	–	•	•
Sulfated Detergents	•	–	•	•
Sulfur Dioxide, Dry Or Wet	–	–	•	•
Sulfur Trioxide/Air	–	–	•	•
Sulfuric Acid 0-30%	•	•	•	•
Sulfuric Acid 30-50%	–	–	•	•
Sulfuric Acid 50-70%	–	–	•	49
Sulfurous Acid	–	–	•	38
Superphosphoric Acid (76% P2 O5)	•	–	•	•
Tall Oil	•	–	•	60
Tannic Acid	•	–	•	66
Tartaric Acid	•	•	•	•
Thionyl Chloride	–	–	–	–
Tin Plating:				
– 18% Stannous Fluoroborate	–	–	•	•
– 7% Tin	–	–	•	•
– 9% Fluoroboric Acid	–	–	•	•
– 2% Boric Acid	–	–	•	•
Toluene	–	–	–	–
Toluene Sulfonic Acid	–	–	•	•
Transformer Oils:				
– Mineral Oil Types	•	•	•	•
– Chloro-Phenyl Types)	•	•	•	•
Trichlor Acetic Acid	•	–	•	•
Trichlorethylene	–	–	–	–
Trichloropenol	–	–	–	–
Tricresyl Phosphate	–	–	•	49

Chemical	I-Series		V-Series	
	Room Temp	70°C	Room Temp	70°C
Tridecylbenzene Sulfonate	•	–	•	•
Trisodium Phosphate	•	–	•	•
Turpentine	–	–	•	38
Urea	–	–	•	38
Vegetable Oils	•	•	•	•
Vinegar	•	•	•	•
Vinyl Acetate	–	–	–	–
Water:				
– Deionised	–	–	–	–
– Demineralised	•	•	•	•
– Distilled	•	•	•	•
– Fresh	•	•	•	•
– Salt	•	•	•	•
– Sea	•	•	•	•
White Liquor (Pulp Mill)	•	–	•	•
Xylene	–	–	–	–
Zinc Chlorate	•	•	•	•
Zinc Nitrate	•	•	•	•
Zinc Plating Solution:				
– 9% Zinc Cyanide	–	–	•	49
– 4% Sodium Cyanide	–	–	•	49
–9% Sodium Hydroxide	–	–	•	49
Zinc Plating Solution:				
– (49% Zinc Fluoroborate	•	–	•	•
– 5% Ammonium Chloride	•	–	•	•
– 6% Ammonium Fluoroborate	•	–	•	•
Zinc Sulfate	•	•	•	•

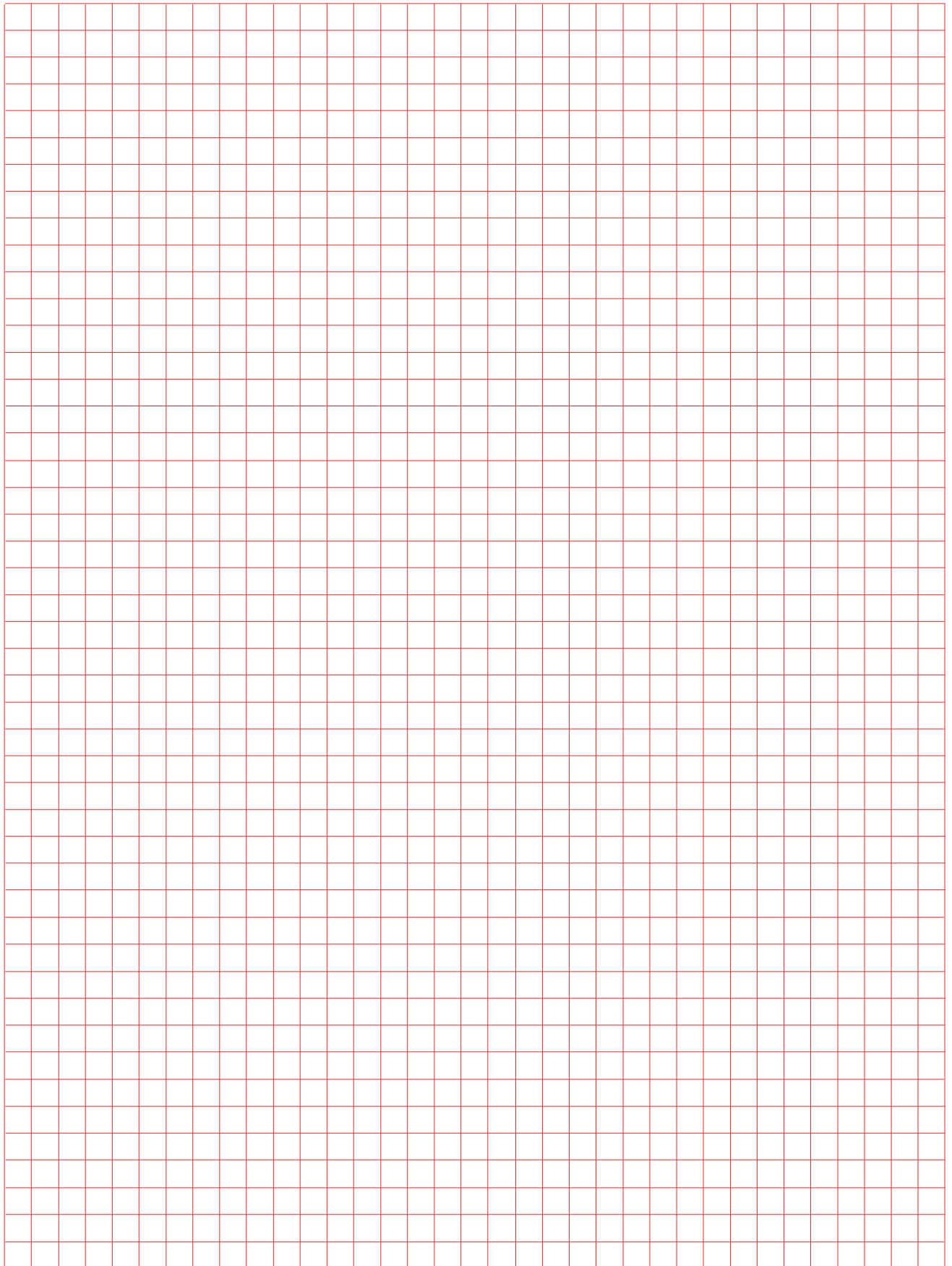

Notes

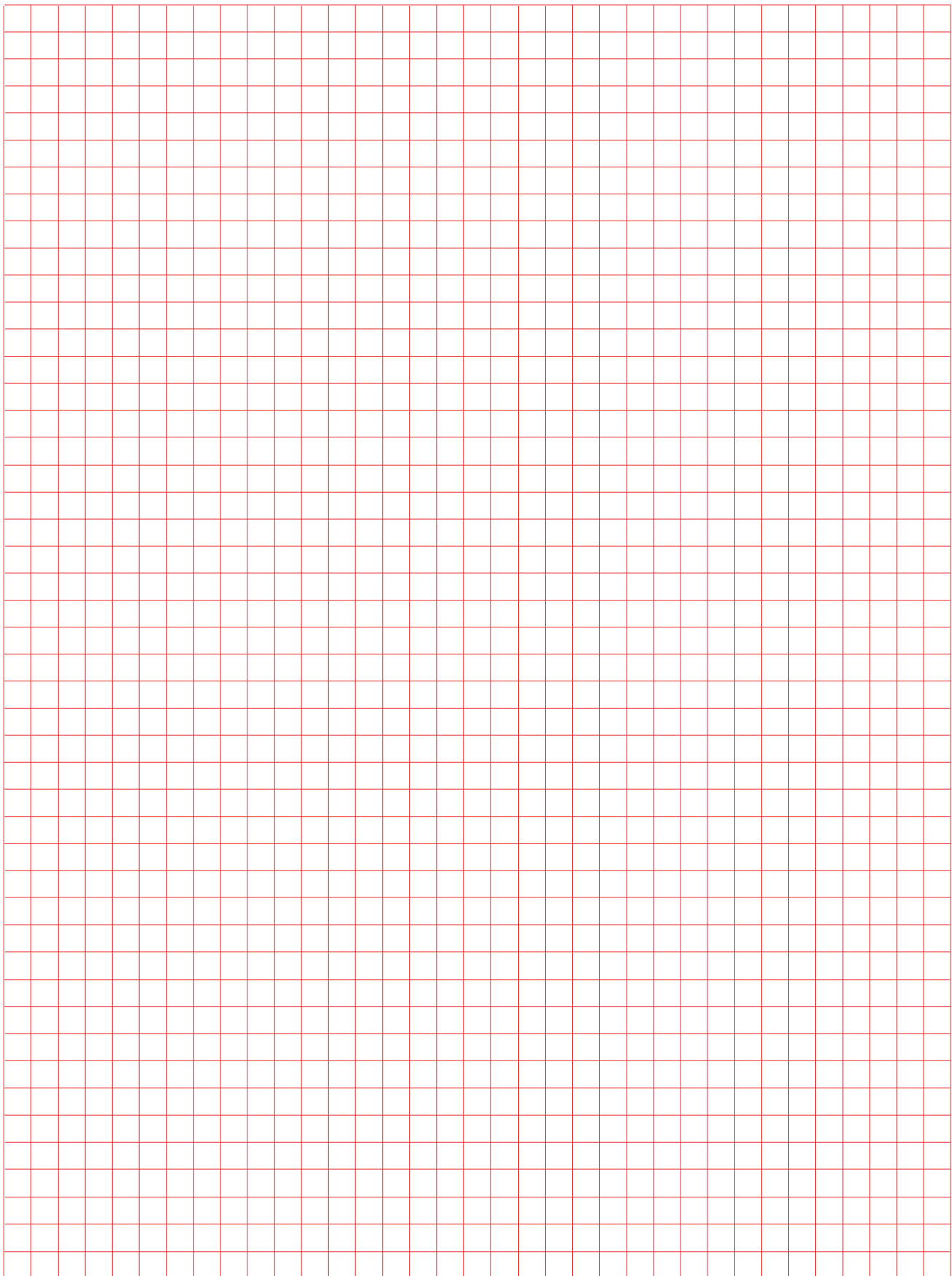

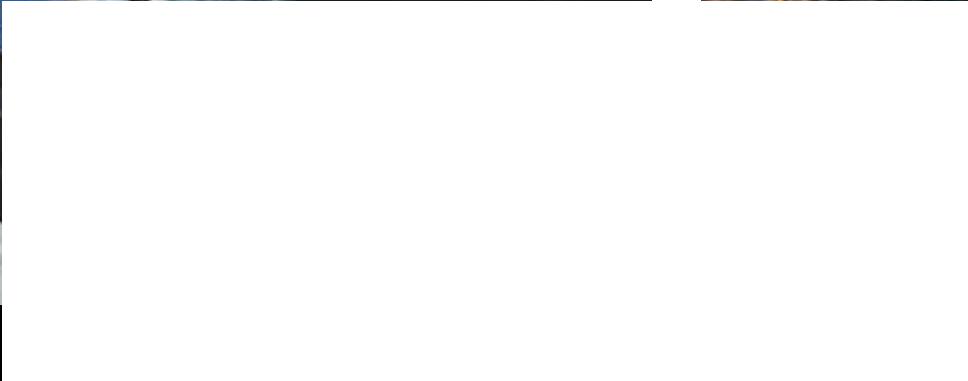
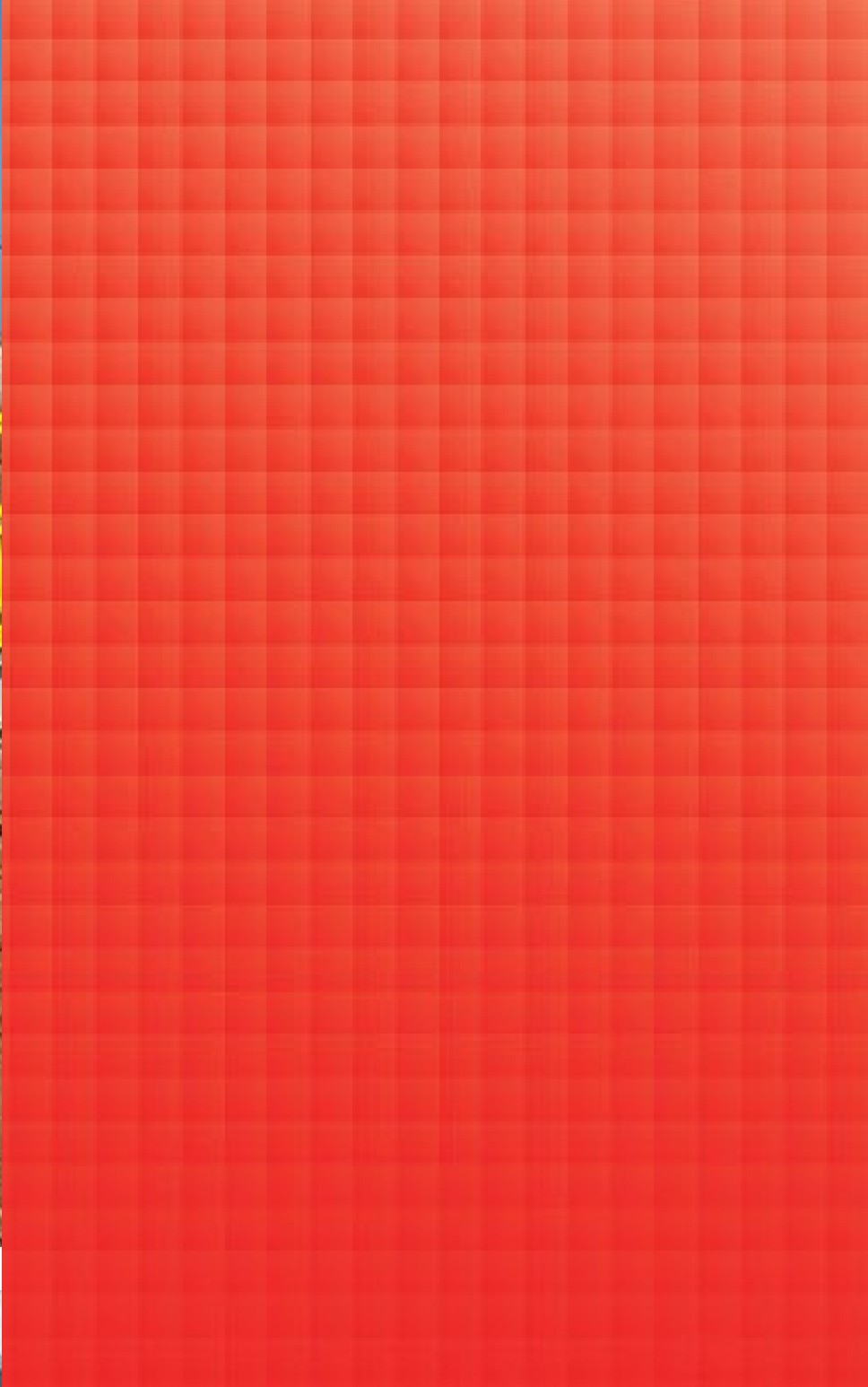

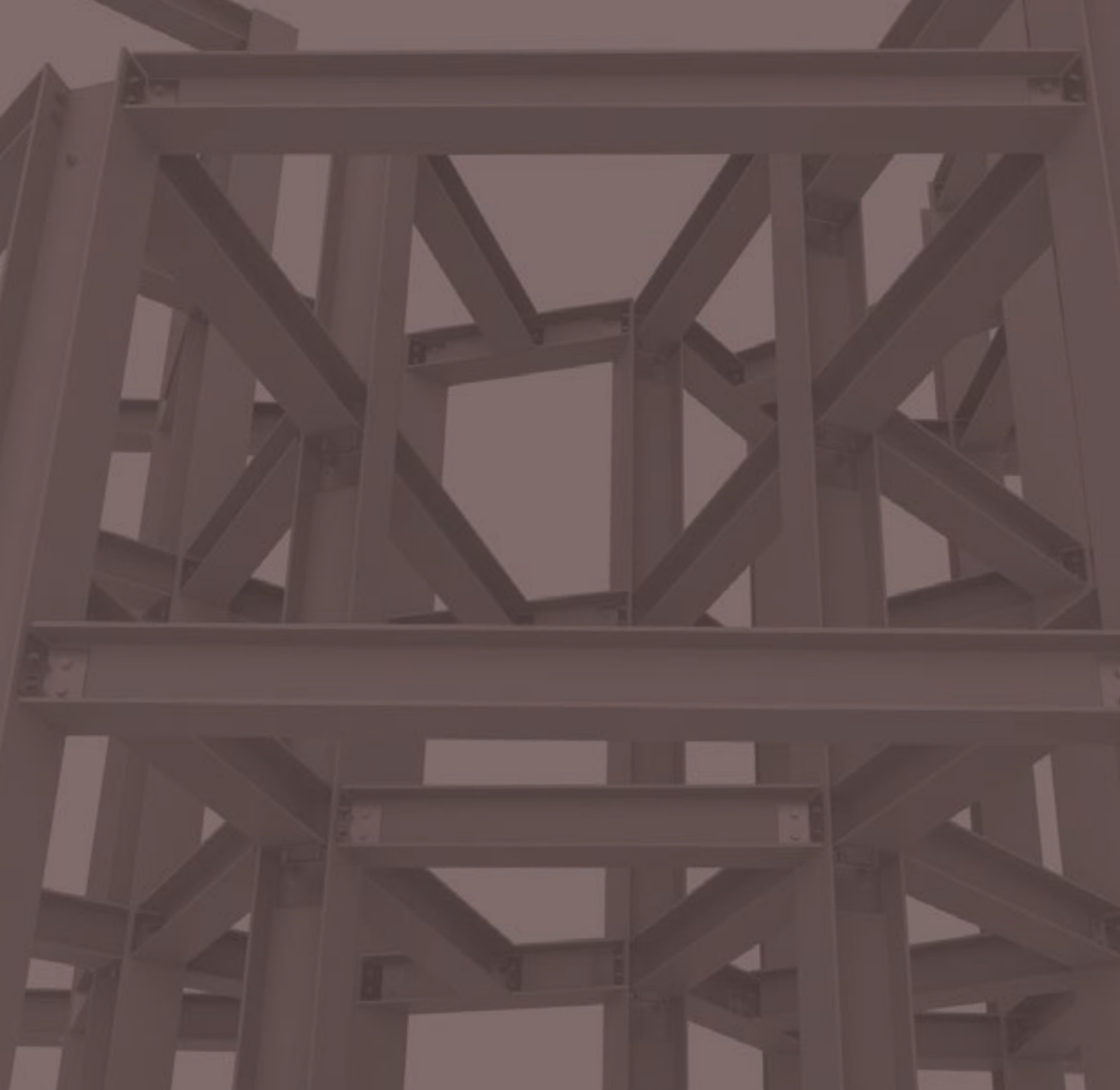

TREADWELL

Treadwell Access Systems, EX-Series®, GratEX®, MoultrEX® and ArchitEX™ are all registered brands of Treadwell Group Pty Ltd. All pictures and information are supplied as a guide only. The complete range of Treadwell products are developed, refined and made to meet and exceed stringent specifications for the worldwide market.

Important Note: Sales of products are subject to our Terms and Conditions which are available upon request. All specifications and photos are a guide only and are subject to change without notice. Please ring to confirm details. Treadwell products only comply with relevant standards mentioned within this publication when installed and used as they are designed to be.

